

102

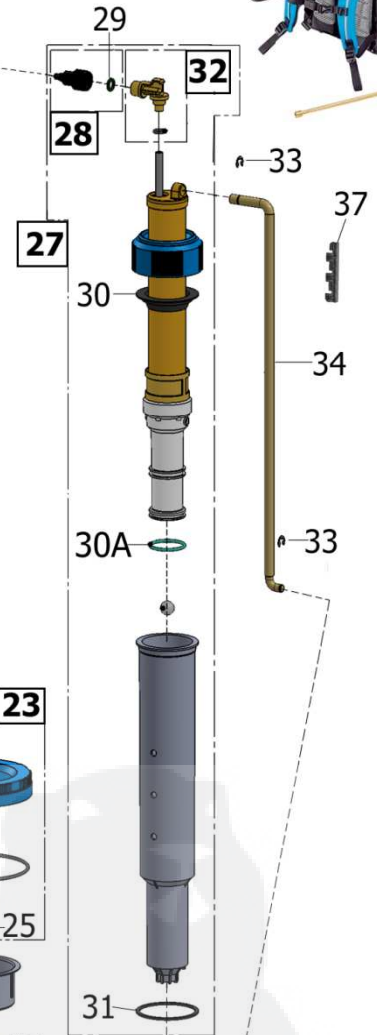

102

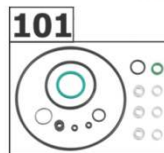
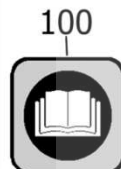

23

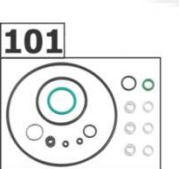
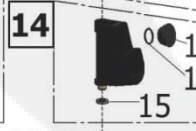
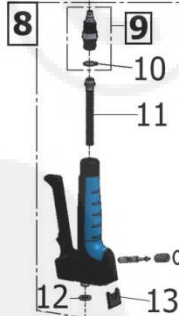
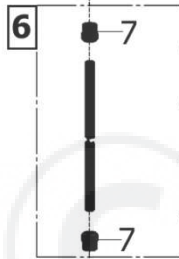
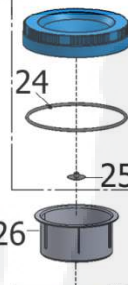

Technische Änderungen vorbehalten  
 Subject to technical changes  
 Sous réserve de modifications techniques

\*=im Dichtungssatz enthalten  
 included in gasket set  
 inclus dans le kit de réparation

<b>2/2</b>	Kolbenrückensprühgeräte		<b>Pro 1300</b>	<b>GLORIA®</b>
2014	Piston knapsack sprayer		Art.Nr.000058.0000	Geräte für Haus und Garten
Rev.02.2014	Vaporisateur à piston dorsaux			
Bild Nr. REF.N° POS.N°	BEST.-NR. PART-N° N° d. PIECE	BEZEICHNUNG	DESCRIPTION	Anzahl Qty. Qte.
1	728764.0000	Behälter 13 L mit Hebel vormontiert 000058	Tank 13 L and Lever Assy. cpl. 000058	1
2	728584.0000	Tragegestell Pro 1300	CARRING DEVICE Pro 1300	1
<b>6</b>	727412.0000	Spritzschlauch NW6x3x1200mm m.Schlauchanschl.	Spraying hose NW6x3x1200mm assy.	1
7	521400.0000	Schlauchanschlussmutter	Hose connection nut	2
<b>8</b>	728590.0000	Trigger TPA kpl.	Trigger TPA cpl.	1
<b>9</b>	722940.0000	Schlauchanschlusstülle kpl. m.Dichtung	Hose connecting socket cpl.	1
10	602230.0000	O-Ring 13 x 2 NBR	O-Ring 13 x 2 NBR	1
11	613320.0000	Filtersieb	Filter sieve	1
12	611170.0000	Dichtung 14x8x3	SEAL 14x8x3	1
13	536870.0000	Verschlusskappe z.TPR	Sealing cap TPR	1
<b>14</b>	723900.0000	Aufnahmestutzen mit Manometer	Pressure gauge cpl.	1
15	617070.0000	Dichtung Ø 13 x Ø 9 x 2	SEAL Ø 13 x Ø 9 x 2	1
16	536930.0000	Verschlussstopfen	Locking cap	1
17	501540.0000	O-Ring 18x1,5 (Perbunan)	O-RING 18X1.5 NBR (PERBU.) 72	1
<b>18</b>	700220.0000	Spritzrohr kpl	Spraying lance cpl.	1
19	634870.0000	Düse (G-H49-55)	Nozzle (G-H49-55)	1
20	606271.0000	Zerstäubereinsatz. fein	Sprayer insert fine	1
<b>21</b>	725830.0000	(SB) Hohlkegeldüse 1 mm kpl.	Hollow cone nozzle 1 mm cpl.	1
22	617070.0000	Dichtung Ø 13 x Ø 9 x 2	SEAL Ø 13 x Ø 9 x 2	1
<b>23</b>	728573.0000	Deckel kpl.	LID WITH SEAL AND VALVE ASSY.	1
24	610418.0000	Dichtung Deckel 126,6x3,53 NBR 70	SEAL FO LID 126,6x3,53 NBR 70	1
25	541268.0000	Membran Deckel	LID MEMBRAN	1
26	541269.0000	Sieb Ø 100mm	PLASTIC SIEVE Ø 100mm	1
<b>27</b>	728586.0000	Messing-Pumpe KRS Pro 1300 kpl	BRASS PUMP 13 L COMPLETE Pro 1300	1
<b>28</b>	728622.0000	Schlauchanschlusstülle kpl. KRS	HOSE CONNECTING PART CPL.	1
29	610392.0000	Flachdichtung 15x10x2 viton grün	FLAT SEAL 15x10x2 viton green	1
30	541374.0000	Pumpendichtung Pro 1300/1800	Pump seal Pro 1300/1800	1
30A	610421.0000	O-Ring 37,5x3,15 Viton 70	O-Ring 37,5x3,15 Viton 70	1
31	610419.0000	O-Ring 55,56 x 3,53 NBR 70	O-Ring 55,56 x 3,53 NBR 70	1
32	541366.0000	Winkelstück, schwarz	ELBOW, black	1
33	610377.0000	Sicherungsring DIN 6799 - 8	SAFTEY RING DIN 6799 - 8	2
34	541351.0000	Zugstange galZn, Ø 12 (000058)	GALVANIZED LEVER Ø 12 (000058)	1
<b>35</b>	977666.0000	Handgriff KRS Pro 1300/1800 kpl.	HANDLE KRS Pro 1300/1800 cpl.	1
<b>36</b>	705610.0000	Verlängerungsrohr	EXTENSION PIPE	1
37	541340.0000	Rohrklemmadapter 9 mm KRS	TUBE ADAPTER 9mm	1
38	610409.0000	PT Schraube EJOT KB30x10 WN 1412	PT SCREW EJOT KB30x10 WN 1412	3
100	977650.0000	Gebrauchsanleitung KRS Hobby/Pro	INSTRUCTION FOR USE KRS (Hobby/Pro)	1
<b>101</b>	728628.0000	Dichtungssatz Hobby 1800,Pro 1300/1800	GASKET SET Hobby 1800,Pro 1300/1800	1
<b>102</b>	977629.0000	Polybeutel kpl. (Schlauchleitung kpl.)	POLYBAG CPL. (hose line cpl.)	1
103	001100.0000	Sprühgeräte-Reiniger 250ml	CLEANING AGENT FOR SPRAYERS, 250 ml	Option