

CATALOGO PARTI DI RICAMBIO

TOSAERBA PROFESSIONALE

CAMBIO MECCANICO

MOD. 63 - 630

MOD. 67 - 670

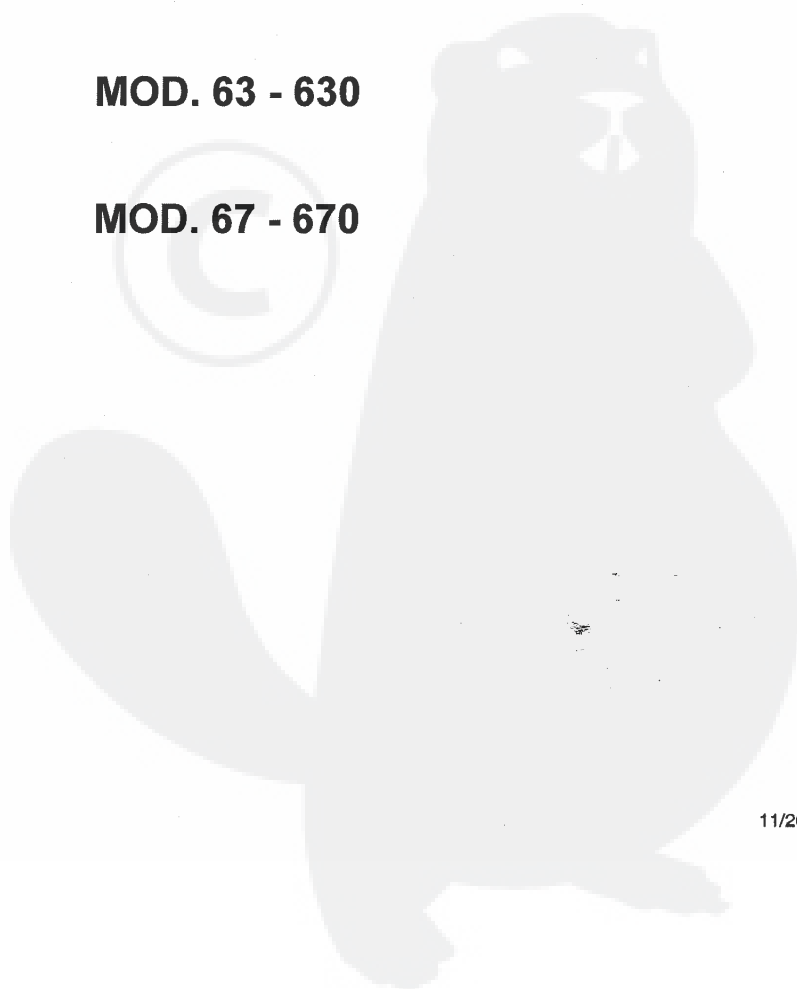

STEGOLA - TRASMISSIONI

TAV. 1

1	22.0050.900	10	34.1020.470	19	34.1010.110	28	85.9011.000	37	84.3993.070
2	34.1010.318	11	34.0010.150	20	34.1010.111	29	34.1010.225	39	34.1005.382
3	81.4645.000	12	84.3619.000	21	34.1010.107	30	85.8008.000	40	34.1005.384
4	84.3812.000	13	81.4530.080	22	81.4588.000	31	34.0005.219	41	34.1025.161 ●
5	34.1010.320	14	34.1010.332	23	84.3685.000	32	34.1012.309	42	34.1025.162 ●
6	34.1010.327	15	34.1010.319	24	86.2786.500	33	34.1012.307	43	34.1025.160 ●
7	34.1010.300	16	34.1010.330	25	34.1010.106	34	85.1350.000	44	34.1005.380
8	86.1931.000	17	81.4620.000	26	34.1010.103	35	34.1010.340	45	23.0050.205
9	84.3605.010	18	22.0010.910	27	34.1010.226	36	81.7640.000		● AVVIAMENTO EL.

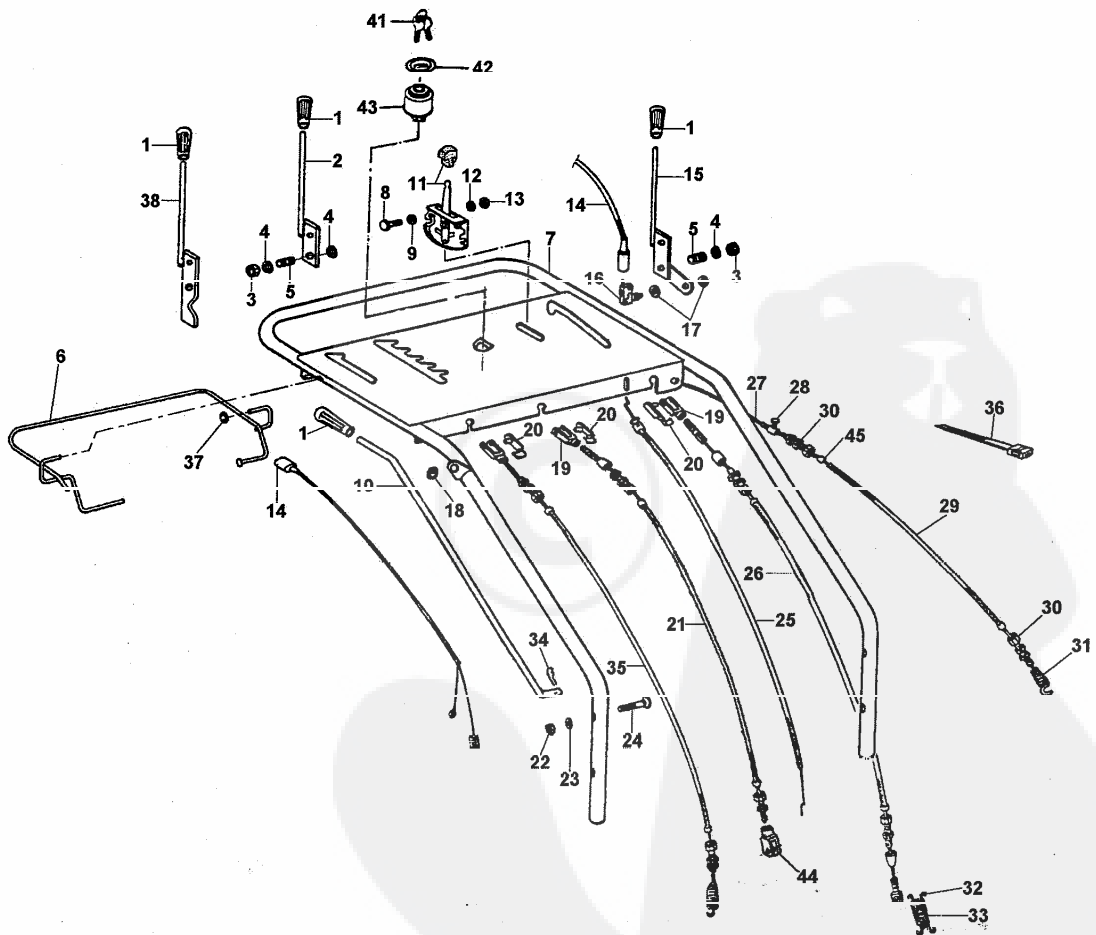

TELAIO - CAMBIO - RUOTE

TAV. 2

1	34.1005.297 (63)	17	86.2439.100	37	81.4574.000	57	34.1020.473	78	34.0025.151 ●
-	34.1005.296 (630)	18	34.1005.360	38	34.1005.382	58	27.0022.220	79	34.0025.125 ●
-	34.1005.293 (67)	19	81.4548.000	39	34.1005.384	59	81.4545.000	80	86.1998.000 ●
-	34.1005.292 (670)	20	34.0005.105	40	81.4642.000	60	84.3570.000	81	34.1012.341
2	34.1005.402 ▲	21	86.2300.000	41	34.0005.152	61	86.2845.000	82	84.3901.050
-	34.1005.404 ▲	22	81.4794.000	42	86.2944.000	62	81.4580.000	83	34.0005.216
3	34.1005.414	23	26.0050.200	44	66.5547.000	64	34.1005.410 (63-630)		
4	26.0050.219	24	34.0005.110	45	34.1020.422	65	84.3619.000	▲	63 - 67
5	86.1931.000	25	34.1005.130	46	34.1005.565	66	34.1020.450	▲	630 - 670
6	84.3605.010	26	34.1005.134	47	35.1005.220	68	34.1005.557	●	AVVIAMENTO EL.
7	81.4530.080	27	34.1005.132	48	34.1020.424	69	84.4110.000	□ →	MATR. 493981
8	34.0020.129	28	84.3994.000	49	81.4703.000	70	27.0010.145	■ →	MATR. 493982
9	86.2494.000	29	86.2741.000	50	34.1020.418	71	80.1042.000		
10	81.4644.000	30	84.3708.000	51	84.3818.000	72	34.0005.232 SX		
11	84.3685.000	31	81.4588.000	52	80.1116.000	-	34.0005.234 DX		
12	34.1025.105	32	86.3566.200	53	34.1005.388 □	73	34.1005.313		
13	34.1025.112	33	84.3667.000	-	34.1005.378 ■	74	34.1025.142 ●		
14	34.1025.125	34	34.1005.370	54	34.1020.476	75	34.0025.141 ●		
15	34.1025.114	35	34.1005.352	55	86.2438.040	76	34.0025.139 ●		
16	84.3843.070	36	85.1350.000	56	84.3622.000	77	34.0025.130 ●		

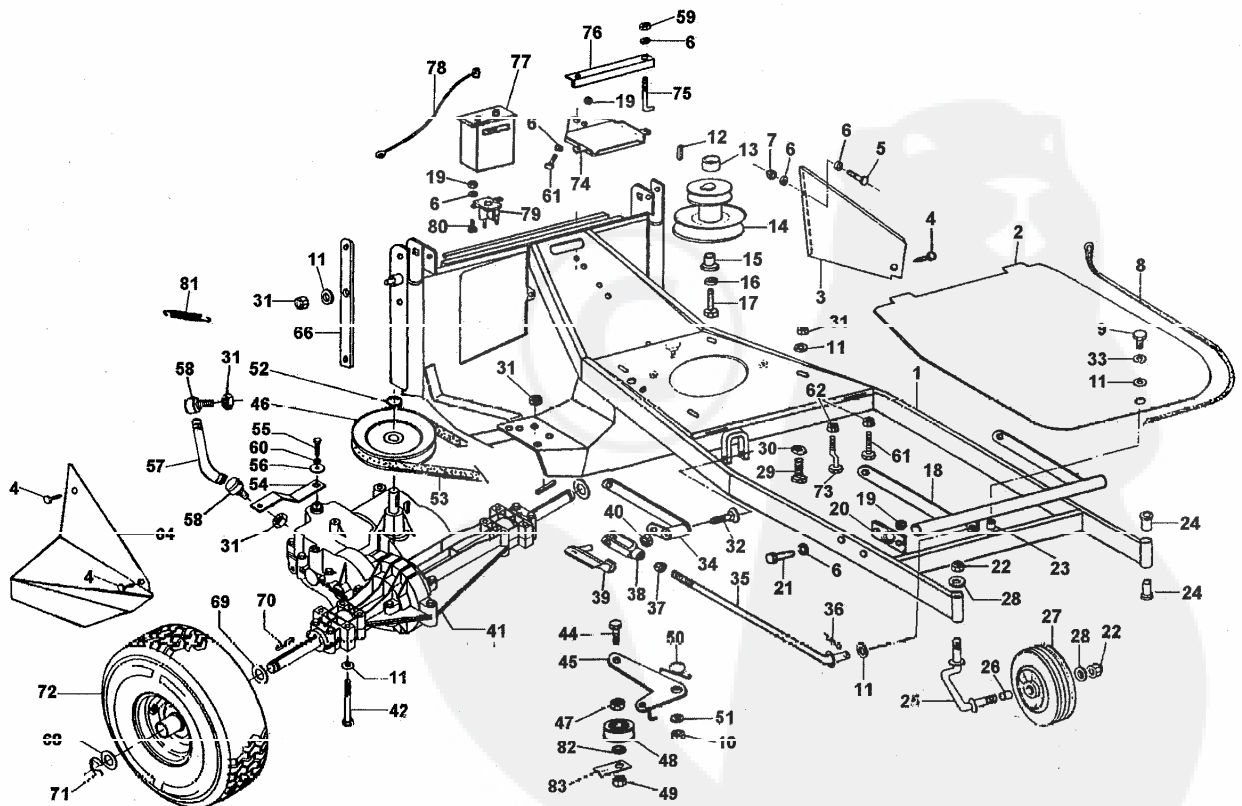

PIATTO - CESTO RACCOGLIERBA

TAV. 3

1	34.1020.391 (67-670)	18	84.3994.000	33	34.1020.361	49	34.1020.130 (67-670)
2	34.1020.176 (67-670)	19	34.0020.109	34	34.0020.111	50	84.6000.300
3	34.1020.190 (67-670)	20	34.1005.383 (63-630) □	35	81.4702.000	51	86.2439.000
4	34.1020.394 (67-670)	-	34.1005.394 (67-670) □	36	81.4530.080	52	34.1020.326 (63-630)
5	34.1020.396 (67-670)	-	34.1005.398 ■	37	34.1020.370	53	34.1020.322 (63-630)
6	34.1020.398 (67-670)	21	32.1005.217	38	86.1931.000	54	34.1020.310 (63-630)
7	04.0000.070 (07-070)	22	01.2046.000	39	34.1020.366 (63-630)	55	34.0020.122 (63-630)
8	86.2097.010 (67-670)	23	34.1020.352	-	34.1020.369 (67-670)	56	34.1020.328 (63-630)
9	84.3619.000 (67-670)	24	34.1020.353	40	86.3430.000	57	34.1020.366
10	81.4548.000 (67-670)	25	23.0330.209	41	26.1300.233	58	34.1020.365
11	34.1020.900 (67-670)	26	34.1020.350	42	34.1005.380	59	84.3884.000
12	22.0005.212	27	26.0050.202	43	86.3355.000	60	86.3750.000
13	86.2741.000 (67-670)	28	34.1020.060	44	84.3685.000		
14	84.3713.000 (67-670)	29	86.2952.000	45	34.1020.300 (67-670)	□ →	MATR. 493981
15	36.0005.220	30	81.4580.000	46	34.1020.349	■ →	MATR. 493982
16	81.4588.000 (67-670)	31	81.4645.000	47	86.2845.000		
17	81.4794.000	32	81.4642.000	48	34.0020.120		

