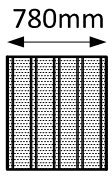
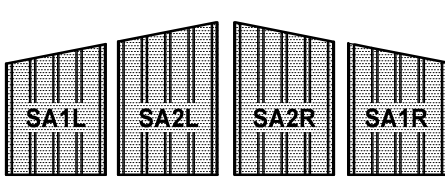
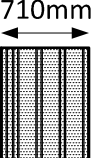
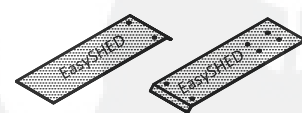
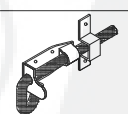
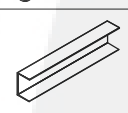
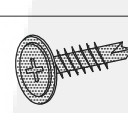
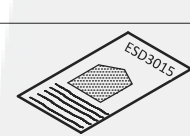
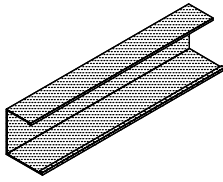
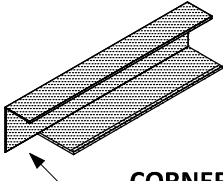
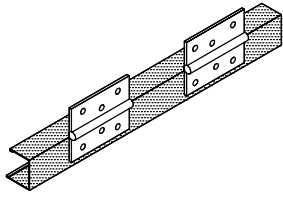
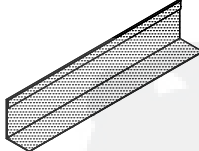
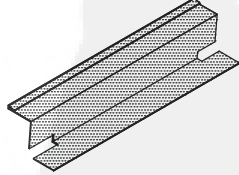
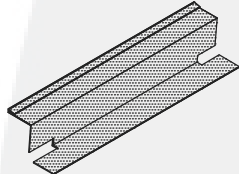

CHECK	QTY	DESCRIPTION	PART No.	DETAILS
<input type="checkbox"/>	4	1800mm WALL SHEET	SWR1	 <p>780mm</p>
<input type="checkbox"/>	2	2040mm DOOR SHEET	SD11	
<input type="checkbox"/>	4	1700mm ROOF SHEET	SR8	
<input type="checkbox"/>	4	ANGLE CUT WALL SHEETS	SA1L SA2L SA1R SA2R	 <p>4 SHEETS 780mm WIDE</p>
<input type="checkbox"/>	2	2100mm FRONT WALL SHEET	SN7	 <p>710mm</p> <p>SPECIAL NARROW WIDTH SHEET</p>
<input type="checkbox"/>	1	BAG OF ESD3015 ACCESSORIES		

ESD3015 BAG OF ACCESSORIES - LIST OF CONTENTS

<input type="checkbox"/>	1	DOOR PLATE - 2 HOLE	EDP2	
<input type="checkbox"/>	1	DOOR PLATE - 6 HOLE	EDP6	
<input type="checkbox"/>	3	DOOR LOCK + HASP	EPAH	
<input type="checkbox"/>	6	INTERNAL CHANNEL JOINERS	EICJ	
<input type="checkbox"/>	240	SELF DRILLING SCREWS	ESCREW	
<input type="checkbox"/>	1	ASSEMBLY INSTRUCTION	ESD3015	

NOTE: Where possible, some components have been marked with Part Numbers for easy identification. Other components not marked with Part Numbers can be easily identified by their description, sketches and sizes shown on the Packing List and throughout this instruction.

CHECK	QTY	DESCRIPTION	PART No.	DETAILS
<input type="checkbox"/>	1	U CHANNEL 2040mm	C2040	
<input type="checkbox"/>	2	U CHANNEL 1575mm	C1575	
<input type="checkbox"/>	2	U CHANNEL 1540mm	C1540	
<input type="checkbox"/>	2	U CHANNEL 1510mm	C1510	
<input type="checkbox"/>	4	U CHANNEL 1500mm	C1500	
<input type="checkbox"/>	4	U CHANNEL 777mm	C777	
<input type="checkbox"/>	8	U CHANNEL 1500mm	C1500N1	 CORNER CUT-OUT ONE END ONLY
<input type="checkbox"/>	2	U CHANNEL 2040mm WITH HINGES	C2040H	
<input type="checkbox"/>	2	L FLASHING 1700mm	L1700	
<input type="checkbox"/>	2	JAMB 2100mm	J2100	
<input type="checkbox"/>	1	JAMB 2040mm	J2040	
<input type="checkbox"/>	4	JAMB 1125mm	J1125	

EXPLODED VIEW OF COMPONENTS.

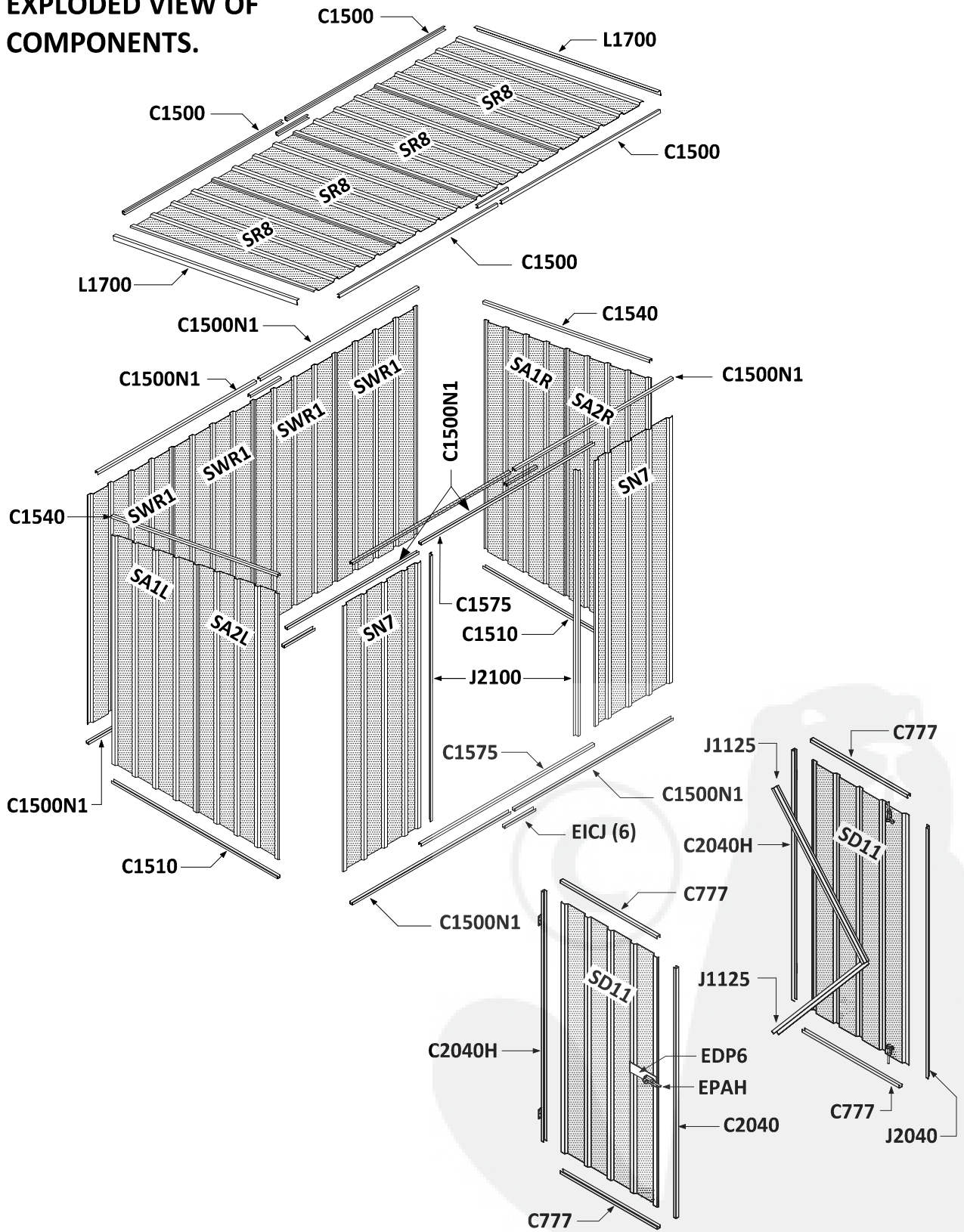

BEFORE YOU START!



Be a wise old owl and thoroughly read front to back of this instruction before commencing any assembly.

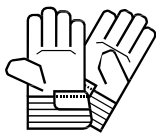

Wear safety gloves and glasses at all times to protect your hands from sharp metal edges and eyes from tiny airborne drilling debris.



Unpack the cartons, check off and familiarize yourself with all the components against the packing lists on the previous pages, then sort, separate and identify the various components.

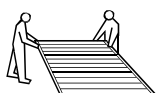

Two people are recommended when handling the completed roof & wall panels. Always carry the panels vertically with one person at each end.



Do not attempt to handle the panels during windy conditions. Sudden wind gusts may damage the panels or cause personal injury.

TOOLS REQUIRED



POWER
DRILL +



PHILLIPS HEAD
SCREWDRIVER



STEP
LADDER



3mm STEEL DRILL
10mm STEEL DRILL
10mm MASONRY DRILL

THE WORK AREA

Select a level work area to assemble the panels together.
Use your concrete slab or place a couple of planks on the ground.

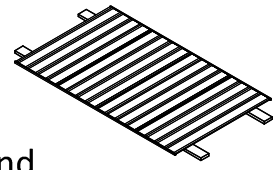

Alternatively, if you have a couple of trestles and four planks about 3000mm & 1800mm in length, fasten the planks to the top of the trestles. This will give you a good working platform and make the panel assembly process much easier.

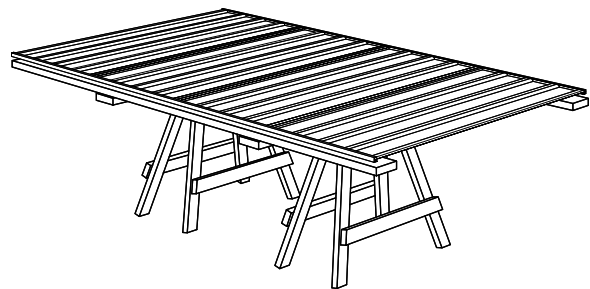
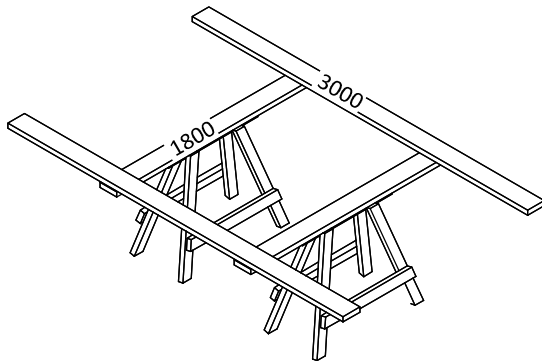

JOINING COMPONENTS TOGETHER



All components are assembled using the self drilling screws provided. With the aid of a Phillips Head driver bit inserted into a drill, these screws will self-drill each hole before drawing and locking the components together.

Set the drill at a moderate speed, locate the screw and push the drill sharply on to the components to create a starting point. Maintain firm load pressure until the screw has drilled and fastened.

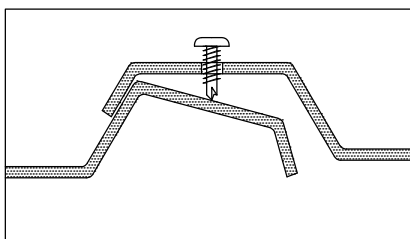

When lapping and joining the sheets together, as the screw drills through the first sheet, it may tend to push away the second sheet.

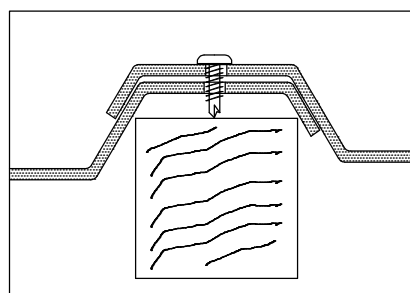

Hold a small block of timber under the bottom sheet to support the drilling pressure, allowing the screw to quickly drill and fasten the second sheet.

PRE-JOINING CHANNELS TOGETHER

As you commence the assembly process on the following pages, you will notice that some channels will need to be joined together together to make longer pieces, wherever you see the ****JOIN**** symbol.

A list of these channels is noted below, together with some simple instructions to assist the joining process.

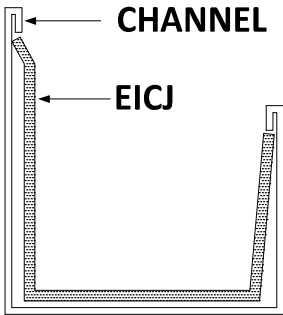

The channel joiners 'EICJ' supplied fit neatly inside the channels to be joined together, without the need for screws. Ensure that half of the 220mm long channel joiner is allocated to each channel when they are butted together. Handle these joined channels carefully until they attain full strength after being fastened to the roof and wall sheets as noted on following pages.

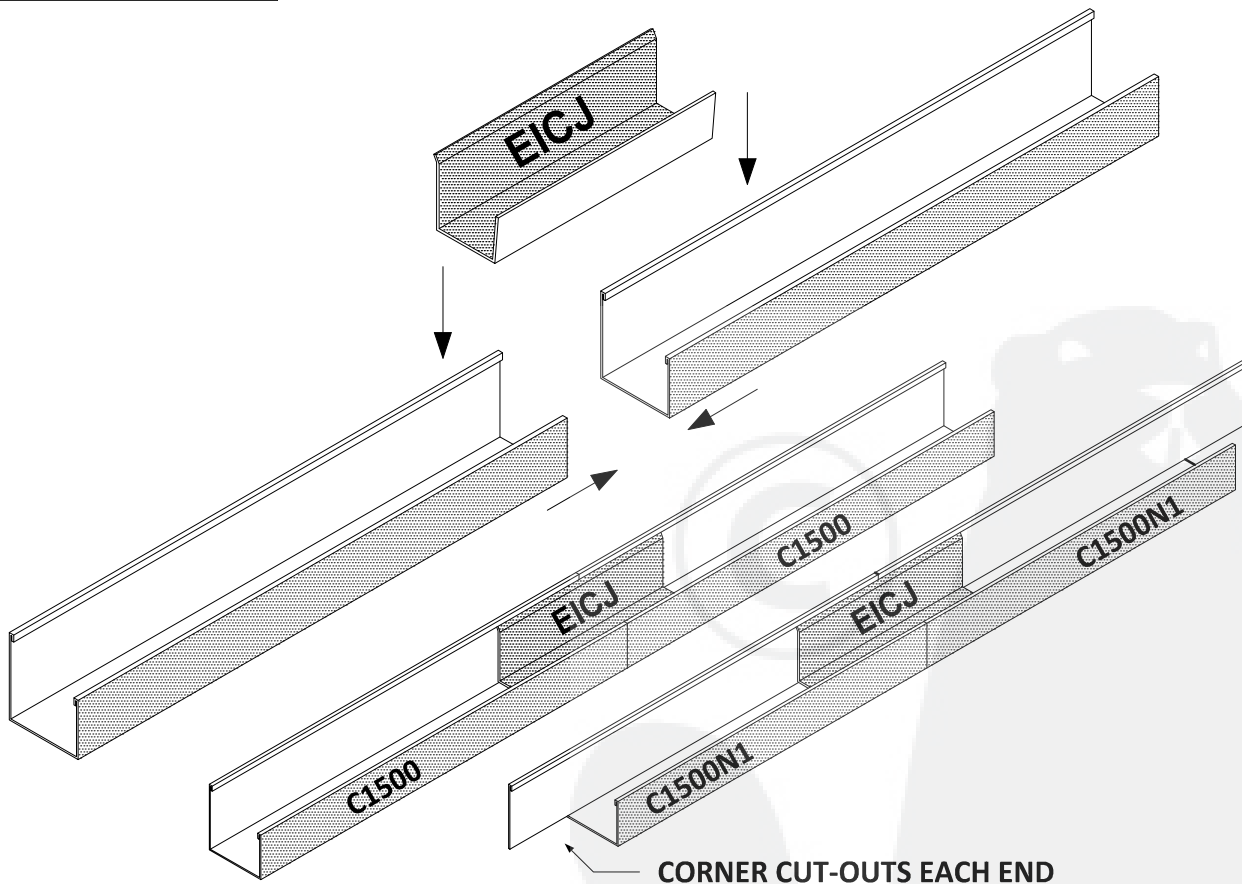

QTY	PART No.	LENGTH	NEW DETAILS
4	C1500	1500mm	= 2 @ 3000mm
8	C1500N1	1500mm	= 4 @ 3000mm

TEMPORARY & PERMANENT ANCHORING

PLEASE NOTE:

It is essential to firmly anchor your EnduraShed immediately following installation, otherwise there is a risk of damage to panels, property or persons resulting from sudden wind gusts. Select a level site and proceed as follows:

Method A Garden sheds may be anchored to the ground and a concrete slab poured inside. Steel surfaces should be protected from direct wet concrete (which has a corrosive action) by taping a 200mm wide strip of plastic up the wall and laying it out from the wall by 500mm.

Method B Garden sheds may be anchored to an approved existing concrete slab using the concrete fixing set (anchor brackets and bolts purchased separately)

Method C A rebated concrete slab as shown below will prevent water entry under the walls of the shed.

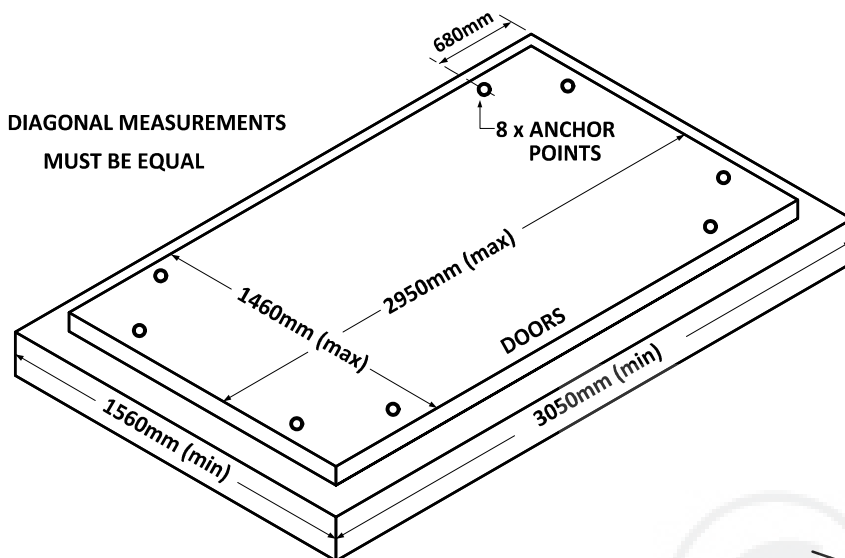

METHOD 'D'

Drive galvanized anchor pegs into the ground with the hook fastened over the bottom channel for short term temporary anchoring.

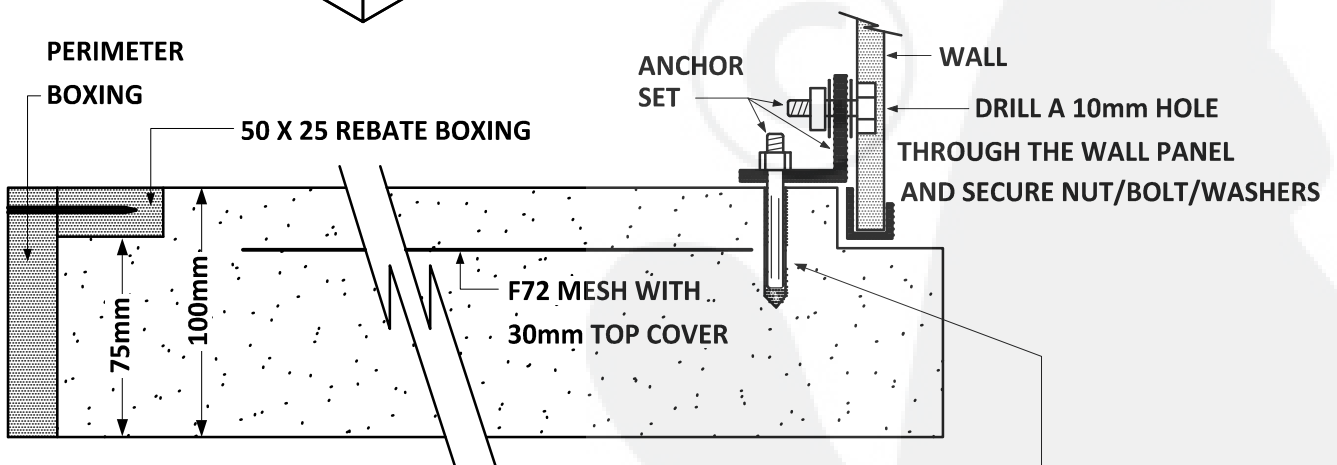

Using a 10mm diameter masonry drill, position the bracket and drill a 60mm deep anchor hole in the concrete. Insert the masonry anchor through the bracket into the anchor hole until the anchor nut is firmly seated against the bracket. Tighten the anchor nut with a spanner to attain maximum strength.

STEP 1. BACK PANEL ASSEMBLY

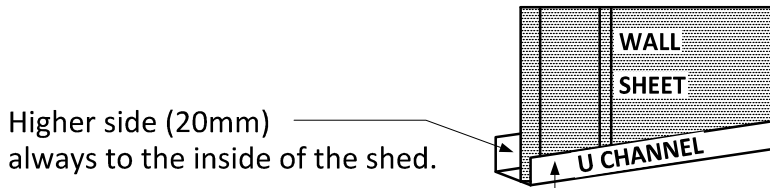

Higher side (20mm)
always to the inside of the shed.

Lower side (17mm)
always to the outside of the shed.

1.1 Lay out all the components
as shown below.

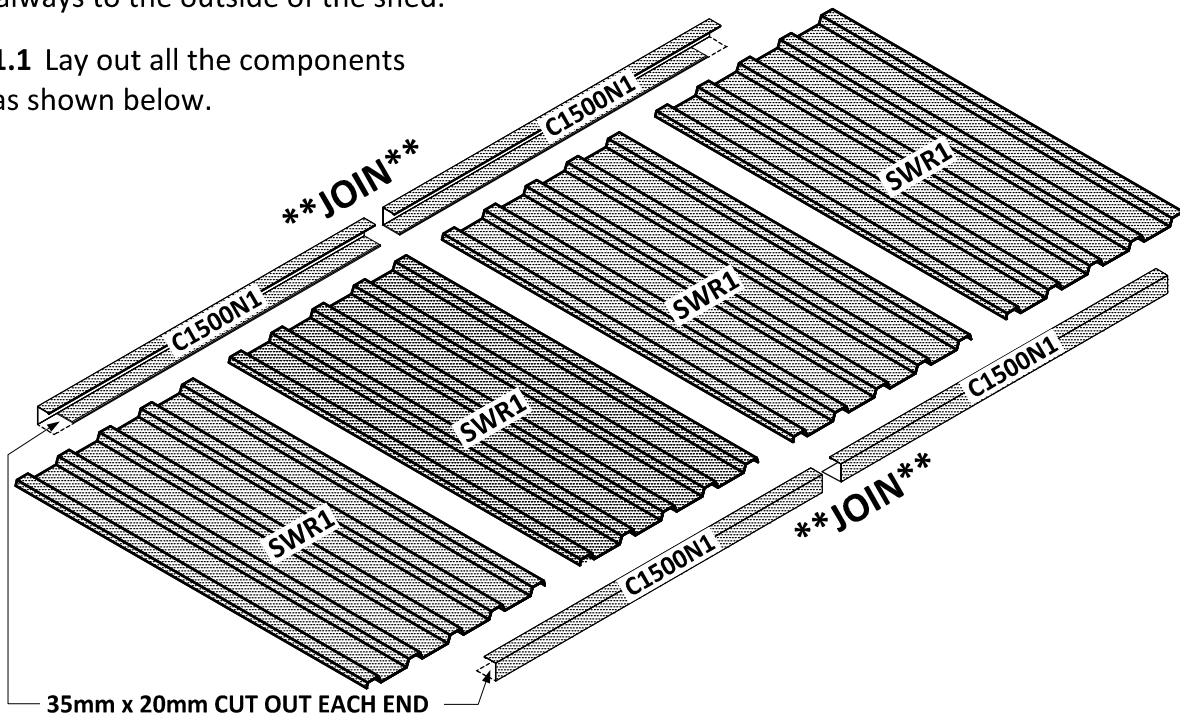

1.2 Overlap and fasten the four sheets together.
Move the U channels 'C1500N1' in position with the
ends butted together to form lengths of 3000mm,
then join the U channels together with the channel
joiners 'EICJ'. Fasten the channel joiners and the
U channels to the sheet in one operation as shown.

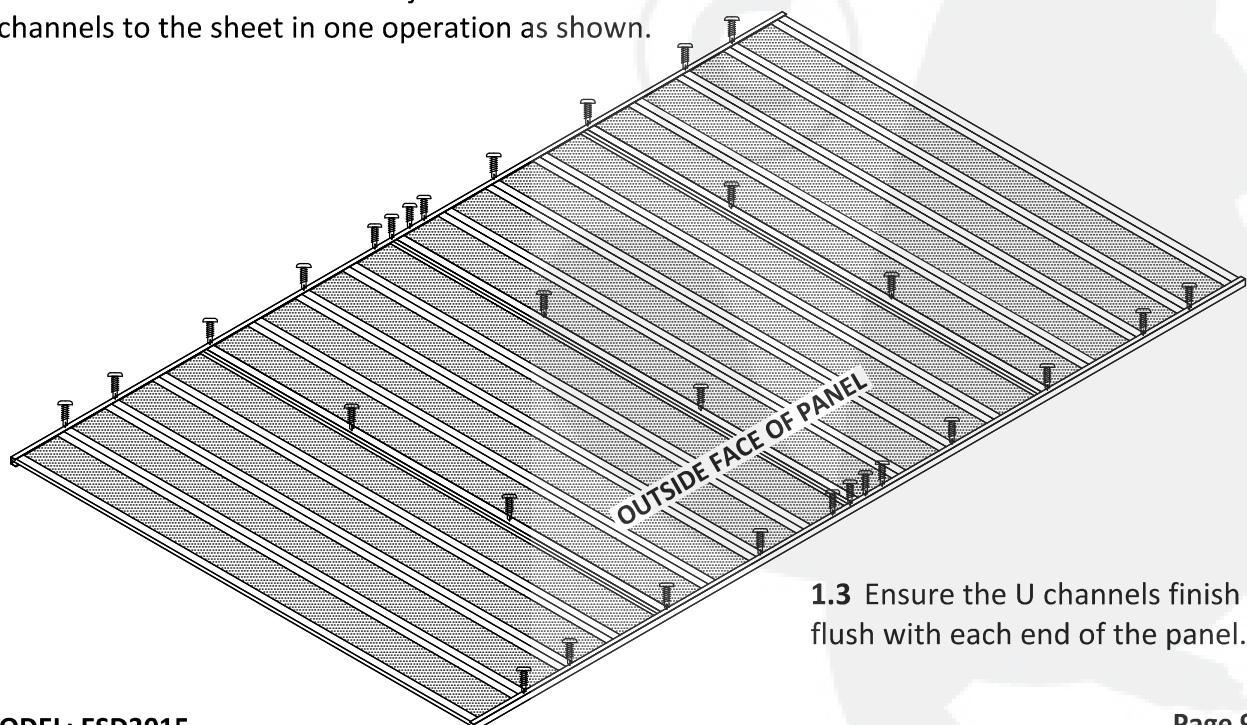

1.3 Ensure the U channels finish
flush with each end of the panel.

STEP 2. SIDE WALL ASSEMBLY (X 2)

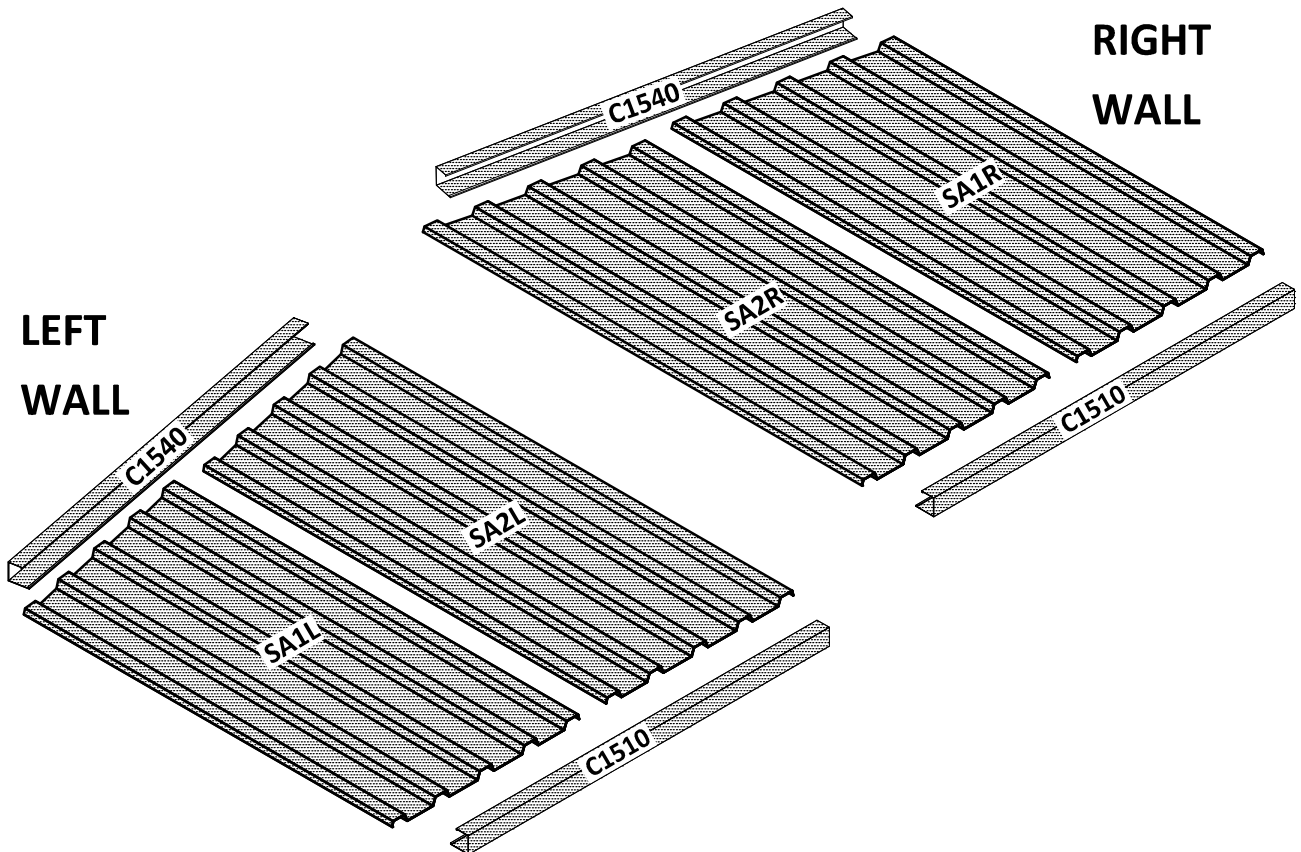

2.1 Overlap and fasten the sheets together, then position and fasten the two U channels to the ribs of the sheet as shown.

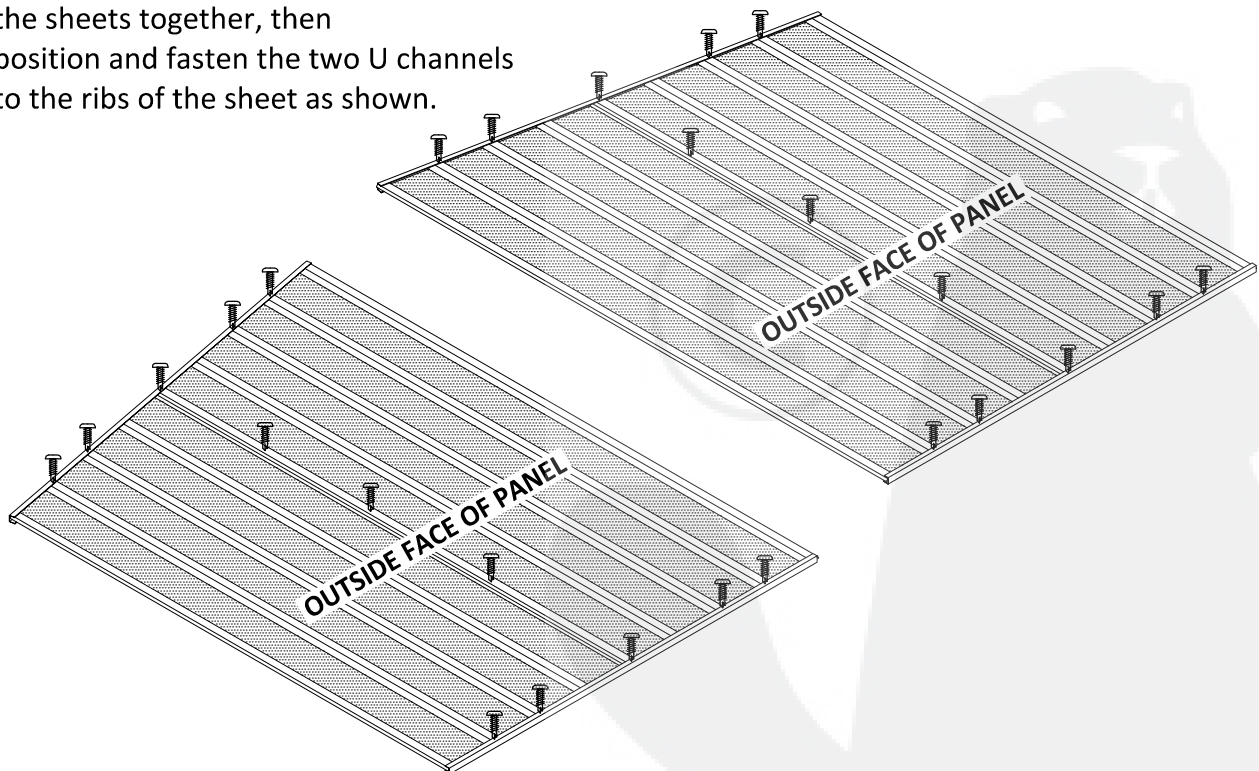

2.2 Ensure the U channels finish flush with each end of the panel.

STEP 3. ROOF PANEL ASSEMBLY

3.1 Lay out all the components as shown below.

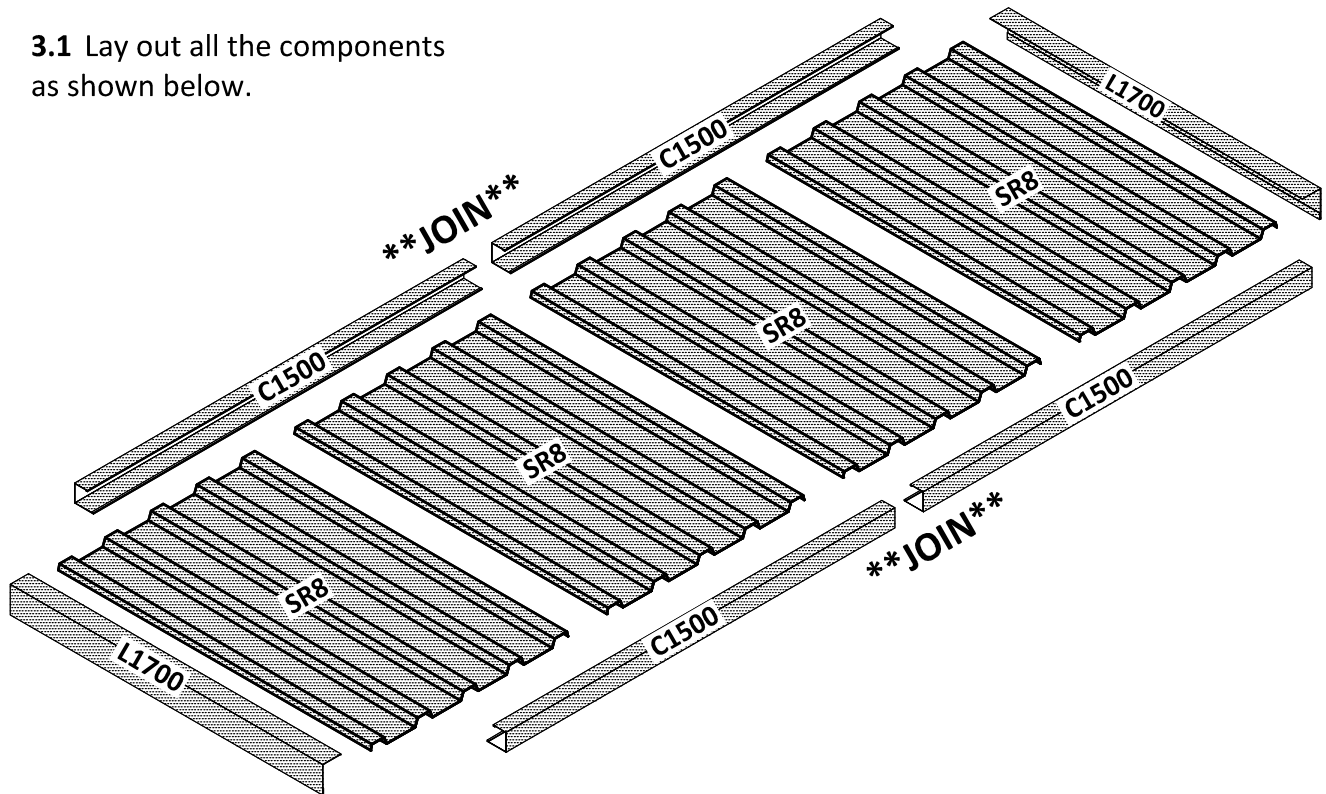

3.2 Overlap and fasten the four sheets together. Move the U channels 'C1500' in position with the ends butted together to form lengths of 3000mm, then join the U channels together with the channel joiners 'EICJ'. Fasten the channel joiners and the U channels to the sheet in one operation as shown.

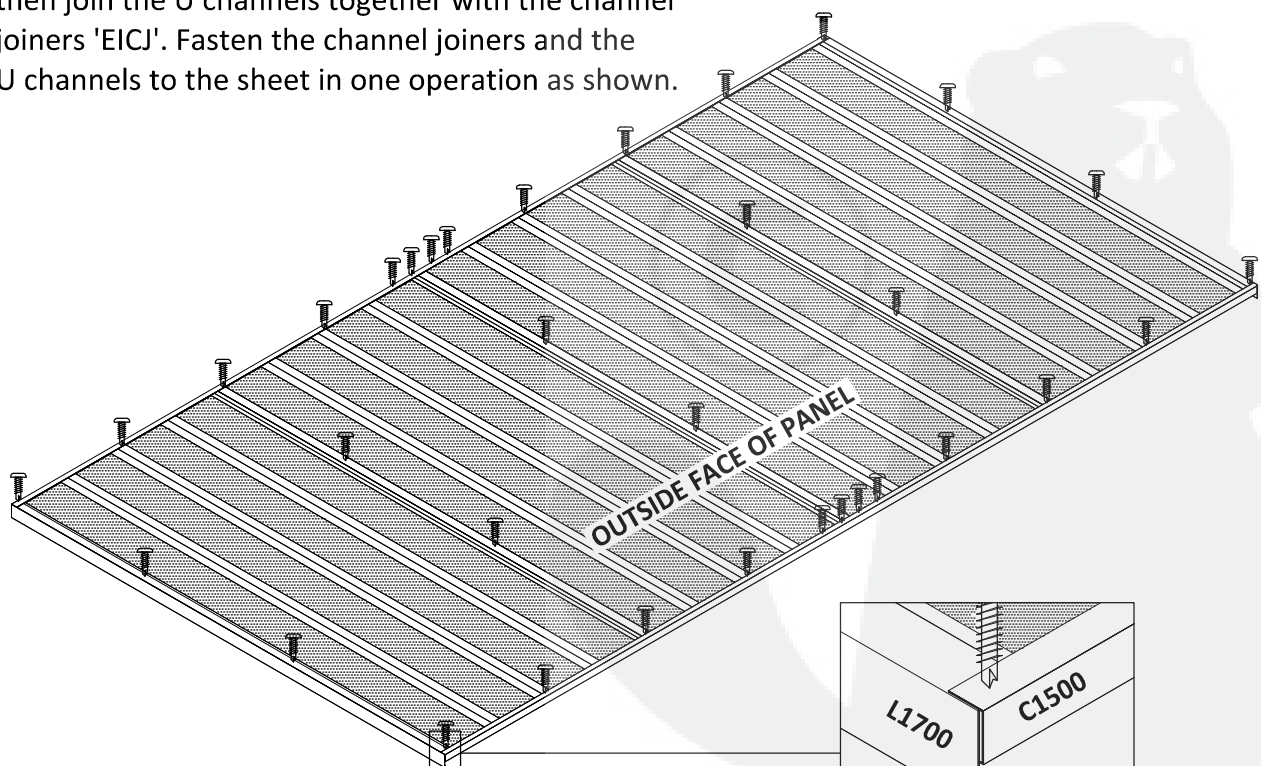

3.3 Position and fasten the two L flashings. The L flashing fits between the U channel and the outside face of the sheet.

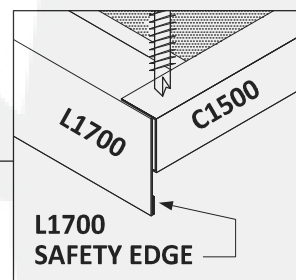

STEP 4. DOOR ASSEMBLY

PLEASE NOTE: It is very important that you take extra care when assembling the doors, to ensure that when hung, they align evenly with each other and open and close correctly.

As you fasten the vertical U channels and jamb, continually check that they are butted up to the edges of the door sheet, and follow the vertical sheet rib lines.

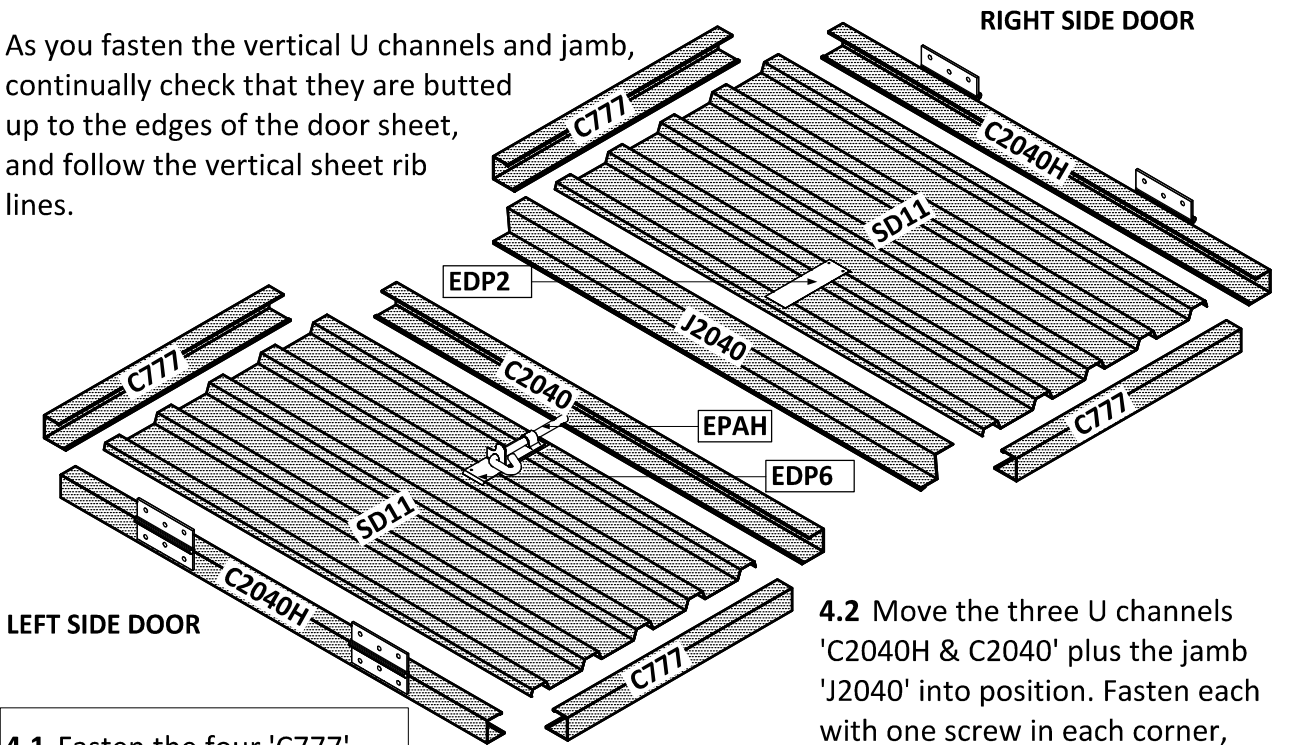

4.1 Fasten the four 'C777' U channels with two screws only at this stage, and ensure the U channels finish flush with the corners of the door sheet.

4.2 Move the three U channels 'C2040H & C2040' plus the jamb 'J2040' into position. Fasten each with one screw in each corner, screwing into the 'C777' U channels.

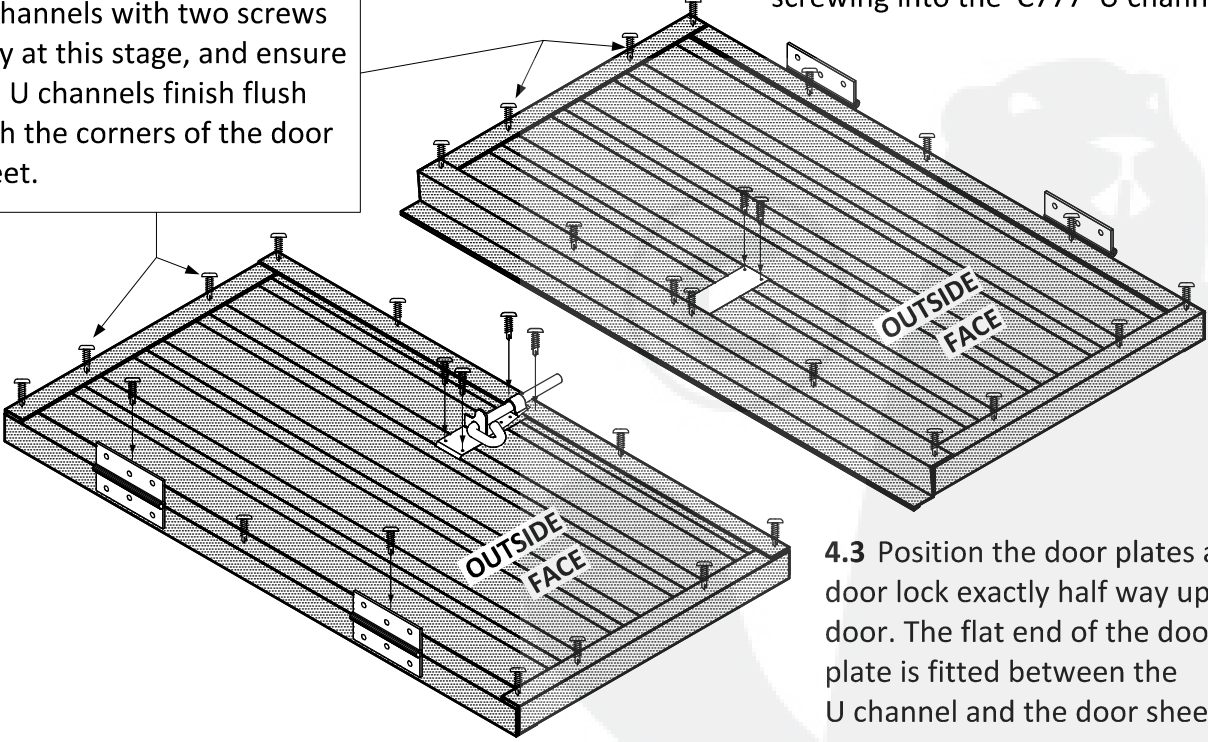

4.3 Position the door plates and door lock exactly half way up the door. The flat end of the door plate is fitted between the U channel and the door sheet.

4.4 Check that all the U channels are located correctly, and are parallel with each other, then continue to fasten all the components together as shown above.

STEP 5. FRONT PANEL ASSEMBLY

5.1 Layout all the components below and assemble them together without screws at this stage.

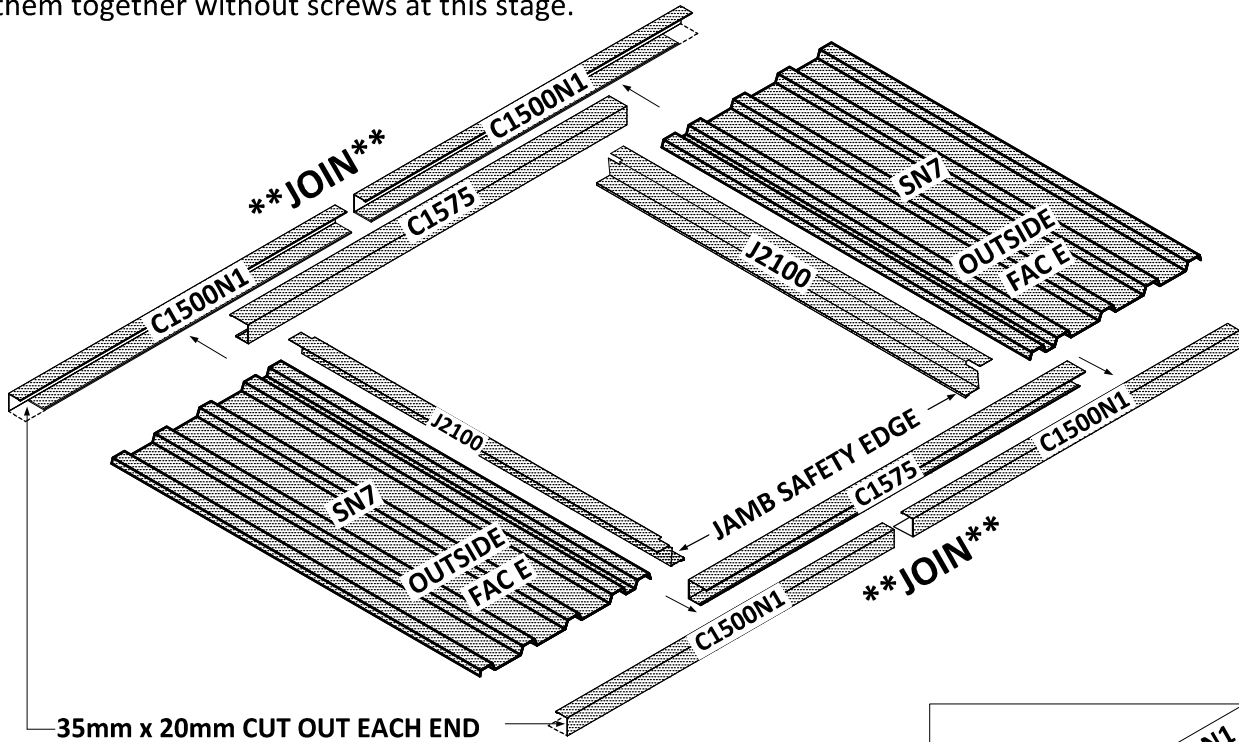

5.2 Fasten the U channels 'C1500N1' to the two sheets with one screw to the second rib in at each of the four corners.

5.3 Fasten the two U channels 'C1575' and the channel joiners 'EICJ' exactly in the centre of the two 'C1500N1' U channels leaving 712mm clear at each end.

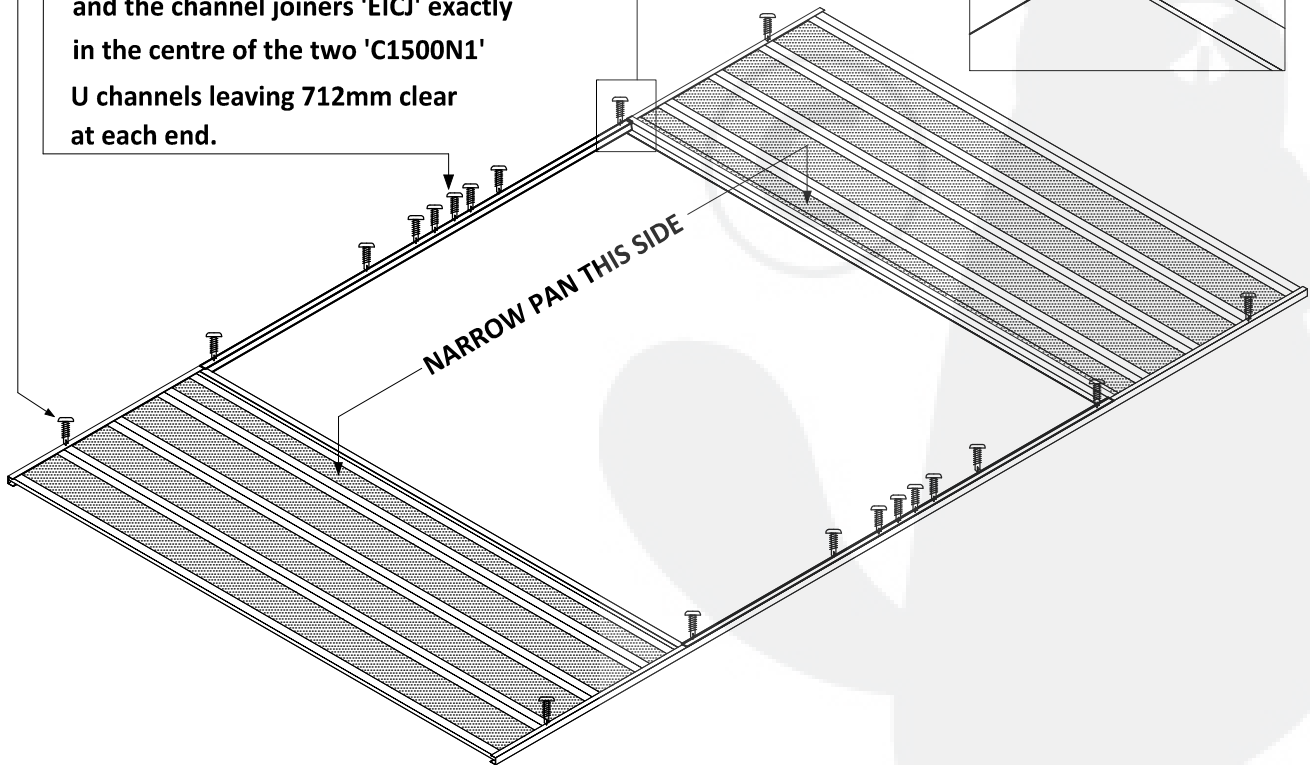
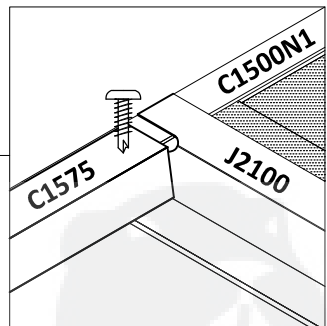

STEP 5. FRONT PANEL ASSEMBLY (CONT'D)

5.4 Before fastening the remainder of the panel together, double check that the door opening is correct by laying the doors in position. The width of the door opening must be exactly the same at the top and bottom.

5.5 After fastening all the components together, turn each door over and secure the hinges to each door jamb, with each door finishing 30mm from the top and bottom of the panel.

5.6 Fit the two internal door locks as shown below, so the shaft overhangs the door by 50mm, then fit the hasps to the the inside face of the C1500N1 U channels.

5.7 Fit the four door braces 'J1125' diagonally to the inside face of the doors.

The door braces should meet at the centre of the door and tuck neatly under the door U channel as shown. Fasten through each door brace into the sheet, remove the screws and re-fasten the screws from the outside face of the door.

INSTALLATION

(Two persons required to handle and fasten panels together)

Do not attempt to construct the shed during windy conditions.

Sudden wind gusts may damage the panels or cause personal injury.

Step 1. Layout the four wall panels as shown with the ribs facing down.

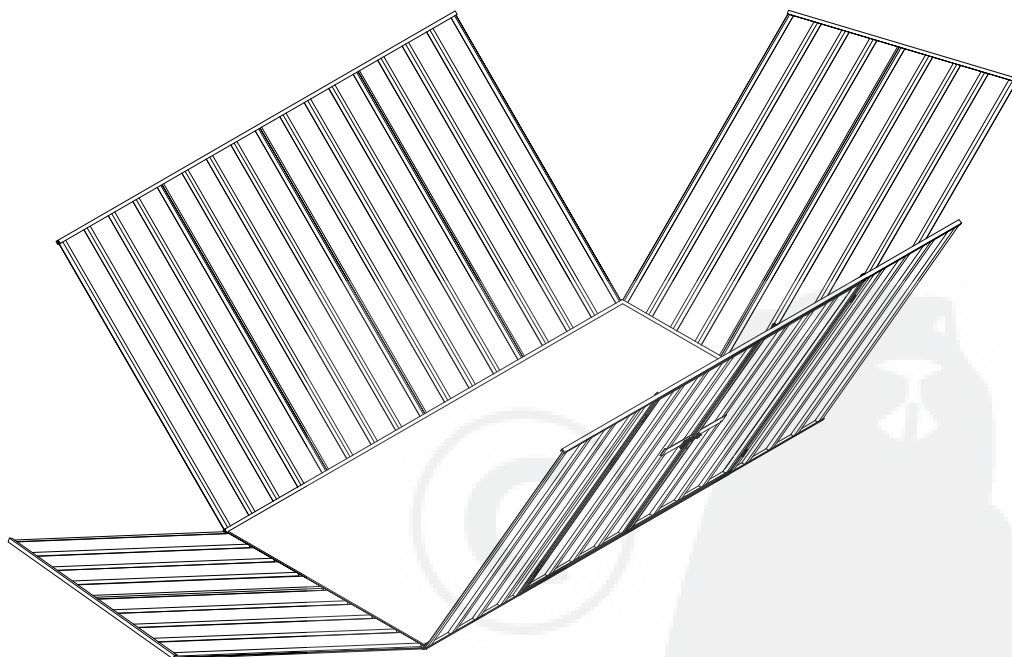
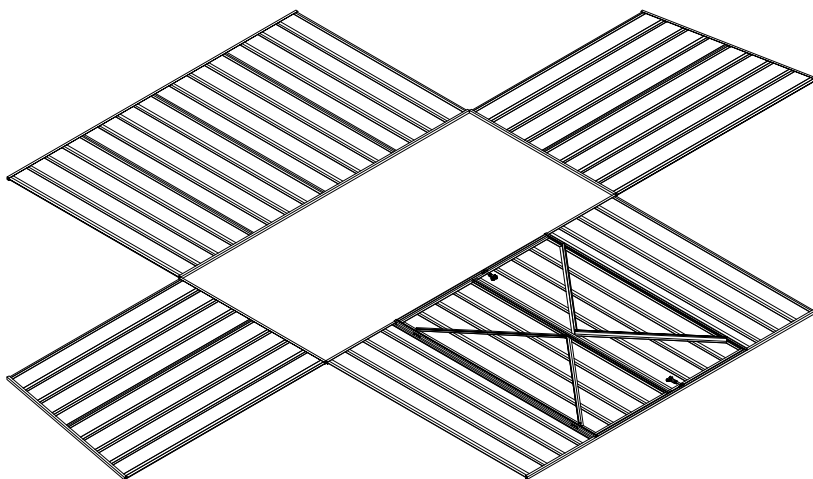

Step 2. Raise the panels in sequence as shown. The side panels will rest in the cut-out section of the front and rear U channels. Working from outside the shed, fasten the screws through the corner rib overlap.

Alternatively, pre-drill 3mm holes for the screws or use 3mm pop rivets if desired. Working from top to bottom, fasten the corner rib overlap 30mm from the top & bottom, then equally space three more screws about 440mm apart.



INSTALLATION - (CONT'D)

Step 3. Square up the four walls making sure that both diagonal measurements at the base are equal. Using chalk or a pen, mark the four corner locations on the concrete, as the walls may move during Step 4.

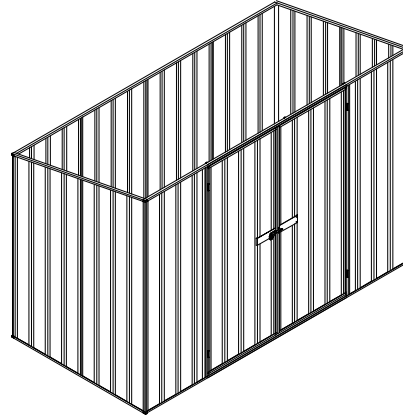

Step 4. Slide the roof panel into position and adjust the overhang to suit whilst maintaining a minimum rear or front overhang of 50mm. Secure through the L flashings and roof sheets with screws as shown.

**WARNING: NON-TRAFFICABLE ROOF
DO NOT CLIMB ON THE ROOF**

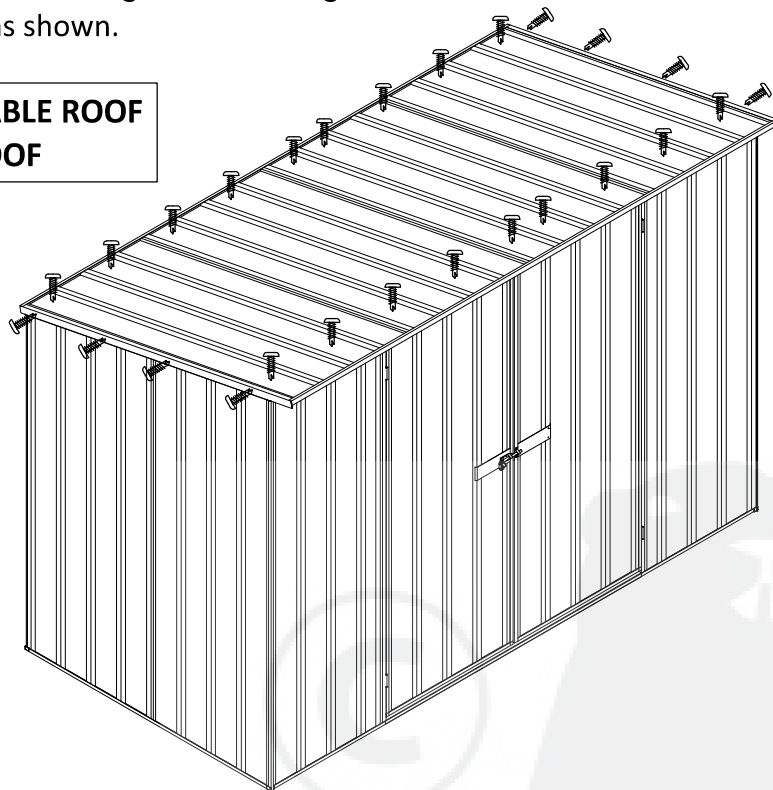

Step 5. Secure the shed to the concrete in accordance with the recommendations on page 8. If the site or concrete slab is not quite level, as often happens, the door may not align with the jambs properly. This may be adjusted by levering under the wall and packing beneath it, either directly below the bolt or below the hinges. A trial will soon show which is required. This adjustment should be made before anchoring the shed.

Warning: The Manufacturer accepts no responsibility for damage to person or property resulting from the inadequate anchoring of the shed, whether installed by the manufacturer, their agents or by another person.

2017 EXPORT PRODUCT WARRANTY

We warrant that the steel panels used in EnduraShed products will not rust or corrode for 20 years from date of exportation from Australia.

This warranty applies to EnduraShed products assembled in accordance with the manufacturer's assembly instructions, and utilised for normal domestic use, and is not transferable.

This warranty does not apply to EnduraShed products located within ten kilometres of any coastline.

This warranty does not cover damage to any EnduraShed products or stored contents as a result of extreme weather conditions including wind, rain, storms, floods, snow or ice.

All warranty claims are limited to the delivery and replacement of steel panels only. Any warranty claim will require a time frame of three months for the execution of delivery by normal sea-freight transportation mode.

Please direct any warranty claim enquiry to your point of purchase.

Please direct any other enquiry to: inquiries@endurashed.com

SNOW WARNING:

Your EnduraShed product may not support the weight of snow and ice. It is your responsibility to sweep the snow off the roof regularly. During heavy snowfalls, do not open the door(s) until all the snow has been removed from the roof.

MAINTENANCE GUIDELINES:

To maintain the protective steel coating and maximise the lifespan of your EnduraShed product, wash it clean twice yearly with soapy water and hose off, in coastal or industrial areas, this should be implemented on a more regular basis.

Extreme weather conditions, typically heavy driving rain, may allow some rainwater entry between some of the garden components. It is important to regularly check the fastening points of your garden shed to ensure that all components are tightly secured together.

Do not backfill dirt or garden mix against the steel walls as this will rapidly corrode the garden shed components and void your warranty. Store all lawn, garden and other fertilisers and chemicals at least 300mm (12") away from the wall panels as these products can also rapidly corrode the garden shed components.

The manufacturer accepts no responsibility for damage to your EnduraShed product or contents arising from any of the above recommendations and maintenance guidelines.

