

RASENTRAKTOREN
LAWN TRACTORS
Tracteurs de pelouse

Inhaltsverzeichnis
Table of contents
Tables de matières





Modelle 2007

Crossover

74 / 13

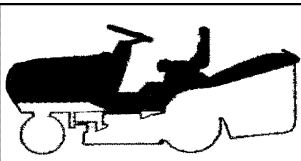
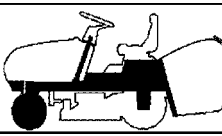
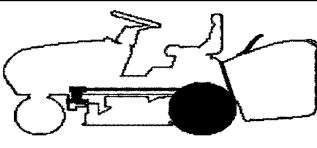
Art. 65053

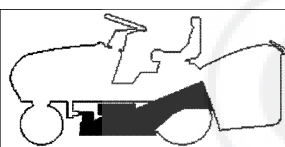
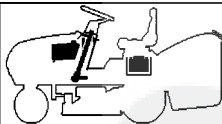
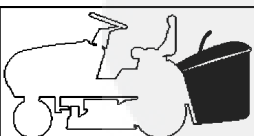
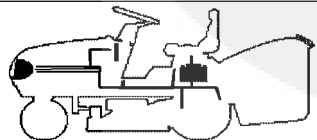
1		KARROSSERIE BODY CARROSSERIE
2		RAHMENSATZ & LENKGETRIEBE CHASSIS & STEERING CHASSIS & BARRE DE DIRECTION
3		GETRIEBE TRANSMISSION TRANSMISSION
4		MOTOR ENGINE MOTEUR
5		SCHNEIDWERK CUTTING PLATE PLATEAU DE COUPE
6		TANK, BATTERIE & KOMPONENTEN TANK, BATTERY & COMPONENTS TANK, BATTERIE & COMPOSANTS
7		GRASFANGSACK KPL. GRASS CATCHER ASSY. BAC COMPOSANTS
8		ELEKTRIK 1 ELECTRIC 1 ELECTRIQUES 1



KARROSSERIE
BODY
CARROSSERIE

Crossover

74 / 13

Art. 65053

2007

1-7

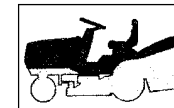

KARROSSERIE
BODY
CARROSSERIE



Geräte für Haus und Garten

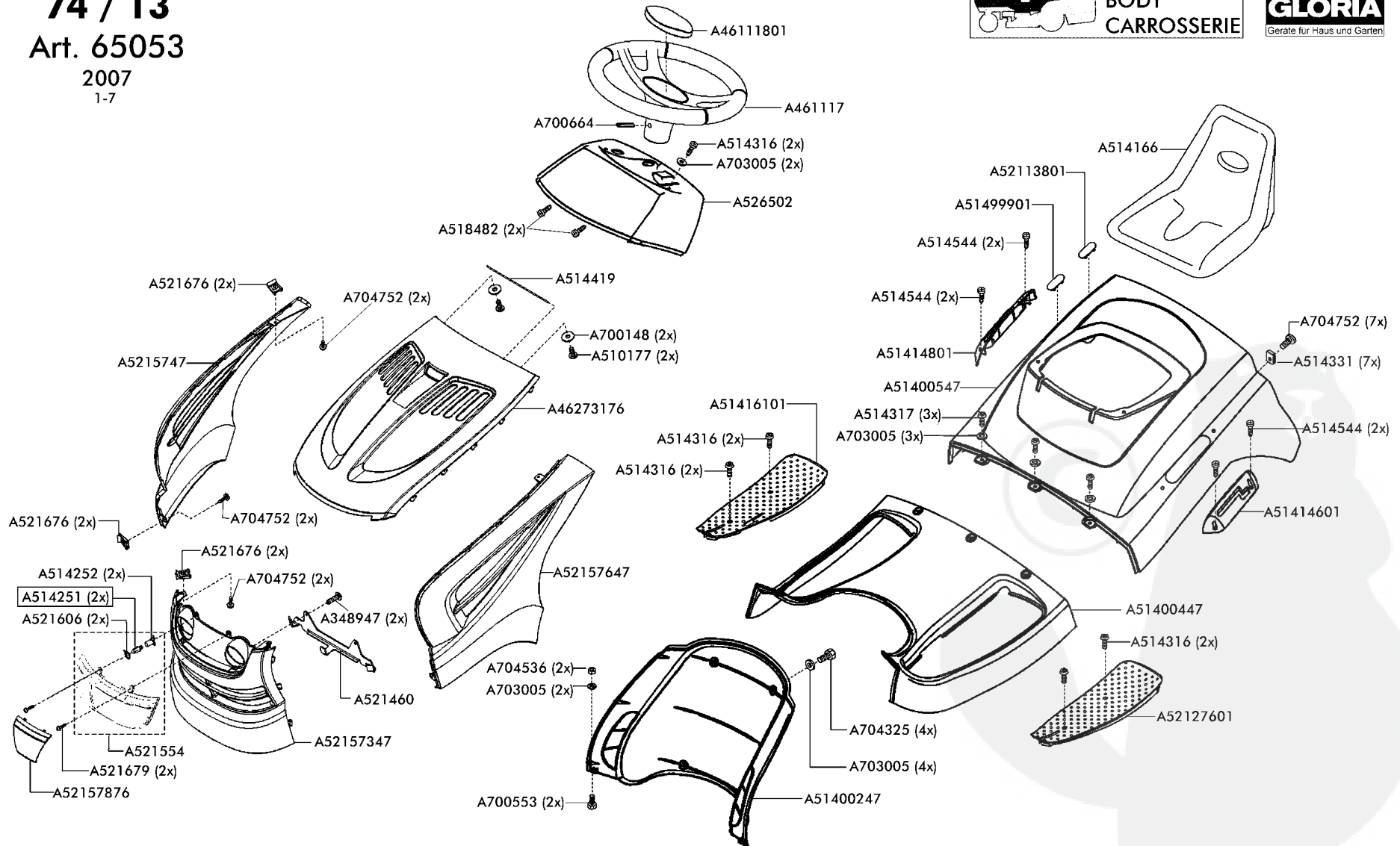

Technische Änderungen vorbehalten

2/22		RASENTRAKTOREN		Crossover	
2007		LAWN TRACTORS		74 / 13 - Art. 65053	
Rev073703		Tracteurs de pelouse		Modell 2007	
Bild Nr. REF.N° POS.N°		BEST.-NR. PART-N°. N° d. PIECE		BEZEICHNUNG	
				DESCRIPTION	
				DÉSIGNATION	
				Qty.	
1	A348947	SHR PT-KB 60X20 1442	Screw	VIS	2
2	A461117	LENKRAD KPL	STEERING WHEEL	VOLANT	1
3	A46111801	ABDECKKAPPE FÜR LENKRAD R9005	CAP	BOUCHON	1
4	A46273176	OBERTEIL HAUBE BRILL R7016	ENGINE HOOD GREEN	CAPOT	1
5	A510177	SHR PT-KB 60 X14 1411	Screw	VIS	2
6	A51400247	KONSOLE MOTORHAUBE R6001	DASHBOARD	TABLEAU DE BORD	1
7	A51400447	MITTELKONSOLE VORNE R6001	FRONT CENTRAL DASHBOARD	SUPPORT TABLEAU CENTR.	1
8	A51400547	MITTELKONSOLE HINTEN R6001	MIDDLE DASHBOARD	TABLEAU CENTR.	1
9	A51414601	ABDECKUNG 74-13 R9005	COVER 74-13	CAPOT 74-13	1
10	A51414801	ABDECKUNG SCHALTGETRIEBE R9005	COVER	CAPOT	1
11	A51416101	TRITTPLATTE RECHTS R9005	RIGHT FOOTBOARD	MARCHEPIED DROITE	1
12	A514166	SITZ SEAT 1	SEAT	SIEGE	1
13	A514251	LAMPE XENON 6W	FARILAMP FOR LIGHTS	LAMPE POUR PHARES	2
14	A514252	LAMPENFASSUNG TRAKTOR	LAMP HOLDER	DOUILLE DE LAMPE	2
15	A514316	SCHRAUBE SFS-TAPT 6X12 2019 A3R	SCREW	VIS	2
16	A514317	SCHR.SFS.TAPT6X16 2019 A3R	Screw	VIS	3
17	A514326	PASSFEDER 1/4"X1/4"X1 3/4	Key	CLAVETTE	6
18	A514331	BLECHMUTTER 4.8 FORM 1 VZ	Hex.Nut	ECROU	7
19	A514419	FEDERSTAHLDRAHT VERZ	SPRING WIRE	BARRE	1
20	A514544	SCHR.PT-KB60X30 1411A3R	Screw	VIS	4
21	A51499901	ABDECKKAPPE MITTELKONSOLE R9005	COVER PLATE	COUVRE	1
22	A518482	SCHR.PT-KB50X18 1411	Screw	VIS	2
23	A52113801	ABDECKKAPPE MITTELKONSOLE R9005	COVER	COUVRE	1
24	A52127601	TRITTPLATTE LINKS R9005	LEFT FOOTBOARD	MARCHEPIED GAUCHE	1
25	A521460	SCHARNIERBLECH HAUBE	CLAMP SUPPORT	ETRIER SUPPORT	1
26	A521554	SCHEINWERFER KPL HAUBE-4 XENON 6W	GRILL	PANNEAU	1
27	A52157347	FRONTTEIL HAUBE R6001	Front cover	FRONT	1
28	A52157547	SEITENTEIL RECHTS HAUBE R6001	Side cover right	CAPOT DROITE	1
29	A52157647	SEITENTEIL LINKS HAUBE R6001	Side cover left	CAPOT GAUCHE	1
30	A52157876	ABDECKUNG VORNE	Front hood	CAPOT A L'AVANT	1
31	A521606	SCHLAUCHKLEMME "REFLEKTOR"	Fastener	BORNE	2
32	A521676	SCHNAPPMUTTER NU 0921	Nut	ECROU	6
33	A521679	SCHR PT-KB 30X12 WN 5452	Screw	VIS	2
34	A526502	BEDIENKONSOLE TAMP Y-SILBER	DASHBOARD	TABLEAU DE BORD	1
35	A700148	SHB 6,4 9021-ST VZ	Washer	RONDELLE	2
36	A700553	SHR 6X 40 933- 8.8VZ	Screw	VIS	2
37	A700664	HUEL SPAN 8 X 60 1481	BUSH	DOUILLE	1
38	A703005	SHB A6.4 A3S 9021ers.d.703005	Washer	RONDELLE	11
39	A704325	SHR 6X 40 933- 8.8A3S	Screw	VIS	4
40	A704536	MU 6KT 6 985- 8 A3B	Hex.Nut	ECROU	2
41	A704752	SHR KO 4,8X16 ZZ-C7981VZ	Screw	VIS	11

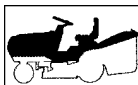

KARROSSERIE
BODY
CARROSSERIE

BRILL

GLORIA
Gloria 121 Power and Control

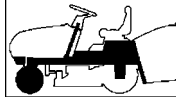



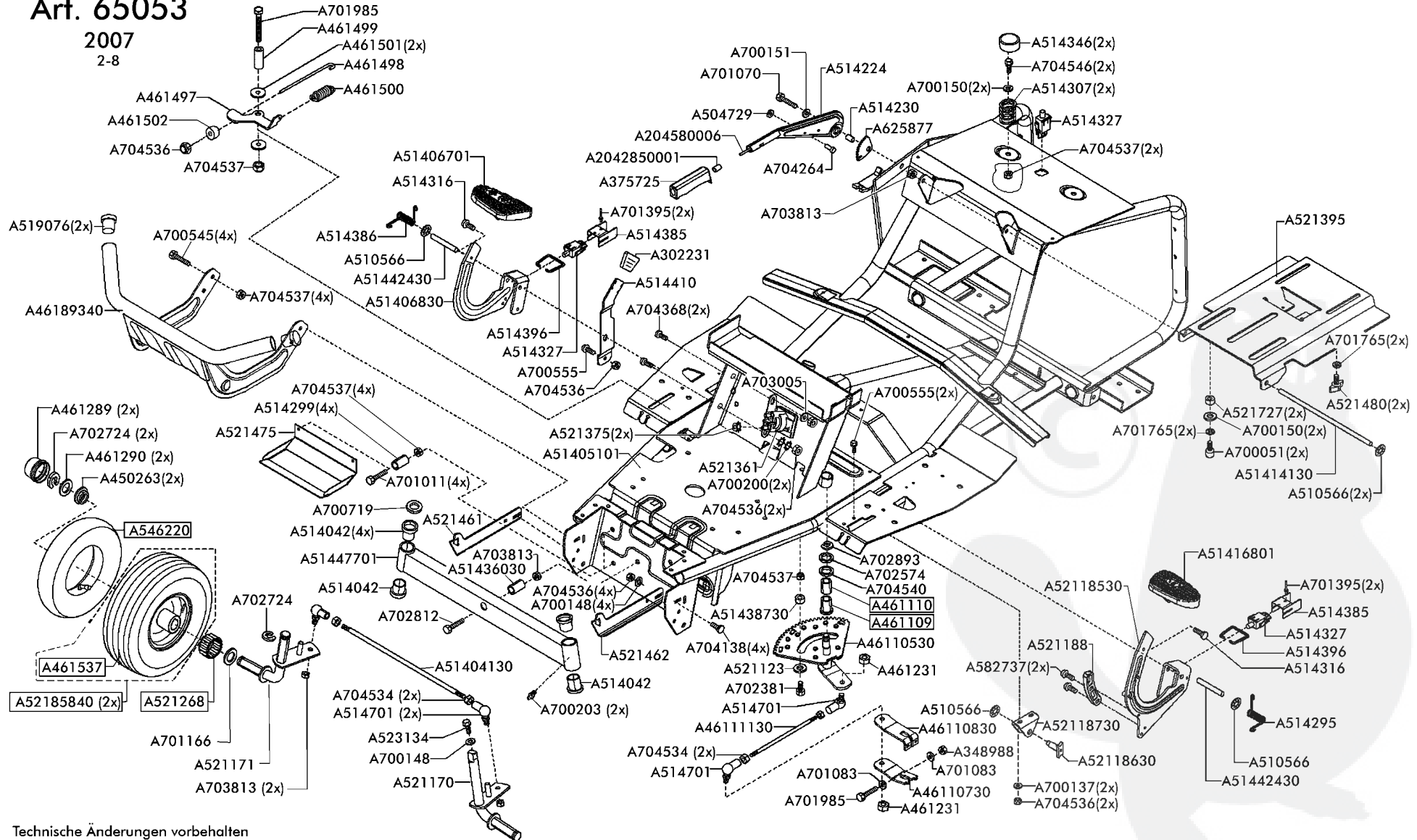
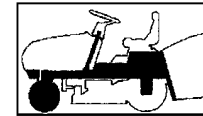

Crossover 74 / 13 Art. 65053

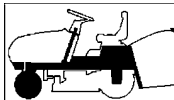

2007
2-8



Technische Änderungen vorbehalten

4/22		RASENTRAKTOREN		 RAHMENSATZ & LENKGETRIEBE CHASSIS & STEERING CHASSIS & BARRE DE DIRECTION		Crossover		74 / 13 - Art. 65053 Modell 2007		 	
2007		LAWN TRACTORS				Rev073703				Tracteurs de pelouse	
Bild Nr. REF.N° POS.N°	BEST.-NR. PART.-N° N° d. PIECE	BEZEICHNUNG	DESCRIPTION	DÉSIGNATION	Qty.						
1	A2042850001	DRUCKKNOPF F. BR-HEBEL T	PRESSURE KNOP	BOUTON DE PRESSION	1						
2	A2045480006	FEDER F. HANDGRIFF T	SPRING RIGHT	RESSORT DROITE	1						
3	A302231	KAPPE R9005	COVER	COUVRE	1						
4	A348988	MUTTER SIC- BIW M 8 A3C- 8 MITTELGESICH	NUT	ECROU	1						
5	A375725	HANDGRIFF HOENENVERST. T	HANDLE	POIGNEE	1						
6	A450263	BUCHSE TRAKTOR VORDERRAD	BRASS	COUSSINET	2						
7	A46110530	LENKSEGMENT GESCHW VERZ	SEGMENT	SEGMENT GUIDER	1						
8	A46110730	LENKHEBEL 2 TEILIG UNTEN VERZ	LOWER STEERING ARM	LEVIER GUIDER EN BAS	1						
9	A46110830	LENKHEBEL 2 TEILIG OBEN VERZ	UPPER STEERING ARM	LEVIER GUIDER EN HAUT	1						
10	A461109	BUNDBUCHSE LENKUNG	COLLAR BUSH	DOUILLE	1						
11	A461110	BUCHSE	BUSH	DOILLE	1						
12	A46111130	SCHUBSTANGE VERZ	STEERING ROD	BARRE DE DIRECTION	1						
13	A461231	MUTTER SIC- BIW M10 A3B- 8	NUT	ECROU	2						
14	A461289	ABDECKKAPPE"TRAKTOR"	HUB COVER	COUVRE MOYEU	2						
15	A461290	SCHEIBE 42MM FÜR TRAKTOR	WASHER	RONDELLE	2						
16	A461497	WIPPE FÜR KUPPLUNG FAHRANTRIEB	SUPPORT	SUPPORT	1						
17	A461498	ZUGSTANGE FÜR KUPPLUNG FAHRANTRIEB	TENSION ROD	BARRE	1						
18	A461499	ROHR FÜR KUPPLUNG FAHRANTRIEB	TUBE	TUBE	1						
19	A461500	ZUGFEDER FÜR KUPPLUNG FAHRANTRIEB	TENSION SPRING	RESSORT DE TRACTION	1						
20	A461501	LAGERSCHEIBE FÜR KUPPLUNG FAHRANTRIEB	DISC	RONDELLE	2						
21	A461502	KUGELFÜHRUNG FÜR KUPPLUNG FAHRANTR	GUIDE	GUIDE	1						
22	A461537	MANTEL FÜR REIFEN 13X6,00-6 2PR	TIRE 13X6,00-6 2PR	PNEU 13X6,00-6 2PR	2						
23	A46189340	STOSSSTANGE 30 MM LANG GESC R9006 BRILL	PUSH ROD	PAE-CHOCS	1						
24	A504729	SCHNELLBEFESTIGER 5SXN26	STARLOCK	STARLOCK	1						
25	A510566	SCHNELLBEFESTIGER 8SXN26	CROWN FASTENER	FIXATEUR A COURONNE	5						
26	A51404130	SPURSTANGE VERZ	STEERING ROD	BARRE DE DIRECTION	1						
27	A514042	BUCHSE-ACHSSCHENKEL	BUSH	DOUILLE	4						
28	A51405101	RAHMEN GESCHWEISST R9005	CHASSIS	CHASSIS	1						
29	A51406701	PEDALAUFLAGE BREMSE UND KUPPL. R9005	SUPPORT	SUPPORT	1						
30	A51406830	PEDAL RECHTS VERZ	PEDAL RIGHT	PEDAL DROITE	1						
31	A51414130	LAGERSTANGE SITZKONSOLE VERZ	ROD	BARRE	1						
32	A51416801	PEDALAUFLAGE MÄHANTRIEB R9005	SUPPORT	SUPPORT	1						
33	A514224	HEBEL KPL.HÖHENVERSTELLUNG	LEVER CPL	LEVIER CPL	1						
34	A514230	HÜLSE	BUSH	DOUILLE	1						
35	A514295	DREHFEDER LINKS	TORSION SPRING LEFT	TORSSION DE RESSORT GAUCHE	1						
36	A514299	PENDELANSCHLAG	BLOCK	BUTEE	4						
37	A514307	DRUCKFEDER FÜR SITZ	PRESSURE SPRING	RESSORT A PRESSION	2						
38	A514316	SCHRAUBE SFS-TAPT 6X12 2019 A3R	SCREW	VIS	2						

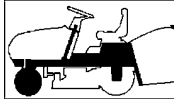
5/22		RASENTRAKTOREN		 RAHMENSATZ & LENKGETRIEBE CHASSIS & STEERING CHASSIS & BARRE DE DIRECTION	Crossover		 
2007		LAWN TRACTORS			74 / 13 - Art. 65053		
Rev073703		Tracteurs de pelouse			Modell 2007		
Bild Nr. REF.N° POS.N°	BEST.-NR. PART-N° N° d. PIECE	BEZEICHNUNG	DESCRIPTION	DÉSIGNATION	Qty.		
39	A514327	DRUCKSCHALTER	PRESS SWITCH	INTERRUPTEUR À PRESSION	2		
40	A514346	ABDECKKAPPE D-35 RAL9005	COVER	COUVRE	2		
41	A51436030	LAGERBUCHSE-VORDERACHSE VERZ	BRASS	COUSSINET	1		
42	A514385	SCHALTERHALTER	SWITCH SUPPORT	SUPPORT INTERRUPTEUR	2		
43	A514386	DREHFEDER RECHTS	TORSION SPRING RIGHT	TORSSION DE RESSORT DROITE	1		
44	A51438730	DISTANZBUCHSE VERZ	SPACER	ENTRETOISE	1		
45	A514396	BÜGEL	CONNECTING PLATE	PAQUE DE CONNEXION	1		
46	A514410	FESTSTELLFEDER RECHTS	SPRING RIGHT	RESSORT DROITE	1		
47	A51442430	LAGERBOLZEN PEDAL VERZ.	PIN	PIVOT	2		
48	A51447701	PENDELACHSE GESCHW R9005	FLOATING AXLE	ABRE OSCILLANT	1		
49	A514701	WINKELGELENK CS16-M10+SIC	JOINT	JOINT	4		
50	A519076	ROHRSTOPFEN FÜR ROHR 30X2	PLUG	BOUCHON	2		
51	A521123	SCHEIBE D50X5 NACHARBEIT	WASHER	RONDELLE	1		
52	A521170	ACHSSCHENKEL LI.VZ.NEU ET	LEFT STUB AXLE	FUSEAU GAUCHE	1		
53	A521171	ACHSSCHENKEL RE.VZ.NEU ET	RIGHT STUB AXLE	FUSEAU DROITE	1		
54	A52118530	FUSSHEBEL GESCHW VERZ	DRIVE PEDAL	PEDALE TRANSMISSION	1		
55	A52118630	FIXIERUNG VERZ.	PLATE	PLAQUE	1		
56	A52118730	LAGERBOCK VERZ	BEARING BRACKET	CHEVALET SUPPORT	1		
57	A521188	FÜHRUNG PKR 74/82	GUIDE	GUIDE	1		
58	A521268	ROLLENLAGER 20X30X55	ROLLER BEARING	BOITE D'ESSIEU A ROULEAUX	2		
59	A521361	STARTERRELAIS 12V/100AMPER	STARTER RELAY	RELAIS D'ALLUMAGE	1		
60	A521375	SKT-MU.+SPERRZ.1/4"-20 UN 8.8	NUT	ECROU	2		
61	A521395	VERSTELLKONSOLE SITZ GENIETET	FIXED SEAT SUPP.	SUPPORT SIEGE FIXE	1		
62	A521461	ANBINDUNGSBLECH RECHTS	STIFFENING RIGHT	RENFORCEMENT DROITE	1		
63	A521462	ANBINDUNGSBLECH LINKS	STIFFENING LEFT	RENFORCEMENT GAUCHE	1		
64	A521475	WÄRMELEITBLECH UNTEN H-4 UND 2 ZYLINDER	PLATE	PLATEAU	1		
65	A521480	FLÜGELSCHRAUBE M8X20	WING SCREW	VIS A AILETTES	2		
66	A521727	DISTANZBUCHSE	SPACER	ENTRETOISE	2		
67	A52185840	VORDERRAD 13X6.0-6 KPL R9006	FRONT WHEEL 13X6.0-6	ROUE AVANT 13X6.0-6	2		
68	A523134	SFS-TAPT.M6X12 2021 A2K	SCREW	VIS	1		
69	A546220	SCHLAUCH 13"X6.5"-6 TR13	TUBE	TUYAU	2		
70	A582737	SHR DUO-TAP 5X10-C ST A2K	SCREW	VIS	2		
71	A625877	SEGMENT "FE/ZN 12 F"	SEGMENT	SEGMENT	1		
72	A700051	SHR 8X 20 912- 8.8 VZ	SCREW	VIS	2		
73	A700137	SCHEIBE A 6,4 125-ST VZ	WASHER	RONDELLE	2		
74	A700148	SHB 6,4 9021-ST VZ	WASHER	RONDELLE	5		
75	A700150	SHB 8,4 9021-ST VZ	WASHER	RONDELLE	4		
76	A700151	SHB 10,5 9021-ST VZ	WASHER	RONDELLE	1		

6/22		RASENTRAKTOREN		 RAHMENSATZ & LENKGETRIEBE CHASSIS & STEERING CHASSIS & BARRE DE DIRECTION	Crossover		 
2007		LAWN TRACTORS			74 / 13 - Art. 65053		
Rev073703		Tracteurs de pelouse			Modell 2007		
Bild Nr. REF.N° POS.N°	BEST.-NR. PART-N° N° d. PIECE	BEZEICHNUNG	DESCRIPTION	DÉSIGNATION	Qty.		
77	A700200	SHB FÄCHER- J 6,4 6798 VZ	WASHER	RONDELLE	2		
78	A700203	NIPPEL AS 6X1 KEG 71412	NIPPLE AS 6X1 KEG 71412	RACCORD DE GRAISSAGE AS 6X1 KEG 71412	2		
79	A700545	SHR 8X 16 933- 8.8VZ	SCREW	VIS	4		
80	A700555	SHR 6X 16 933- 8.8VZ	SCREW	VIS	3		
81	A700719	SHB 21 433 VZ	WASHER	RONDELLE	1		
82	A701011	SHR 8X 50 933- 8.8VZ	SCREW	VIS	4		
83	A701070	SHR10X 40 933- 8.8VZ	SCREW	VIS	1		
84	A701083	SCHEIBE 8,4VZ7349"701083"	WASHER	RONDELLE	2		
85	A701166	SHB PA 20X28X0,5 988	WASHER	RONDELLE	2		
86	A701395	BLINDNIET 4,0X 8	RIVET	RIVET	4		
87	A701765	SHB FÄCHER- A 8,4 6798 VZ	WASHER	RONDELLE	4		
88	A701985	SCHRAUBE 8X 55 931- 8.8VZ	SCREW	VIS	2		
89	A702381	SHR 8X 30 7991- 8.8 VZ	SCREW	VIS	1		
90	A702574	SCHEIBE PA 14X20X1,0 988 VZ	WASHER	RONDELLE	1		
91	A702724	SHB SICH 15 6799 VZ	WASHER	RONDELLE	3		
92	A702812	SHR10X 55 931- 8.8A3C	SCREW	VIS	1		
93	A702893	SCHEIBE SICH 10 6799 DAC	WASHER	RONDELLE	1		
94	A703005	SHB 6,4 9021-ST A3S	WASHER	RONDELLE	1		
95	A703813	MU 6KT 10 985-10 A3B	NUT	ECROU	4		
96	A704138	SHR 6X 16 603- 4.6A3B	SCREW	VIS	4		
97	A704264	BOLZ A 5 H11X 14 EN22341- A3F	PIN	PIVOT	1		
98	A704368	SHR 6X 18 933- 8.8A3C	SCREW	VIS	2		
99	A704534	MU 10 934- 8 A3B	NUT	ECROU	4		
100	A704536	MUTTER 6KT 6 985- 8 A3B	NUT	ECROU	10		
101	A704537	MU 6KT 8 985- 8 A3B	NUT	ECROU	12		
102	A704540	SCHEIBE A 13 125-ST A3B	WASHER	RONDELLE	1		
103	A704546	SHR 8X 20 933- 8.8A3B	SCREW	VIS	2		

Crossover
74 / 13
Art. 65053
 2007
 3-7



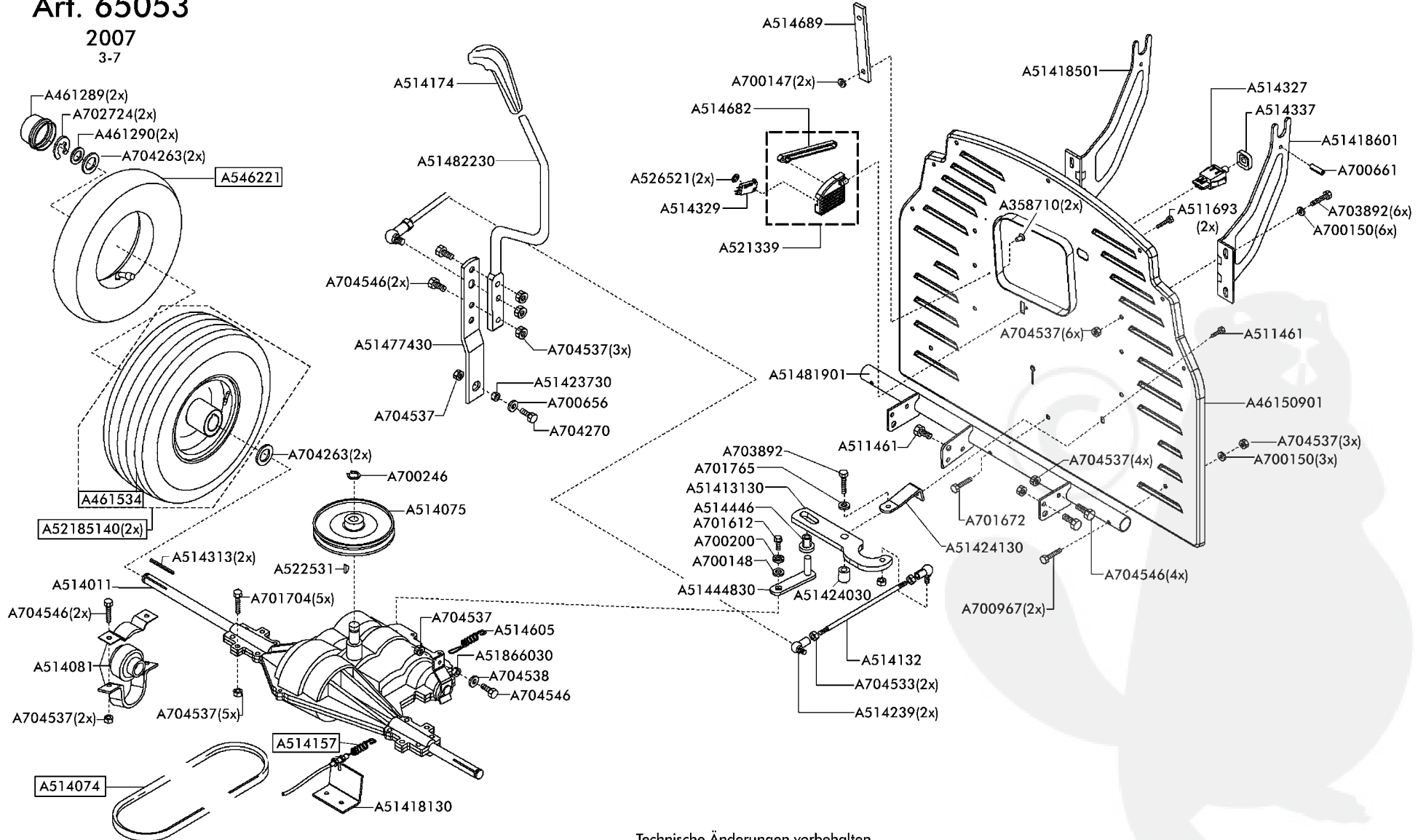

GETRIEBE
 TRANSMISSION
 TRANSMISSION

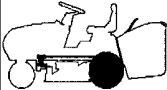

Technische Änderungen vorbehalten

8/22		RASENTRAKTOREN		Crossover	
2007		LAWN TRACTORS		74 / 13 - Art. 65053	
Rev073703		Tracteurs de pelouse		Modell 2007	
Bild Nr. REF.N° POS.N°	BEST.-NR. PART.-N° N° d. PIECE	BEZEICHNUNG	DESCRIPTION	DÉSIGNATION	Qty.
1	A358710	NIET BLIND-4.8-ST-VZ 10 MM	RIVET	RIVET	2
2	A51866030	DISTANZHÜLSE-TOTMANN VERZ	SPACER	DOUILLE	1
3	A461289	ABDECKKAPPE"TRAKTOR"	HUB COVER	COUVRE MOYEU	2
4	A461290	SCHEIBE 42MM FÜR TRAKTOR	WASHER	RONDELLE	2
5	A46150901	RÜCKWAND 2 R9005	PLATE	PLAQUE	1
6	A461534	MANTEL FÜR REIFEN 18X6,50-8 2PR	TIRE 18X6,50-8 2PR	PNEU 18X6,50-8 2PR	2
7	A511461	SCHRTAPT-EJOT8X16 1347A A3B	SCREW	VIS	2
8	A511693	SCHRAUBE PT-KB 5X10 WN1411 A3B	SCREW	VIS	2
9	A514011	SCHALTGETRIEBE 5-GANG MST 205-540 D	GEARBOX ASSY. MST 205-540 D	TRANSMISSION CPL MST 205-540 D	1
10	A514074	KEILRIEMEN FAHRANTRIEB	BELT	COURROIE	1
11	A514075	KEILRIEMENSCHLEIBE GETRIEBE 5-GANG KPL	PULLEY ASSY	POULIE	1
12	A514081	Y-STEHLAGER 3/4"	SUPPORT ASSY	SUPPORT CPL	1
13	A51413130	ANSTEUERHEBEL SCHALTGETRIEBE VERZ	LEVER	LEVIER	1
14	A514132	VERBINDUNGSSTANGE-SCHALTGETRIEBE	CONNECTION ROD	BARRE DE CONNECTION	1
15	A514157	SCHALT-BOWDENZUG-BREMSE	BOWDEN CABLE	FIL	1
16	A514174	SCHALTGRIF	KNOB	POIGNEE	1
17	A51418130	WIDERLAGER BREMSE VERZ.	SUPPORT ASSY	SUPPORT CPL	1
18	A51418501	LAGERARM RE.LACK R9005	SUPPORT RIGHT	SUPPORT DROITE	1
19	A51418601	LAGERARM LI LACK R9005	SUPPORT LEFT	SUPPORT GAUCHE	1
20	A51423730	DISTANZBUCHSE VERZ.	SPACER	ENTRETOISE	1
21	A514239	WINKELGELENK C13SXN68/02R	JOINT	JOINT	2
22	A51424030	DISTANZHÜLSE-SCHALTUNG VERZ	SPACER	DOUILLE	1
23	A51424130	BEFESTIGUNGSBÜGEL SCHALTUNG VERZ	PLATE	PLAQUE	1
24	A514313	PASSFEDER 3/16"X3/16"X2 1/4	FIT-IN KEY	GOUPILLE	2
25	A514327	DRUCKSCHALTER	PRESS SWITCH	INTERRUPTEUR À PRESSION	1
26	A514329	MIKROSCHALTER FÜLLSTANDANZEIGE	SWITCH	INTERRUPTEUR	1
27	A514337	ABDECKTÜLLE FÜR DRUCKSCHALTER	COVER	COUVERCLE PROTECTION	1
28	A514446	GLEITBUCHSE SCHALTUNG	SLIDING BUSHING	DOUILLE GLISSEMENT	1
29	A51444830	GETRIEBESCHALTHEBEL GESCHW VERZ	LEVER	LEVIER	1
30	A514605	RÜCKSTELLFEDER BREMSHEBEL	SPRING PLATE	RESSORT	1
31	A514682	SCHALTHEBEL LANG	LEVER	LEVIER	1
32	A514689	SCHUTZLAPPEN	GUARD	GUARD	1
33	A51477430	FEDERBLECH SCHALTUNG VERZ	SPRING PLATE	MACARON RESSORT	1
34	A51481901	VERSTEIFUNGSROHR SG GESCHW R9005	TUBE	CARNEAU	1
35	A51482230	SCHALTHEBEL VERZ	LEVER	LEVIER	1
36	A521339	FÜLLSTANDSUMMERGEHÄUSE UND HEBEL	PROTECTION COVER & LEVER CPL	COUVERCLE PROTECTION & LEVIER CPL	1
37	A52185140	HINTER-RAD 18X6.5-8 SCHMAL KPL R9006	REAR WHEEL 18X6.5-8	ROUE ARRIERE 18X6.5-8	2
38	A522531	SCHEIBENFEDER 3/16"X3/4"	LOCK WASHER	DISQUE DE RESSORT	1

9/22		RASENTRAKTOREN		 GETRIEBE TRANSMISSION TRANSMISSION	Crossover		 
2007		LAWN TRACTORS			74 / 13 - Art. 65053		
Rev073703		Tracteurs de pelouse			Modell 2007		
Bild Nr. REF.N° POS.N°	BEST.-NR. PART-N°. N° d. PIECE	BEZEICHNUNG	DESCRIPTION	DÉSIGNATION	Qty.		
39	A526521	SCHNELLBEFESTIGER 3SXN26	CROWN FASTENER	FIXATEUR A COURONNE	2		
40	A546221	SCHLAUCH 18"X6.5"-8 TR13	TUBE	TUYAU	2		
41	A700147	SCHEIBE 5,3 9021-ST VZ	WASHER	RONDELLE	2		
42	A700148	SHB 6,4 9021-ST VZ	WASHER	RONDELLE	1		
43	A700150	SCHEIBE 8,4 9021-ST VZ	WASHER	RONDELLE	9		
44	A700200	SHB FÄCHER- J 6,4 6798 VZ	SERRATEC WASHER	RONDELLE	1		
45	A700246	RING SICHT 16X1 471	CIRCLIP	CIRCLIPS	1		
46	A700656	FED TEL 28 X10,2X1,25 2093	DISK SPRING	DISQUE	1		
47	A700661	HUEL SPAN 6 X 20 1481	BUSHING	DOUILLE	1		
48	A700967	SHR 8X 35 603- 4.6VZ	SCREW	VIS	2		
49	A701612	SCHR SKT UNF 1/ 4"X12	SCREW	VIS	1		
50	A701672	SCHRAUBE	SCREW	VIS	1		
51	A701704	SHR 8X 60 933- 8.8VZ	SCREW	VIS	5		
52	A701765	SHB FÄCHER- A 8,4 6798 VZ	WASHER	RONDELLE	1		
53	A702724	SCHEIBE SICHT 15 6799 VZ	WASHER	RONDELLE	2		
54	A703892	SCHRAUBE 8X 45 933- 8.8A3B	SCREW	VIS	6		
55	A704263	SHB S 19X26X1,5 988A3C	WASHER	RONDELLE	4		
56	A704270	SHR 8X25 EN ISO7380-10.9A3C	SCREW	VIS	1		
57	A704533	MUTTER 8 934- 8 A3B	NUT	ECROU	2		
58	A704537	MUTTER 6KT 8 985- 8 A3B	NUT	ECROU	25		
59	A704538	SCHEIBE A 8,4 125-ST A3B	WASHER	RONDELLE	3		
60	A704546	SCHRAUBE 8X 20 933- 8.8A3B	SCREW	VIS	9		



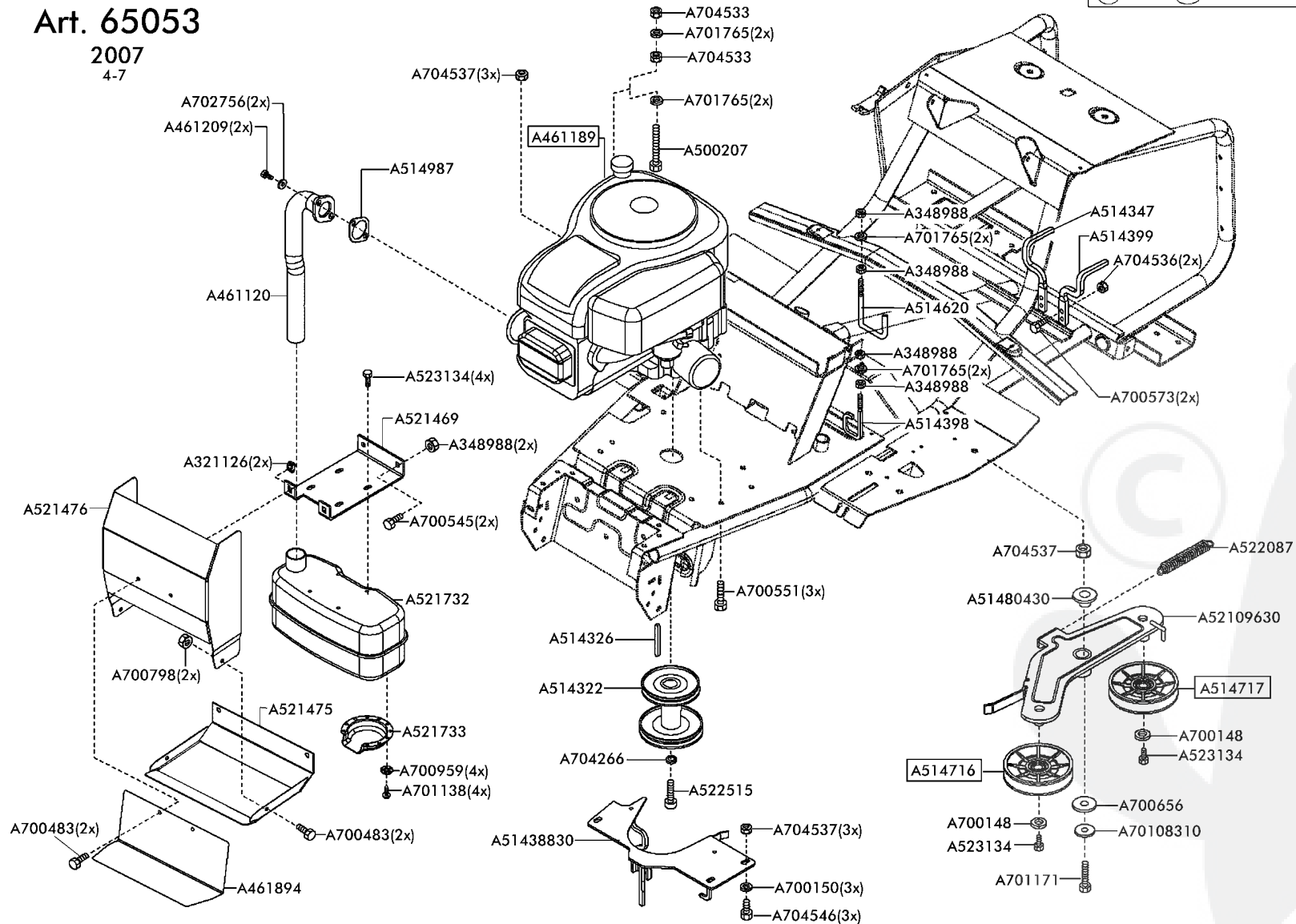
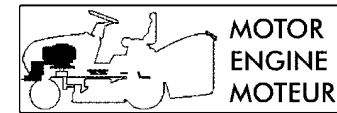

Crossover
74 / 13
Art. 65053
 2007
 4-7



Technische Änderungen vorbehalten

11/22	RASENTRAKTOREN		MOTOR	Crossover	
2007	LAWN TRACTORS		ENGINE	74 / 13 - Art. 65053	
Rev073703	Tracteurs de pelouse		MOTEUR	Modell 2007	
Bild Nr. REF.N° POS.N°	BEST.-NR. PART-N° N° d. PIECE	BEZEICHNUNG	DESCRIPTION	DÉSIGNATION	Qty.
1	A321126	MUTTER KASTEN- M 6-ST GALVZ+PASSI	SQUARE NUT	ECROU	2
2	A348988	MUTTER SICHT- BIW M 8 A3C- 8 MITTELGESICHT	NUT	ECROU	8
3	A461120	KRÜMMER B&S AUSPUFF GESCHW	EXHAUST CONNECTING TUBE	TUBE DE CONNEXION	1
4	A461189	MOTOR B&S 13HP IC OHV AVS	ENGINE 13HP IC OHV AVS	MOTEUR 13HP IC OHV AVS	1
5	A461209	SCHRAUBE ISKT UNC 5/16"X 3/4"A3B	SCREW	VIS	2
6	A461894	ABWEISBLECH	PLATE	PLATEAU	1
7	A500207	SHR 8X 50 VERBUS RIPP A3R 8.8	SCREW	VIS	1
8	A514322	ANTRIEBSSEGMENT 82/HYDRO	SEGMENT	SEGMENT	1
9	A514326	PASSFEDER 1/4"X1/4"X1 3/4	FIT IN KEY	CLAVETTE	1
10	A51438830	RIEMENFÜHRUNG GESCHW 115 VERZ	BELT GUIDE	GUIDE	1
11	A514347	RIEMENFÜHRUNG HINTEN RECHTS	BELT GUIDE RIGHT	GUIDAGE DROITE	1
12	A514398	ÖSE-RIEMENFÜHRUNG MITTE	BELT GUIDE	GUIDAGE	1
13	A514399	RIEMENFÜHRUNG HINTEN	REAR BELT GUIDE	GUIDAGE	1
14	A514620	HALTEBÜGEL	SUPPORT	SUPPORT	1
15	A514716	SPANNROLLE INNEN +LAGER	TENSIONER INSIDE ASSY	ROUE SERRAGE	1
16	A514717	SPANNROLLE AUSSEN+LAGER	TENSION ROLL ASSY. OUTSIDE	ROUE SERRAGE À L'EXTÉRIEUR	1
17	A51480430	DISTANZBUCHSE WIPPE VERZ	SPACER	ENTRETOISE	1
18	A514987	FLANSCHDICHTUNG B&S 27229	FLANGE SEAL	JOINT	1
19	A52109630	SPANNROLLENWIPPE D16 GESCHW VERZ	LEVER D16	LEVIER D16	1
20	A521469	AUSPUFFHALTEBLECH	SUPPORT	SUPPORT	1
21	A521475	WÄRMELEITBLECH UNTEN H-4 UND 2 ZYLINDER	LOWER GUARD	GUARD EN BAS	1
22	A521476	LUFTLEITBLECH 2-ZYLINDER	AIR GUIDE	DÉFLECTEUR	1
23	A521732	AUSPUFF B&S P 498984	MUFFLER	SILENCEUX	1
24	A521733	DEFLECTOR B&S P 222573	DEFLECTOR	DEFLECTEUR	1
25	A522087	ZUGFEDER-BBC	SPRING	RESSORT	1
26	A522515	SCHR ISKT UNF 7/16"X1 1/4 A3S 12.9	SCREW	VIS	1
27	A523134	SFS-TAPT.M6X12 2021 A2K	SCREW	VIS	6
28	A700148	SCHEIBE 6,4 9021-ST VZ	WASHER	RONDELLE	2
29	A700150	SCHEIBE 8,4 9021-ST VZ	WASHER	RONDELLE	3
30	A700483	SCHRAUBE 6X 12 933- 8.8VZ	SCREW	VIS	4
31	A700545	SCHRAUBE 8X 16 933- 8.8VZ	SCREW 8X 16 933- 8.8VZ	VIS 8X 16 933- 8.8VZ	2
32	A700551	SCHRAUBE 8X 35 933- 8.8A3C	SCREW	VIS	3
33	A700573	SCHRAUBE 6X 20 603- 4.6VZ	SCREW	VIS	2
34	A700656	FED TEL 28 X10,2X1,25 2093	DISK SPRING	DISQUE	1
35	A700798	MU 6KT 6 980-V- 8	NUT	ECROU	2
36	A700959	SHB FÄCHER- A 4,3 6798 VZ	WASHER	RONDELLE	4
37	A70108310	SCHEIBE 8,4VZ7349"701083"	WASHER	RONDELLE	1



12/22	RASENTRAKTOREN		MOTOR ENGINE MOTEUR	Crossover		 
2007	LAWN TRACTORS			74 / 13 - Art. 65053		
Rev073703	Tracteurs de pelouse			Modell 2007		
Bild Nr. REF.N° POS.N°	BEST.-NR. PART-N°. N° d. PIECE	BEZEICHNUNG	DESCRIPTION	DÉSIGNATION	Qty.	
38	A701171	SCHRAUBE 8X 30 933- 8.8VZ	SCREW	VIS	1	
39	A701765	SCHEIBE FÄCHER- A 8,4 6798 VZ	WASHER FÄCHER- A 8,4 6798 VZ	RONDELLE FÄCHER- A 8,4 6798 VZ	8	
40	A702756	SCHEIBE SICH SCHNORR S 8 MECHANVZ	WASHER	RONDELLE	2	
41	A704266	SHB FÄCHER- J 13,0 6798 A3C	WASHER	RONDELLE	1	
42	A704533	MUTTER 8 934- 8 A3B	NUT	ECROU	2	
43	A704536	MUTTER 6KT 6 985- 8 A3B	NUT	ECROU	2	
44	A704537	MUTTER 6KT 8 985- 8 A3B	NUT	ECROU	7	
45	A704546	SCHRAUBE 8X 20 933- 8.8A3B	SCREW	VIS	3	
46	A711138	SCHRAUBE B&S	SCREW B&S	VIS B&S	4	

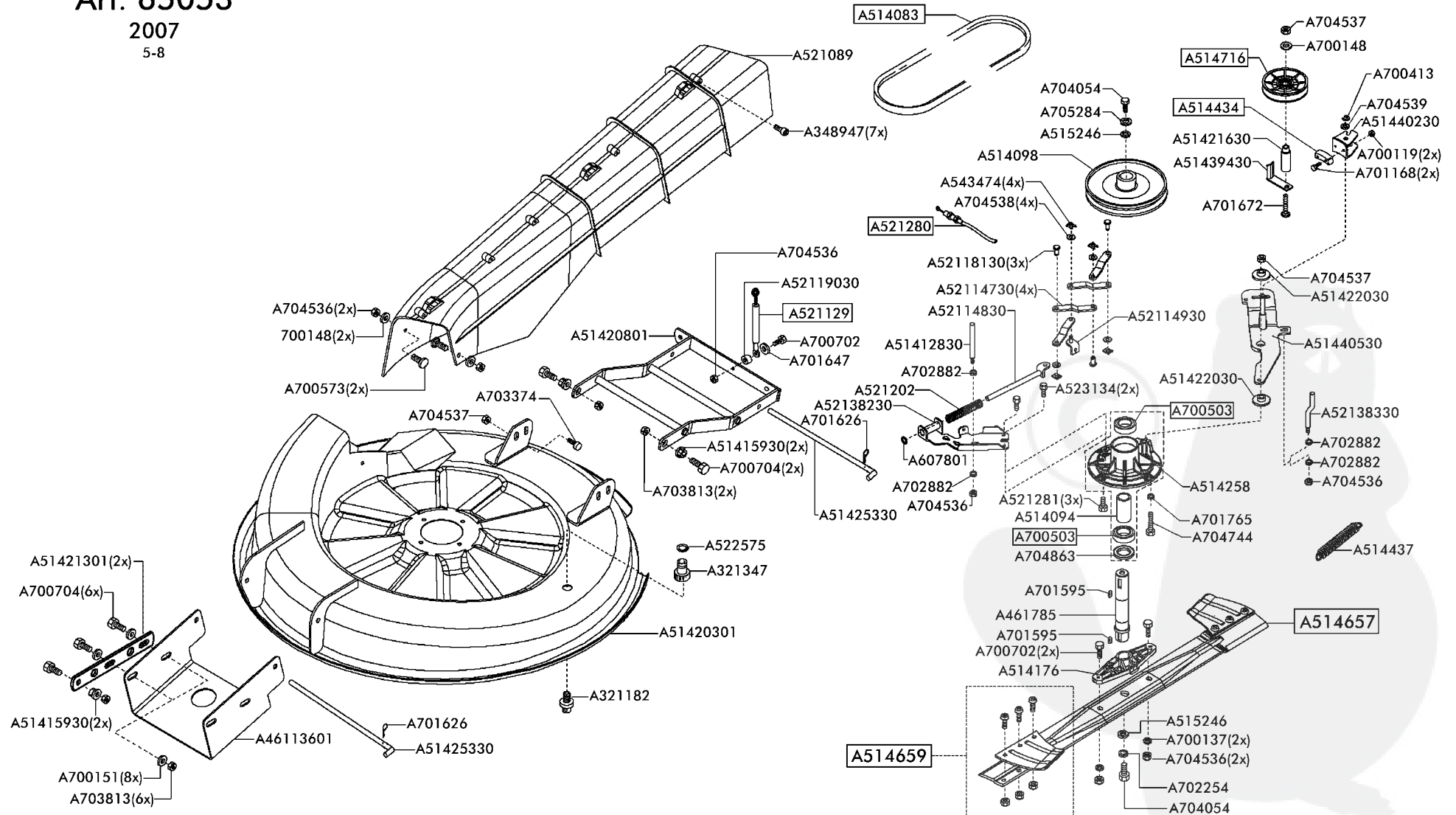

Crossover
74 / 13
Art. 65053
 2007
 5-8



14/22		RASENTRAKTOREN	 SCHNEIDWERK CUTTING PLATE PLATEAU DE COUPE	Crossover		  <small>BRILL GLORIA</small>	
2007		LAWN TRACTORS		74 / 13 - Art. 65053			
Rev073703		Tracteurs de pelouse		Modell 2007			
Bild Nr. REF.N° POS.N°	BEST.-NR. PART.-N° N° d. PIECE	BEZEICHNUNG	DESCRIPTION	DÉSIGNATION	Qty.		
1	A321182	SPÜLDÜSE R1/2"	WATER HOSE CONNECTION	RACCORD TUYAU D'EAU	1		
2	A321347	ANSCHLUSS R1/2"	TUBE ADAPTER	ADAPTER TUYAU	1		
3	A348947	SCHRAUBE PT-KB 60X20 1442	SCREW	ECROU	7		
4	A46113601	MÄHDECKAUFHÄNGUNG VORNE R9005	CUTTING PLATE SUPPORT FRONT	PLATEAU SUSPENSION L'AVANT	1		
5	A461785	MESSERWELLE TRAKTOR VERZ	BLADE SHAFT	ABRE	1		
6	A514083	KEILRIEMEN MÄHWERK	BELT	COURROIRE	1		
7	A514094	DISTANZBUCHSE-1	SPACER	ENTRETOISE	1		
8	A514098	KEILRIEMENSCHLEIBE MÄHANTRIEB	PULLEY	POULIE	1		
9	A51412830	FÜHRUNGSSTANGE VERZ.	ROD	BARRE	1		
10	A51415930	DISTANZSCHEIBE VERZ	SPACER	ENTRETOISE	4		
11	A514176	MESSERHALTER	BLADE FLANGE	BRIDE	1		
12	A51420301	SCHNEIDGEHÄUSE 74 GESCHW R9005	CUTTING PLATE 74	PLATEAU 74	1		
13	A51420801	HÖHENVERSTELLUNG HINTEN GESCHW R9005	REAR HIGH ADJUSTMENT FRAME	DEPLACEMENT EN HAUTEUR ARRIERE	1		
14	A51421301	SCHENKEL-VORNE HÖHENVERSTELLUNG R9005	SUPPORT	SUPPORT	2		
15	A51421630	ZENTRIERHÜLSE VERZ.	BUSH	DOUILLE	1		
16	A51422030	DISTANZSCHEIBE VERZ	SPACER	ENTRETOISE	2		
17	A51425330	ABSTECKSTANGE VERZ.	ROD	BARRE	2		
18	A514258	LAGERBOCK KPL.	BLADE FLANGE ASSY. CPL	ENS. BRIDE POUR LAME CPL	1		
19	A51439430	RIEMENFÜHRUNG VERZ	BELT GUIDE	GUIDE	1		
20	A51440230	BREMSBACKEN VERZ	BRAKE SHOE	SEGMENT DE FREIN	1		
21	A51440530	SPANN-BREMSHEBEL GESCHW VERZ	BOLT LEVER	LEVIER DE SERRAGE	1		
22	A514434	BREMSKLOTZ	BRAKE PAD	PLACETTE DE FREIN À DISQUE	1		
23	A514437	BREMSFEDER	BRAKE SPRING	FRENAGE À RESSORT	1		
24	A514657	MESSER KOMPLETT 74 CM	BLADE 74 CM	LAME 74 CM	1		
25	A514659	MESSERSCHAUFEL 8.5 KP.ET	BLADE WING SET	LAME FLANK	1		
26	A514716	SPANNROLLE INNEN +LAGER	TENSIONER INSIDE ASSY	ROUE SERRAGE	1		
27	A515246	SCHEIBE 30/10,5 X 5	WASHER	RONDELLE	2		
28	A521089	AUSWURFKANAL VERSCHRAUBT R9005	CONVEYOR ASSY.	ENS. CONVOYEUR	1		
29	A521129	BOWDENZUG HÖHENVSTELLUNG 82	BOWDEN CABLE	CABLE BOWDEN	1		
30	A52114730	LASCHE PKR 74/82 VERZ	PLATE	LANGUETTE	4		
31	A52114830	SCHUBSTANGE GESCHW PKR VERZ	PUSH ROD	BARRE POUSSE	1		
32	A52114930	WINKEL PKR 74/82 VERZ	BRACKET	JARRET	1		
33	A52118130	BOLZEN PKR 74/82 VERZ.	PIN	PIVOT	3		
34	A52119030	PENDELHÜLSE HÖHENVERSTELLUNG VERZ	BUSH	DOUILLE	1		
35	A521202	DRUCKFEDER	PRESSURE SPRING	RESSORT DE PRESSION	1		
36	A521280	BOWDENZUG-MESSERBREMSE	BOWDEN CABLE /BRAKE	CABLE BOWDEN /FREIN	1		
37	A521281	SCHRAUBE-TAPT 8X25 SPERRZ.A3S	SCREW	VIS	3		

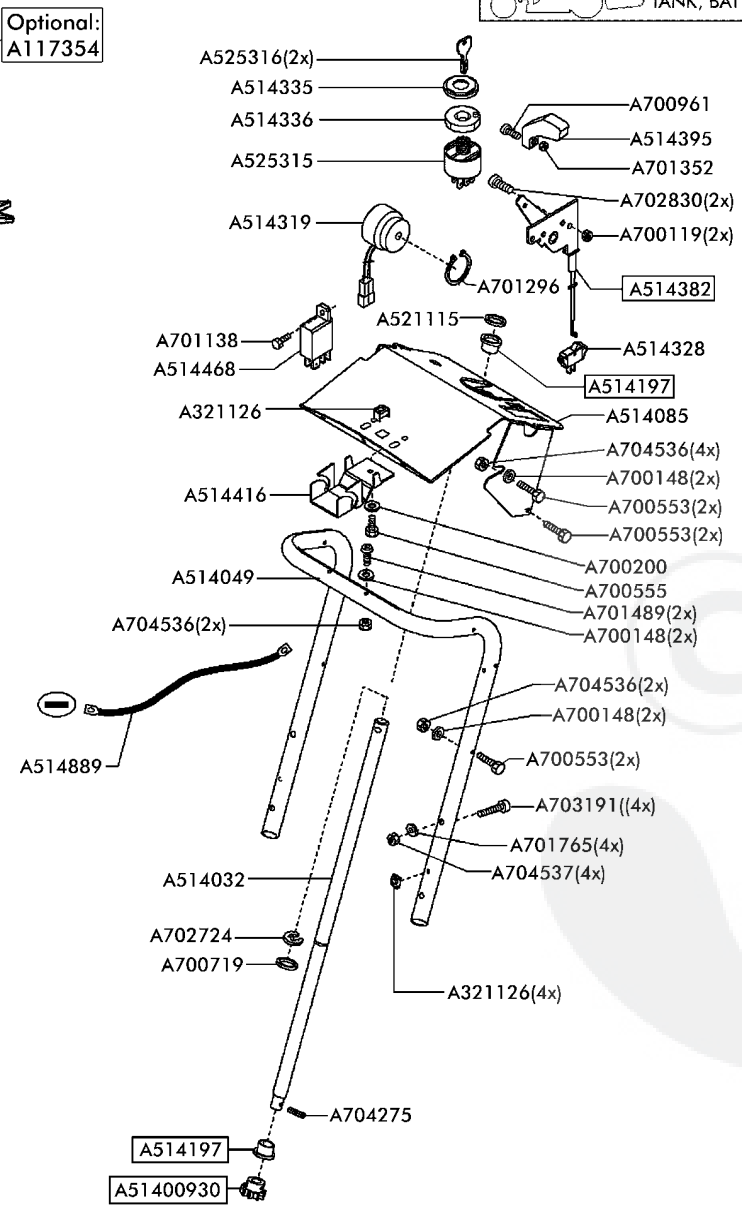
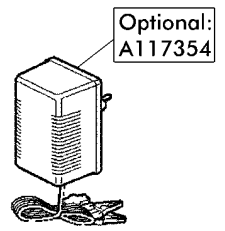
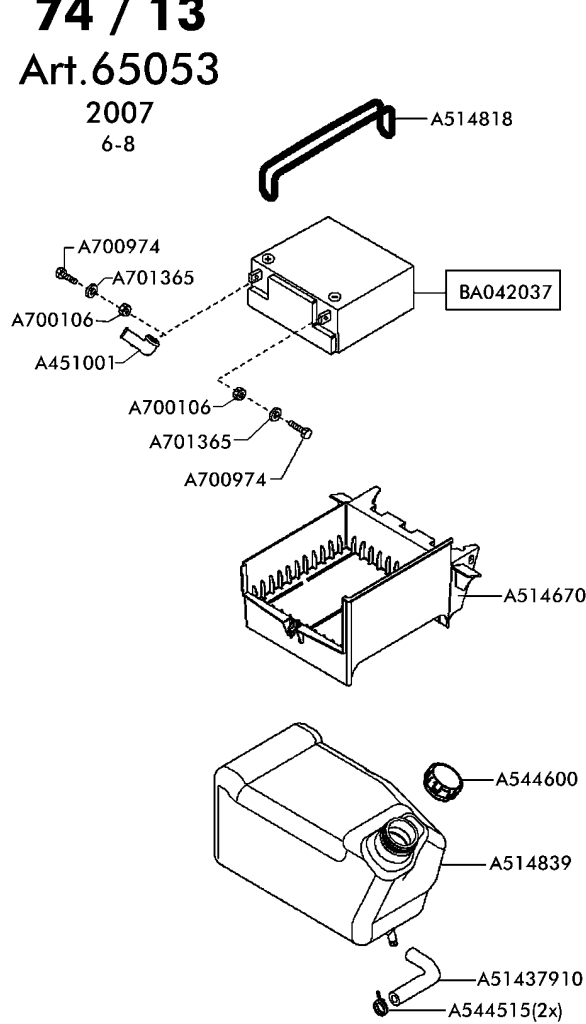

15/22		RASENTRAKTOREN	 SCHNEIDWERK CUTTING PLATE PLATEAU DE COUPE	Crossover		  <small>GRASS FOR HOME AND GARDEN</small>
2007		LAWN TRACTORS		74 / 13 - Art. 65053		
Rev073703		Tracteurs de pelouse		Modell 2007		
Bild Nr. REF.N° POS.N°	BEST.-NR. PART-N° N° d. PIECE	BEZEICHNUNG	DESCRIPTION	DÉSIGNATION	Qty.	
38	A52138230	HALTEBLECH GESCHW VERZ	SUPPORT	SUPPORT	1	
39	A52138330	FÜHRUNGSSTANGE GEKRÖPFT VERZ	ROD	BARRE	1	
40	A522575	O-RING D10,78X2,62 NBR	O-RING	O-RING	1	
41	A523134	SFS-TAPT.M6X12 2021 A2K	SCREW	VIS	2	
42	A543474	SL SICHERUNG 8SXNO8	SNAP RING 8SXNO8	CIRCLIPS 8SXNO8	4	
43	A607801	SCHNELLBEFESTIGER10SXN26	Quick-fixing-device	Starlock	1	
44	A700119	MUTTER 6KT 5 985- 8 VZ	NUT	ECROU	2	
45	A700137	SCHEIBE A 6,4 125-ST VZ	WASHER	RONDELLE	2	
46	A700148	SCHEIBE 6,4 9021-ST VZ	WASHER	RONDELLE	3	
47	A700151	SCHEIBE 10,5 9021-ST VZ	WASHER	RONDELLE	8	
48	A700413	Sicherungsring DIN 471 10x1	CIRCLIP DIN 471 10x1	JOINT SPI	1	
49	A700503	KUGELLAGER 6205 2RS 625	BALL BEARING	ROULEMENT À BILLES	2	
50	A700573	SCHRAUBE 6X 20 603- 4.6VZ	SCREW	VIS	2	
51	A700702	SCHRAUBE 6X 25 933- 8.8VZ	SCREW	VIS	3	
52	A700704	SCHRAUBE10X 30 933- 8.8VZ	SCREW	VIS	8	
53	A701168	SHR ZYL 5 X20 84 VZ	SCREW	VIS	2	
54	A701595	PASSFEDER 8X7X20 6885	FIT-IN KEY	GOUPILLE	2	
55	A701626	FEDERSTECKER - 2,5 11024 VZ	COTTER PIN	GOUPILLE	2	
56	A701647	SHB R 6,6 VZ 440	WASHER	RONDELLE	1	
57	A701672	Schraube	SCREW	VIS	1	
58	A701765	SCHEIBE FÄCHER- A 8,4 6798 VZ	WASHER FÄCHER- A 8,4 6798 VZ	RONDELLE FÄCHER- A 8,4 6798 VZ	1	
59	A702254	SCHEIBE FÄCHER- A 10,5 6798 VZ	WASHER	RONDELLE	1	
60	A702882	SHB A 6,4 125-ST A3S	WASHER	RONDELLE	4	
61	A703374	SHR 8X 16 912- 8.8A3R	SCREW	VIS	1	
62	A703813	MUTTER 6KT 10 985-10 A3B	NUT	ECROU	8	
63	A704054	SCHRAUBE10X1,0 X 35 961- 8.8	SCREW	VIS	2	
64	A704536	MUTTER 6KT 6 985- 8 A3B	NUT	ECROU	7	
65	A704537	MUTTER 6KT 8 985- 8 A3B	NUT	ECROU	3	
66	A704538	SCHEIBE A 8,4 125-ST A3B	WASHER	RONDELLE	4	
67	A704539	SHB A 10,5 125-ST A3B	WASHER	RONDELLE	1	
68	A704744	SCHRAUBE 8X 65 931- 8.8A3B	SCREW	VIS	1	
69	A704863	RWDR AS 30X 52X 5 3760-NB	WASHER	RONDELLE	1	
70	A705284	TELLERFEDER 28 X10,2X1,5 2093	DISK SPRING	RESSORT D'ASSIETTE	1	

Crossover
74 / 13
Art. 65053
 2007
 6-8

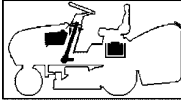

Technische Änderungen vorbehalten

17/22		RASENTRAKTOREN		 TANK, BATTERIE & KOMPONENTEN TANK, BATTERY & COMPONENTS TANK, BATTERIE & COMPOSANTS		Crossover		74 / 13 - Art. 65053 Modell 2007		 	
2007		LAWN TRACTORS				Rev073703					
Bild Nr. REF.N° POS.N°	BEST.-NR. PART-N° N° d. PIECE	BEZEICHNUNG	DESCRIPTION	DÉSIGNATION	Qty.						
1	A117354	LADEGERÄT Crossover 12 V (optional)	CHARGER Crossover 12 V (optional)	CHARGEUR Crossover 12 V (optional)	1						
2	A321126	MUTTER KASTEN- M 6-ST GALVZ+PASSI	NUT	ECROU	4						
3	A451001	BATTERIEPOLABDECKUNG FÜR BATTERIE CSB	POL COVER	COUVERCLE DE PROTECTION	1						
4	A51400930	LENKUNGSRITZEL VERZ.	STEERING WHEEL	PIGNON	1						
5	A514032	LENKSÄULE VERZ	STEERING COLUMN	TUBE DE DIRECTION	1						
6	A514049	STÜTZHOLM	SUPPORT	SUPPORT	1						
7	A514085	STÜTZBLECH	SUPPORT	SUPPORT	1						
8	A514197	EP-BUNDBUCHSE	BUSH	DOILLE	2						
9	A514319	FÜLLSTANDSUMMER	BUZZER (GRASS BAG FULL)	BUZZER	1						
10	A514328	KIPPSCHALTER LICHT	ROCKER SWITCH I/O	INERRUPTEUR À BASCULE	1						
11	A514335	BEFESTIGUNGS MUTTER ZÜNDSCHLOSS	LOCK NUT	EMBOU	1						
12	A514336	VERDREHSICHERUNG ZÜNDSCHLOSS	SAFETY NUT	EMBOU	1						
13	A51437910	BENZINSCHLAUCH ZUSCHNITT	CONNECTING TUBE	TUBE DE CONNEXION	1						
14	A514382	GASFERNBEDIENUNG	ACCELERATOR	ACCELERATEUR	1						
15	A514395	BEDIENHEBEL	LEVER	LEVIER	1						
16	A514416	EINRASTBLECH	ENGAGE PLATE	PANNEAU ENCLIQUETER	1						
17	A514468	MIKRORELAIS 12V 10/20A	MICROSWITCH	MICROINTERRUPTEUR	1						
18	A514670	BATTERIEKASTEN	BATTERY INSERT	BATTERIE CAISSE	1						
19	A514818	BEFESTIGUNGSGUMMI	RUBBER BAND	ÉLASTIQUE	1						
20	A514839	BENZINTANK	TANK	RESERVOIR	1						
21	A514889	ZUSATZ MASSEKABEL	GROUND CABLE	CABLE	1						
22	A521115	SCHNELLBEFESTIGER20SXN26	CROWN FASTENER	FIXATEUR A COURONNE	1						
23	A525315	ZÜNDANLASSCHALTER RIDER	IGNITION SWITCH	INTERRUPTEUR DEMARR. /1	1						
24	A525316	ZÜNDSCHLÜSSEL	STARTING KEY	CLEF A DEMARRAGE	2						
25	A544515	SCHLAUCHKLEMME 14,5	TUBE CLAMP	BORNE	2						
26	A544600	TANKDECKEL KPL	TANK CAP	BOUCHON DE RÉSERVOIR	1						
27	A700106	MUTTER 5 934- 8 VZ	NUT	ECROU	2						
28	A700119	MUTTER 6KT 5 985- 8 VZ	NUT	ECROU	2						
29	A700148	SCHEIBE 6,4 9021-ST VZ	WASHER	RONDELLE	6						
30	A700200	SCHEIBE FÄCHER- J 6,4 6798 VZ	WASHER	RONDELLE	1						
31	A700553	SCHRAUBE 6X 40 933- 8.8VZ	SCREW	VIS	6						
32	A700555	SCHRAUBE 6X 16 933- 8.8VZ	SCREW	VIS	1						
33	A700719	SCHEIBE 21 433 VZ	WASHER	RONDELLE	1						
34	A700961	SCHRAUBE 4X 8 7985- 4.8-H VZ	SCREW	VIS	1						
35	A700974	SCHRAUBE 5X 16 933- 8.8VZ	SCREW	VIS	2						
36	A701138	SCHRAUBE ST4,2X13 -C-H7981 VZ	SCREW	VIS	1						
37	A701296	SICHERUNGSRING 25X1,2 471	CIRCLIP	CIRCLIPS	1						

18/22	RASENTRAKTOREN		TANK, BATTERIE & KOMPONENTEN	Crossover		 
2007	LAWN TRACTORS		TANK, BATTERY & COMPONENTS	74 / 13 - Art. 65053		
Rev073703	Tracteurs de pelouse		TANK, BATTERIE & COMPOSANTS	Modell 2007		
Bild Nr. REF.N° POS.N°	BEST.-NR. PART-N°. N° d. PIECE	BEZEICHNUNG	DESCRIPTION	DÉSIGNATION	Qty.	
38	A701352	MUTTER 6KT 4 985- 8 VZ	NUT	ECROU	1	
39	A701365	SCHEIBE FÄCHER- A 5,3 6798 VZ	WASHER	RONDELLE	2	
40	A701489	SCHRAUBE 6X 35 933- 8.8VZ	SCREW	VIS	2	
41	A701765	SCHEIBE FÄCHER- A 8,4 6798 VZ	WASHER FÄCHER- A 8,4 6798 VZ	RONDELLE FÄCHER- A 8,4 6798 VZ	4	
42	A702724	SCHEIBE SICH 15 6799 VZ	WASHER	RONDELLE	1	
43	A702830	SCHRAUBE 5X 12 7985- 4.8-H A3R	SCREW	VIS	2	
44	A703191	SCHRAUBE 8X 40 7991- 8.8A3C	SCREW	VIS	4	
45	A704275	SPANNSTIFT 6X24 7344	PIN	GOUPILLE	1	
46	A704536	MUTTER 6KT 6 985- 8 A3B	NUT	ECROU	8	
47	A704537	MUTTER 6KT 8 985- 8 A3B	NUT	ECROU	4	
48	BA042037	BATTERIE 12V-17Ah	BATTERY 12 V-17Ah	BATTERIE 12V-17Ah	1	



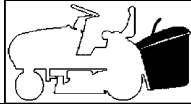

Crossover
74 / 13
Art. 65053
 2007
 7-8

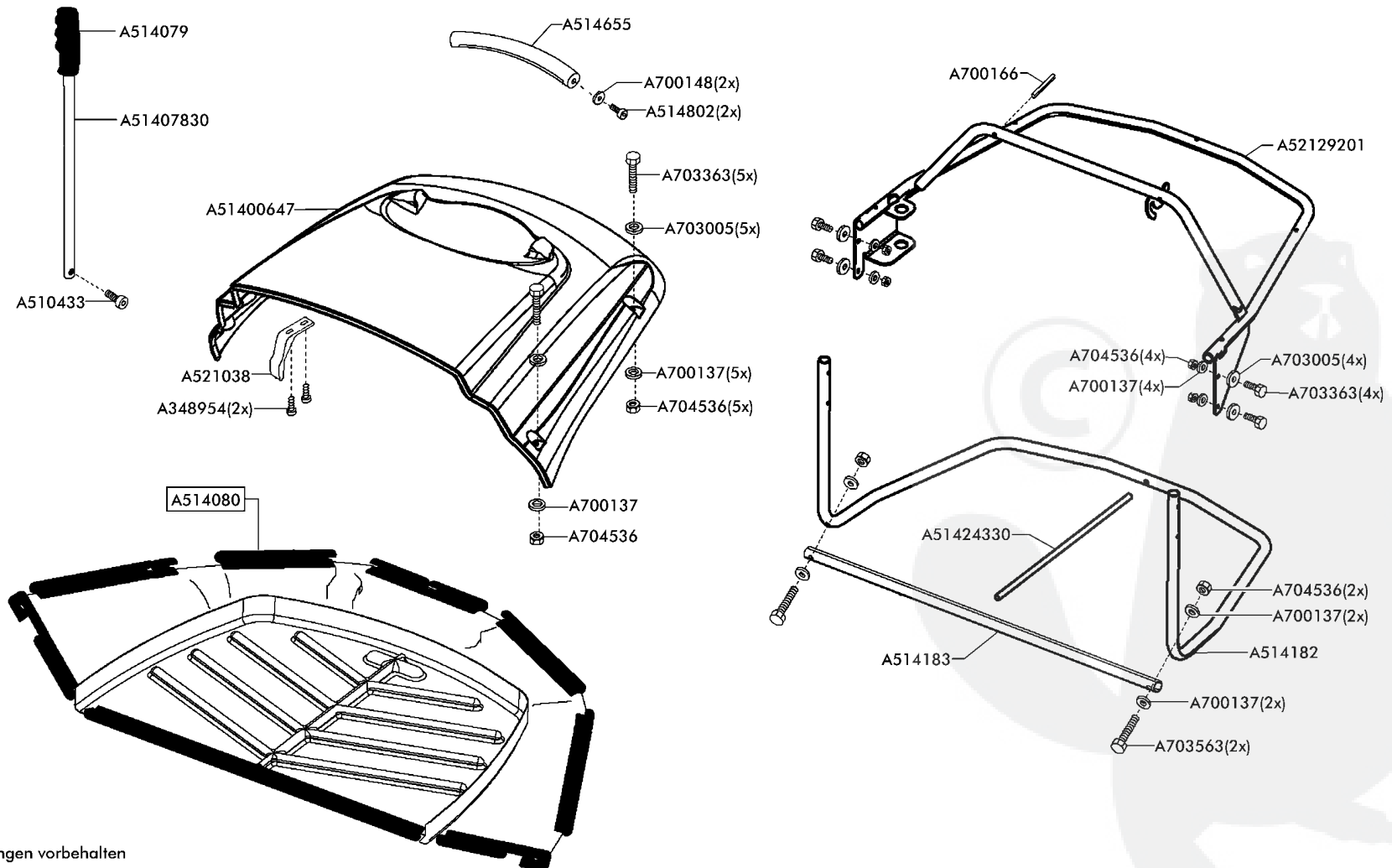
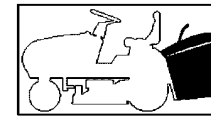

Technische Änderungen vorbehalten

20/22		RASENTRAKTOREN	 GRASFANGSACK KPL. GRASS CATCHER ASSY. BAC COMPOSANTS	Crossover		 
2007		LAWN TRACTORS		74 / 13 - Art. 65053		
Rev073703		Tracteurs de pelouse		Modell 2007		
Bild Nr. REF.N° POS.N°	BEST.-NR. PART-N° N° d. PIECE	BEZEICHNUNG	DESCRIPTION	DÉSIGNATION	Qty.	
1	A348954	SCHRAUBE.PT-KB 60X25 1411 VZ	SCREW	VIS	2	
2	A510433	SCHR SFS-TAPT.6X12 2016	SCREW	VIS	1	
3	A51400647	BOXDECKEL R6001	GRASS-CATCHER COVER GREEN	COUVRE-BAC VERT	1	
4	A51407830	HANDHEBEL BOX VERZ	ROD	TIGE	1	
5	A514079	GRIFF FÜR HANDHEBEL	HANDLE	POINGEE	1	
6	A514080	GEWEBESACK KOMPLETT	GRASSCATCHER	SAC	1	
7	A514182	BOXROHR UNTEN 74/82	LOWER STIFFENING	RENFORCEMENT SUPER.	1	
8	A514183	QUERSTREBE BOX	ROD	TIGE	1	
9	A51424330	LÄNGSSTREBE VERZ	ROD	TIGE	1	
10	A514655	BOXGRIFF TRAKTOR	BOX HANDLE	POIGNEE ANTERIEURE	1	
11	A514802	PT-K 60X20 TORX 1452 VZ	SCREW	VIS	2	
12	A521038	KONTAKTWINKEL	BRACKET	EQUERRE-SUPPORT	1	
13	A52129201	BOXROHR GESCHW 74/82 R9005	UPPER FRAME	CHASSIS SUPERIEUR	1	
14	A700137	SCHEIBE A 6,4 125-ST VZ	WASHER	RONDELLE	14	
15	A700148	SCHEIBE 6,4 9021-ST VZ	WASHER	RONDELLE	2	
16	A700166	HUEL SPAN 6 X 40 1481	SPACER	ENTRETOISE	1	
17	A703005	SCHEIBE 6,4 9021-ST A3S	WASHER	RONDELLE	9	
18	A703363	SHR 6X 35 933- 8.8A3S	SCREW	VIS	9	
19	A703563	SCHRAUBE 6X 45 933- 8.8A3C	SCREW	VIS	2	
20	A704536	MUTTER 6KT 6 985- 8 A3B	NUT	ECROU	12	

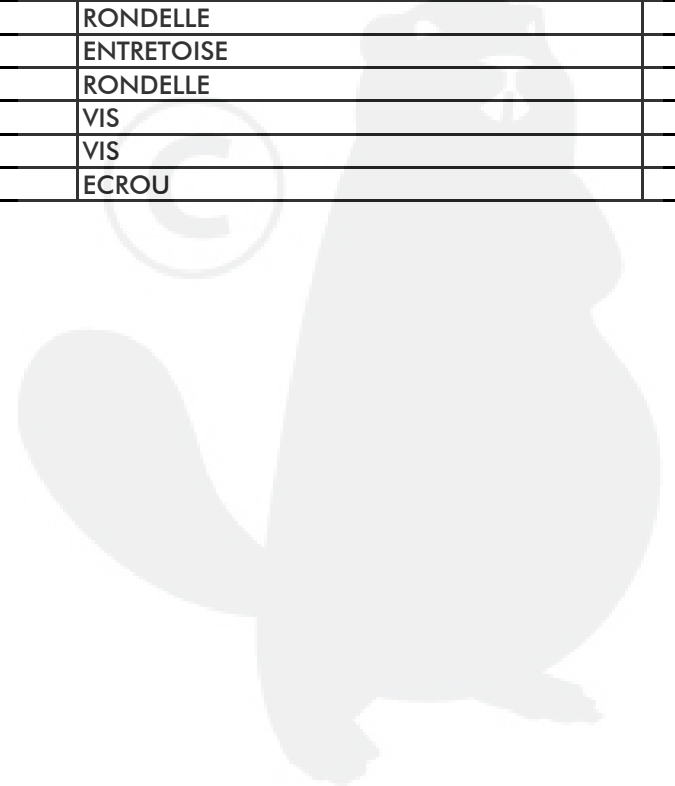

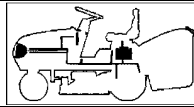

Crossover
74 / 13
Art. 65053

2007
 8-8

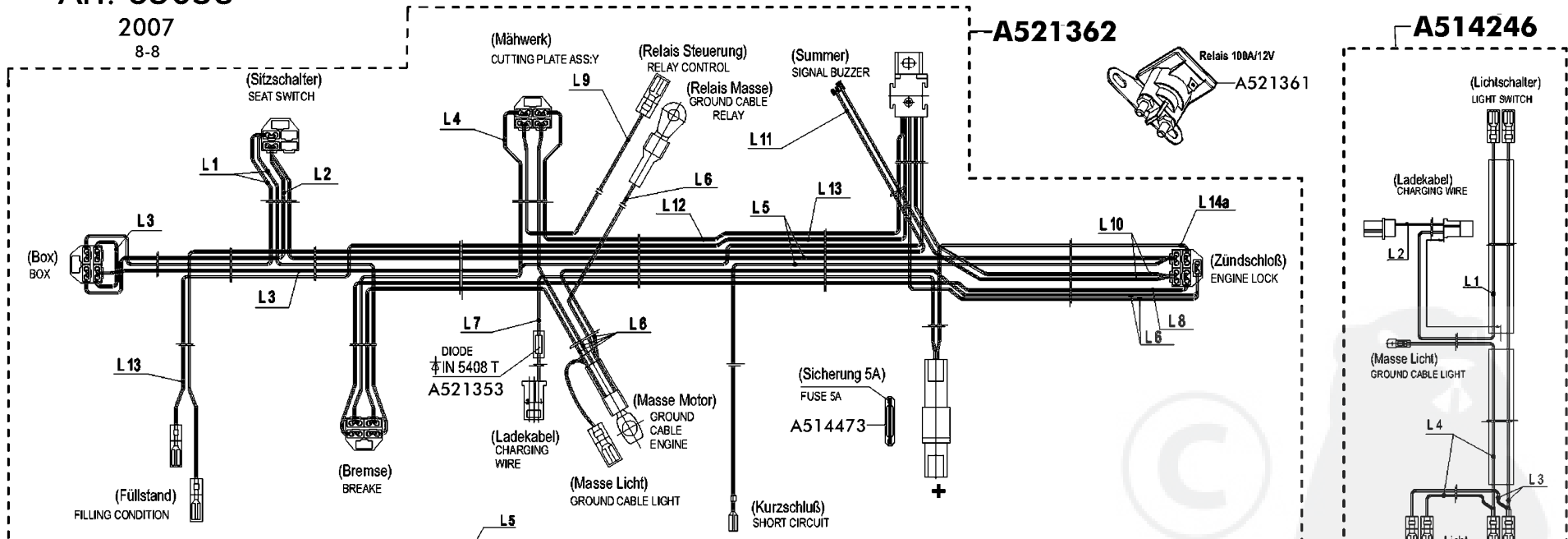
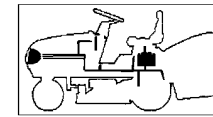

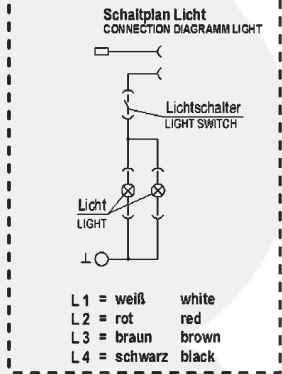
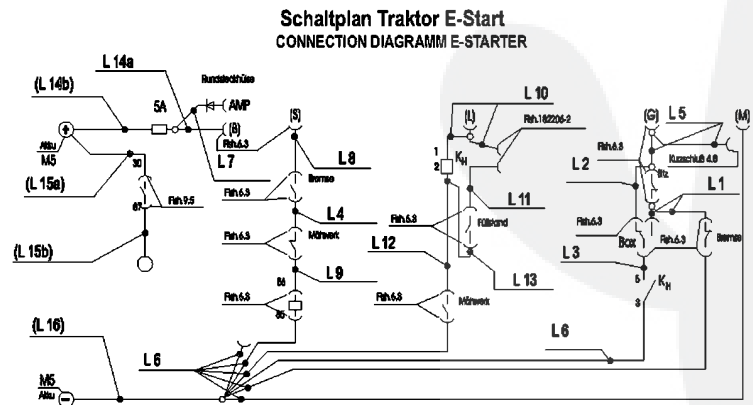
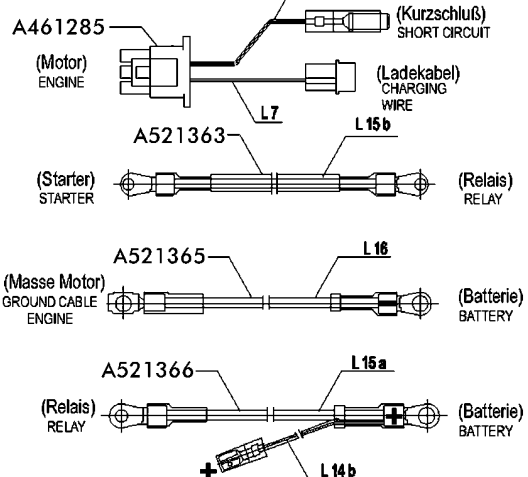

- L1 = rosa pink
- L2 = grau grey
- L3 = weiß white
- L4 = braun brown
- L5 = grün green
- L6 = schwarz black
- L7 = rot red
- L8 = violett violet
- L9 = orange orange
- L10 = gelb yellow
- L11 = blau blue
- L12 = rot/weiß red/white
- L13 = weiß/blau white/blue
- L14 a = rot red
- (L 14 b) = rot red
- (L 15 a) = rot red
- (L 15 b) = rot red
- (L 16) = blau blue

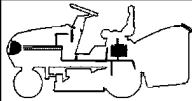

- L1 = weiß white
- L2 = rot red
- L3 = braun brown
- L4 = schwarz black

Technische Änderungen vorbehalten

22/22	RASENTRAKTOREN		ELEKTRIK 1 ELECTRIC 1 ELECTRIQUES 1	Crossover		 
2007	LAWN TRACTORS			74 / 13 - Art. 65053		
Rev073703	Tracteurs de pelouse			Modell 2007		
Bild Nr. REF.N° POS.N°	BEST.-NR. PART-N°. N° d. PIECE	BEZEICHNUNG	DESCRIPTION	DÉSIGNATION	Qty.	
1	A461285	ADAPTER FÜR KABELB TEC 13 HP+ 13 HP B&S	ADAPTER CABLE 3 HP B&S	ADAPTEUR CABLAGES	1	
2	A514246	KABELBAUM LICHT	CABLES ASSY.	ENS. CABLAGES POUR PHARES	1	
3	A514473	SICHERUNG 5A	FUSE 5A	FUSIBLE 5A	1	
4	A521353	DIODE 5A IN5408 T ET	DIODE 5A	DIODE 5A	1	
5	A521361	STARTERRELAIS 12V/100AMPER	STARTER RELAY	RELAIS D'ALL.	1	
6	A521362	KABELBAUM E-START 74/82	CABLES ASS.Y	ENS. CABLAGES	1	
7	A521363	KABEL ROT STARTER/RELAIS	CABLE RED	CABLES ROUGE	1	
8	A521365	KABEL BLAU MASSELEITER	CABLE BLUE	CABLES BLEU	1	
9	A521366	KABEL ROT BATTERIE/RELAIS	CABLE BATTERY-RELAIS	CABLES BATTERIE-RELAIS	1	

