

# SHINDAIWA SPECIAL TOOLS



## IMPORTANT!

This Special Tool Catalog is specifically designed for viewing on our Web site. The information described in this catalog may change without notice. If a printed copy is made, be sure to check the Web site periodically at [www.shindaiwa.com](http://www.shindaiwa.com) and verify you have the most current version by checking the part number shown at the bottom of this page.

## Table of Contents

Chain Saw Tools .....	3
Trimmer and Brushcutter Tools .....	13
Trimmer, Brushcutter, Blower, Hedge Trimmer, Edger and Pump Tools .....	19
Miscellaneous Tools .....	27
Hand Tools .....	28
Carburetor .....	30
Diagnostic .....	31
Adhesives/Lubricants .....	33
Technical Literature .....	35
Video .....	38
Appendix .....	38

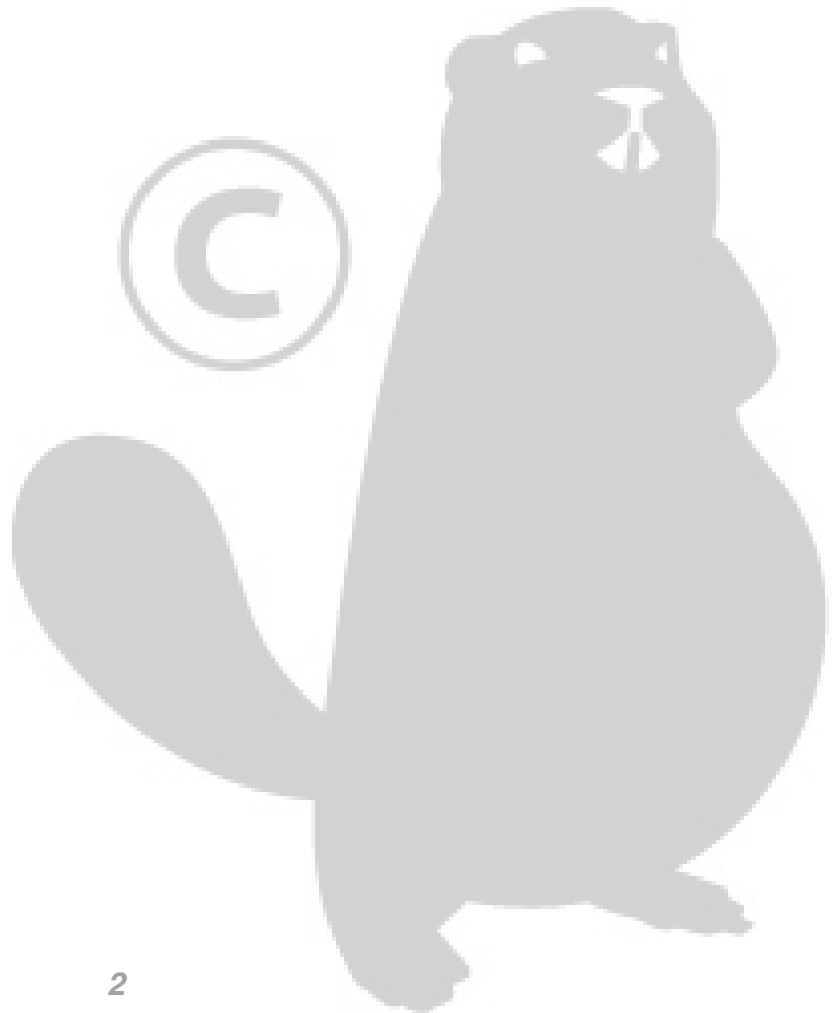

# CHAIN SAW TOOLS

Reference the Shindaiwa Chain Saw Service Manual (part number 60654) for proper repair procedures.

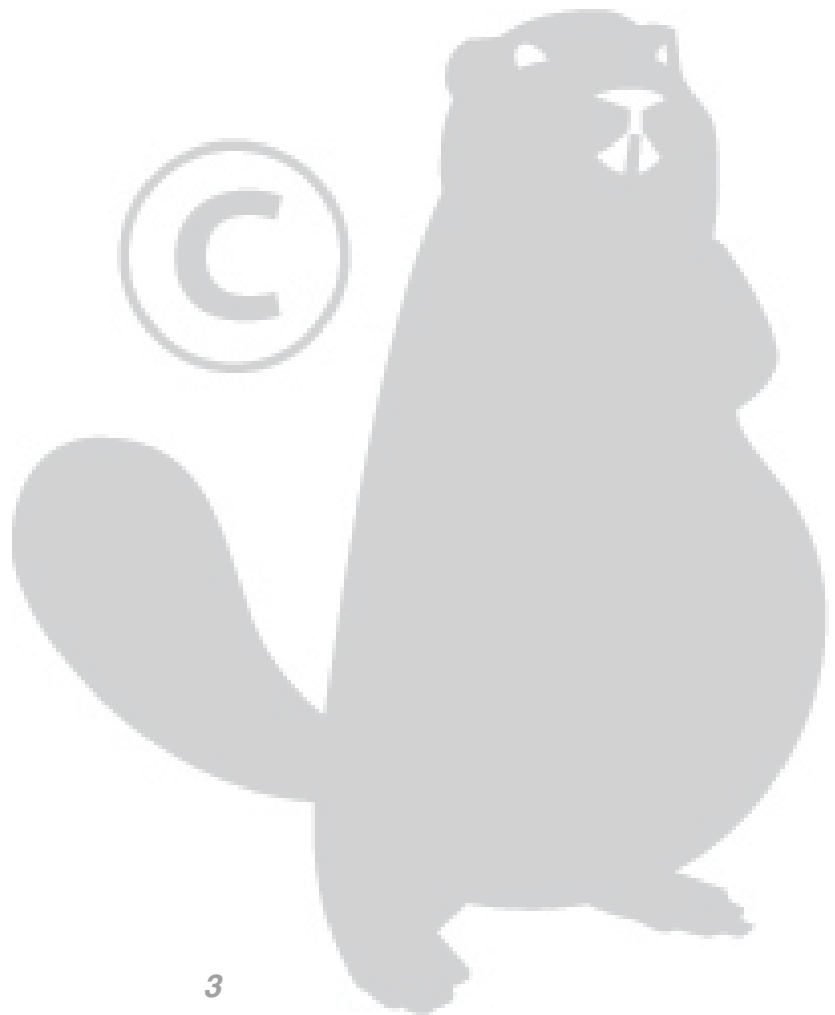

22154-96000  
300/300S, 360, 377 Tool Set

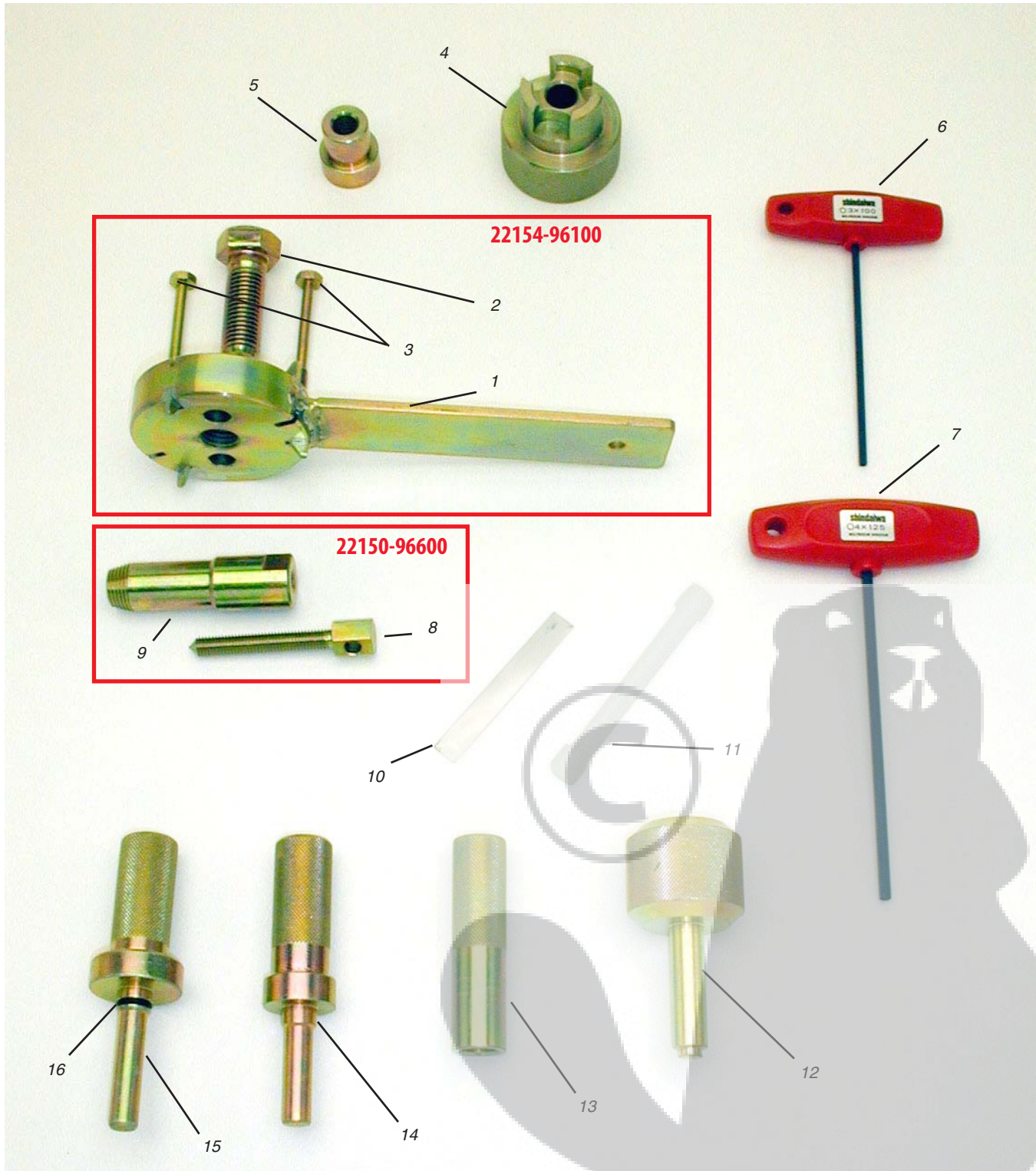

Index No.	Part Number Pieza No.	Part Name	Descripción	Nom de la pièce	Qty. Qty. Cant.
	<b>22154-96100</b>	<b>FLYWHEEL PULLER ASSEMBLY</b>	<b>EXTRACTOR, COMPLETO</b>	<b>EXTRACTEUR, COMPLET</b>	<b>1</b>
1	22154-96110	CLUTCH SHOE REMOVAL TOOL	EXTRACTOR	EXTRACTEUR	1
2	22100-96121	CENTER BOLT	PERNO	BOULON	1
3	22102-96130	BOLT	PERNO	BOULON	2
4	22154-96410	HOLDER M	SOPORTE M	SUPPORT M	1
5	22154-96220	SET GAUGE	CALIBRADOR DE HOJA	JAUGE D'ÉPAISSEUR	1
6	22155-96521	T-WRENCH, 3MM	LLAVE, 3MM	CLÉ, 3MM	1
7	22155-96531	T-WRENCH, 4MM	LLAVE, 4MM	CLÉ, 4MM	1
	<b>22150-96600</b>	<b>PULLER M ASSEMBLY</b>	<b>EXTRACTOR, M COMPLETO</b>	<b>EXTRACTEUR, M COMPLET</b>	<b>1</b>
8	22150-96620	BOLT (PULLER M)	PERNO	BOULON	1
9	22150-96610	PULLER M	EXTRACTOR, M	EXTRACTEUR, M	1
10	22154-96210	AIR GAP GAUGE (.012" - .014")	CALIBRADOR (.012" - .014")	JAUGE (.012" - .014")	1
11	22155-96240	PISTON STOP, NYLON	TRABADOR DE PISTON	BLOQUEUR DU PISTON	1
12	22154-96460	A/V INSTALLER	GUIA	GUIDE	1
13	22154-96440	SEAL DRIVER	INSTALADOR DE RETENEDORES	POUSOIR DE BAGUE	1
14	22154-96420	SEAL DRIVER	INSTALADOR DE RETENEDORES	POUSOIR DE BAGUE	1
15	22154-96430	BEARING DRIVER	INSTALADOR DE COJINETE	POUSOIR DE ROULEMENT	1
16	02301-01002	O-RING	EMPAQUE, TIPO "O"	JOINT TORIQUE	1

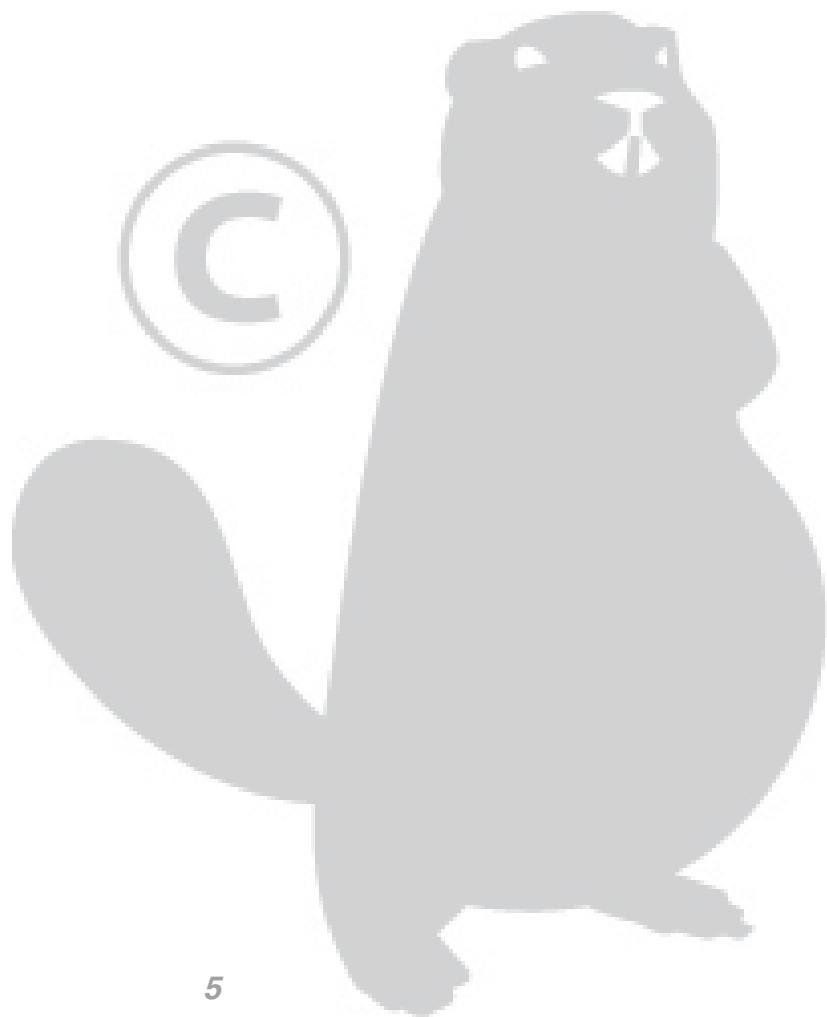

22160-96000  
488 Tool Set

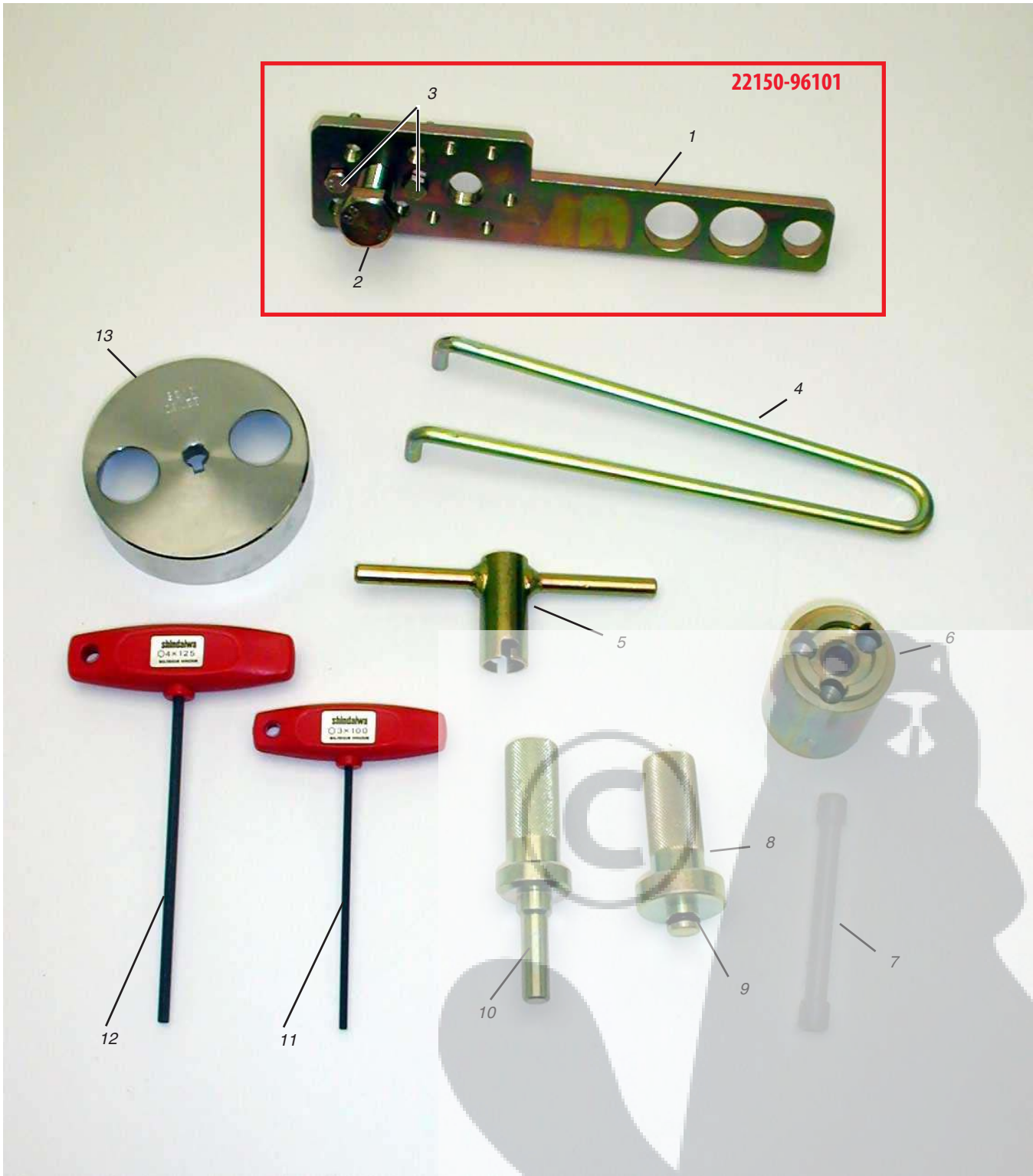

22150-96101

<b>Index No.</b>	<b>Part Number</b>	<b>Part Name</b>	<b>Descripcion</b>	<b>Nom de la piece</b>	<b>Qty. Qty. Cant.</b>
<b>Indice</b>	<b>Numero</b>				
	<b>22150-96101</b>	<b>FLYWHEEL PULLER ASSEMBLY</b>	<b>EXTRACTOR, COMPLETO</b>	<b>EXTRACTEUR, COMPLET</b>	<b>1</b>
1	20000-96114	LEVER	PALANCA	LEVIER	1
2	22100-96121	CENTER BOLT	PERNO	BOULON	1
3	22102-96130	BOLT	PERNO	BOULON	2
4	22160-96250	SPANNER WRENCH	LLAVE DE GANCHO	CLÉ	1
5	22150-96510	CHAIN BREAK SPRING WRENCH	LLAVE, FRENO RESORTE	CL,É RESSORT DE FREIN	1
6	22160-96410	HOLDER	SOPORTE	SUPPORT	1
7	22155-96240	PISTON STOP, NYLON	TRABADOR DE PISTON	BLOQUEUR DU PISTON	1
8	22160-96440	ROD 6201	VARILLA	TIGE	1
9	02301-01002	O-RING	EMPAQUE, TIPO "O"	JOINT TORIQUE	1
10	22155-96420	SEAL DRIVER M	INSTALADOR DE RETENEDORES	POUSOIR DE BAGUE	1
11	22155-96521	T-WRENCH (3MM)	LLAVE (3MM)	CLÉ (3MM)	1
12	22155-96531	T-WRENCH (4MM)	LLAVE (4MM)	CLÉ (4MM)	1
13	22160-96210	SET GAUGE (.012"-.014")	CALIBRADOR (.012"-.014")	JAUGE (.012"-.014")	1

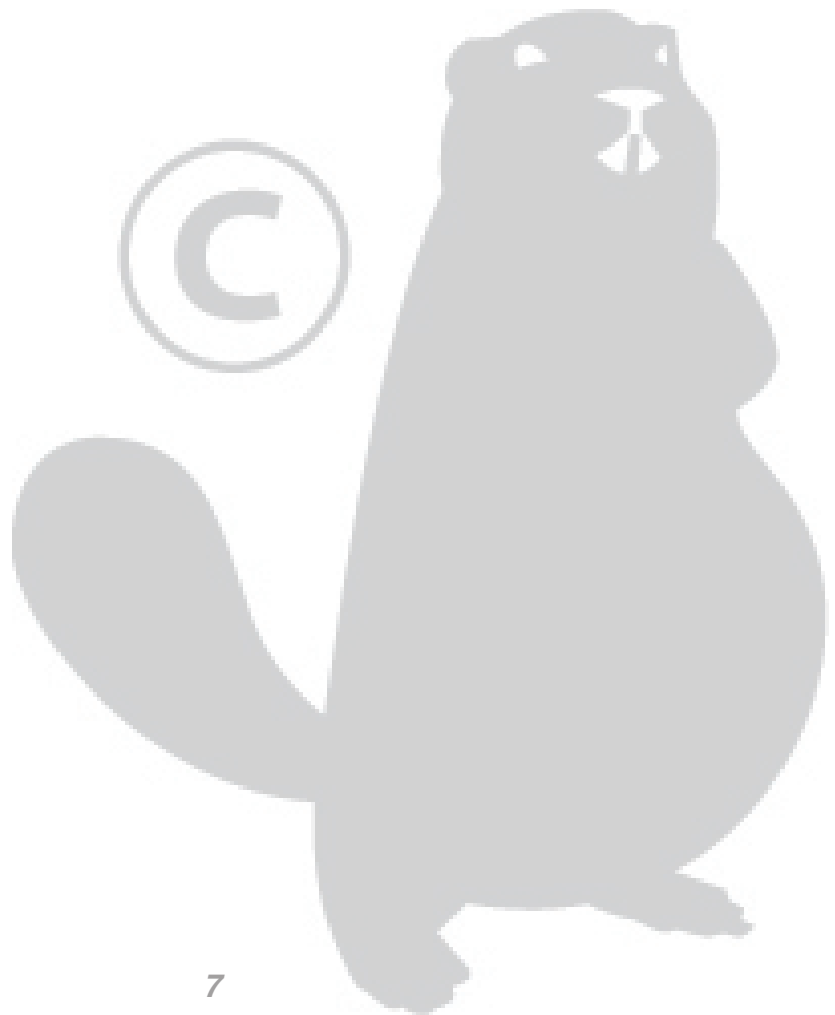

# Chain Saw Tool Kit

72282-96000  
575/577, 695 Tool Set

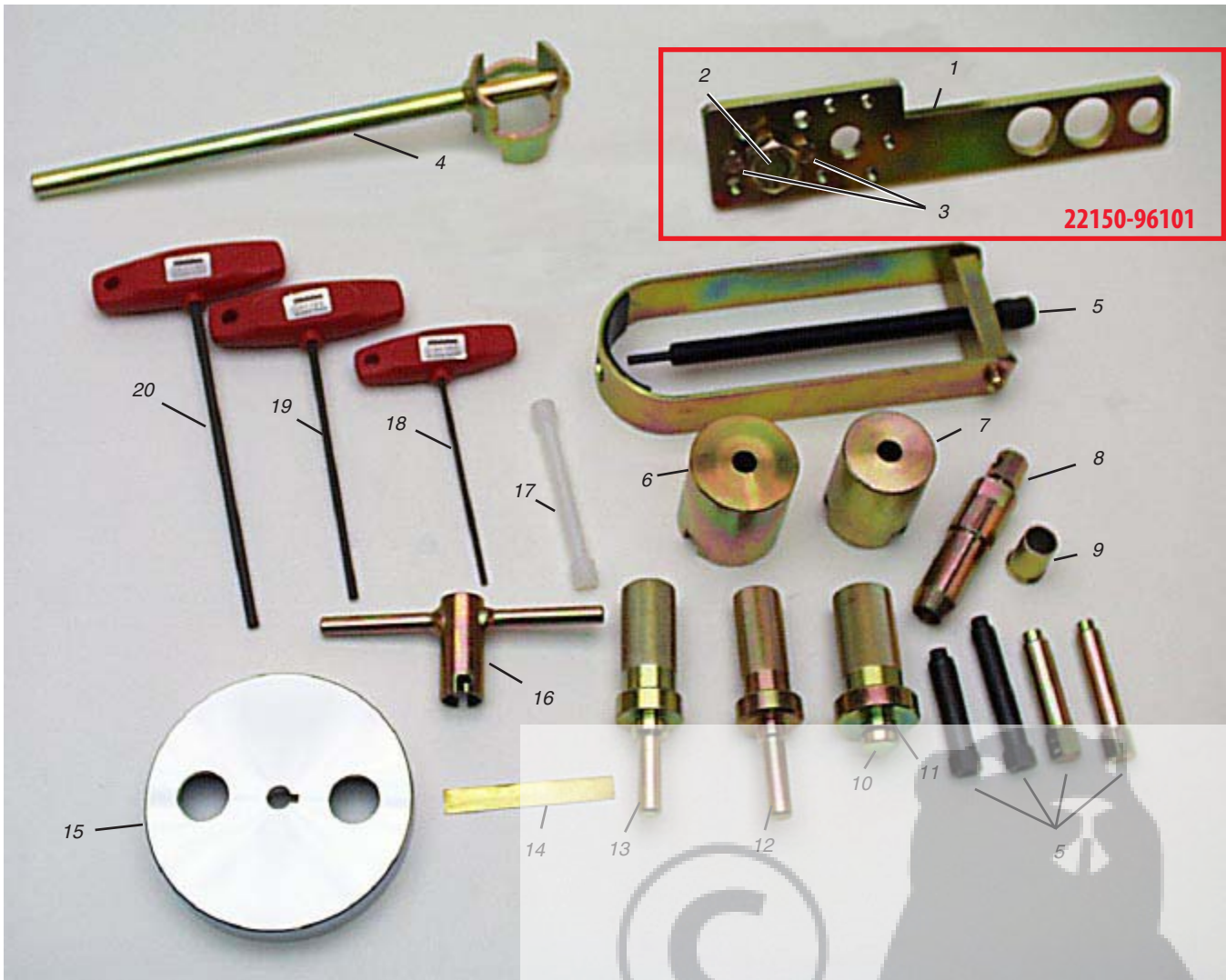



<b>Index No.</b>	<b>Part Number</b>	<b>Part Name</b>	<b>Descripcion</b>	<b>Nom de la piece</b>	<b>Qty. Qty. Cant.</b>
	<b>22150-96101</b>	<b>FLYWHEEL PULLER</b>	<b>EXTRACTOR, COMPLETO</b>	<b>EXTRACTEUR, COMPLET</b>	<b>1</b>
1	20000-96114	LEVER	PALANCA	LEVIER	1
2	22100-96121	CENTER BOLT	PERNO	BOULON	1
3	22102-96130	BOLT	PERNO	BOULON	2
4	22155-91580	CLUTCH SHOE TOOL	EXTRACTOR	EXTRACTEUR	1
5	72282-96300	PISTON PULLER SET	EXTRACTOR , PISTON	EXTRACTEUR DE PISTON	1
6	22150-96440	HOLDER C	SOPORTE C	SUPPORT C	1
7	22150-96410	HOLDER M	SOPORTE M	SUPPORT M	1
8	22150-96600	PULLER ASSEMBLY M	EXTRACTOR, M COMPLETO	EXTRACTEUR, M COMPLET	1
9	22150-96460	COLLAR, OIL SEAL	COLLAR	COLLET	1
10	22150-96430	BEARING DRIVER	INSTALADOR DE COJINETE	POUSOIR DE ROULEMENT	1
11	02301-01002	O-RING	EMPAQUE, TIPO "O"	JOINT TORIQUE	1
12	22150-96420	SEAL DRIVER M	INSTALADOR DE RETENEDORES M	POUSOIR DE BAGUE M	1
13	22150-96450	SEAL DRIVER C	INSTALADOR DE RETENEDORES C	POUSOIR DE BAGUE C	1
14	22155-96220	AIR GAP GAUGE	CALIBRADOR	JAUGE	1
15	22155-96210	SET GAUGE (.018-.020)	CALIBRADOR (.018-.020)	JAUGE (.018-.020)	1
16	22150-96510	CHAIN BREAK SPRING WRENCH	LLAVE, FRENO RESORTE	CL,É RESSORT DE FREIN	1
17	22155-96240	PISTON STOP	TRABADOR DE PISTON	BLOQUEUR DU PISTON	1
18	22155-96521	T-WRENCH, 3MM	LLAVE (3MM)	CLÉ (3MM)	1
19	22155-96531	T-WRENCH, 4MM	LLAVE (4MM)	CLÉ (4MM)	1
20	22155-96540	T-WRENCH, 5MM	LLAVE (5MM)	CLÉ (5MM)	1

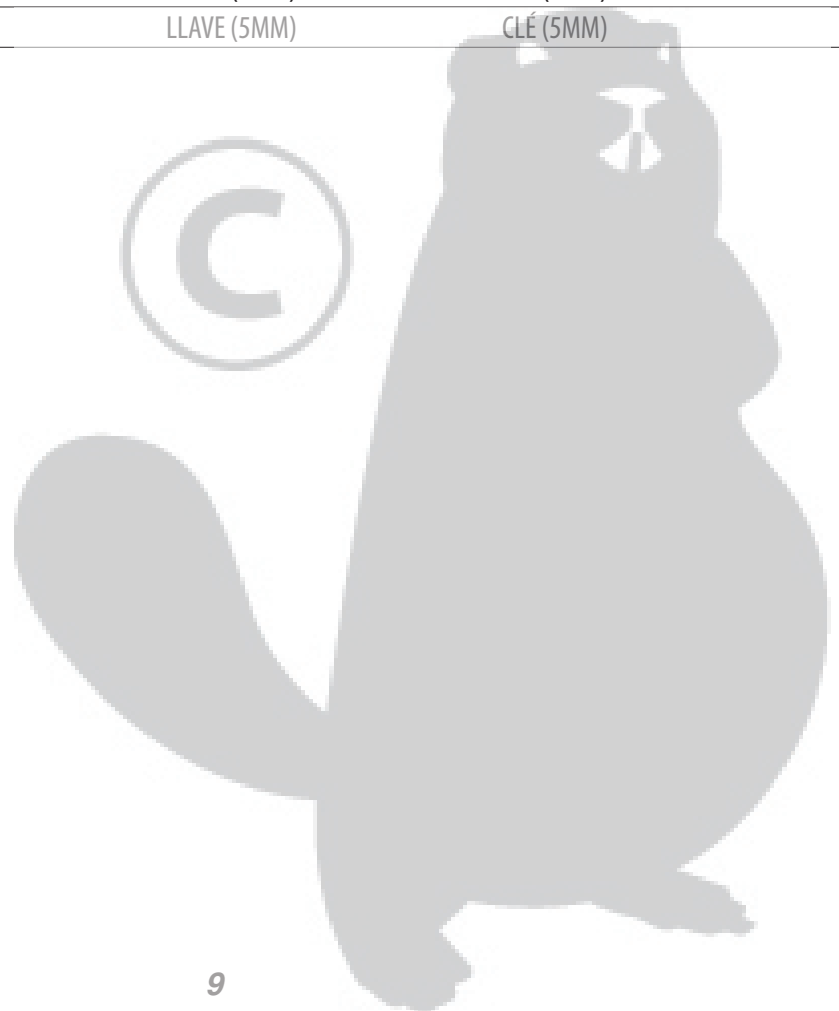

80463  
757 Tool Set

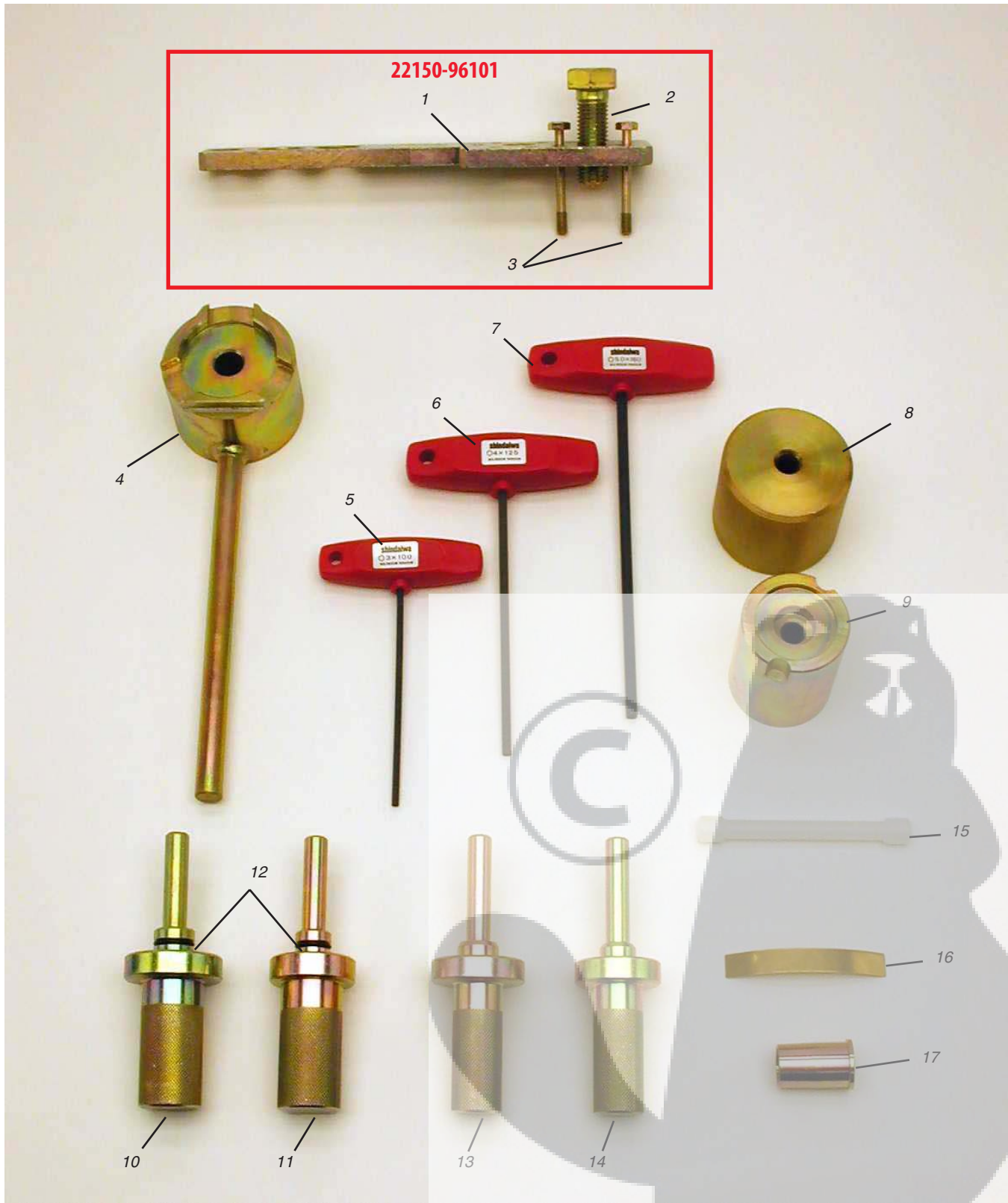

<b>Index No.</b>	<b>Part Number</b>	<b>Part Name</b>	<b>Descripcion</b>	<b>Nom de la piece</b>	<b>Qty. Qty. Cant.</b>
<b>Indice</b>	<b>Numero</b>				
	<b>22150-96101</b>	<b>FLYWHEEL PULLER ASSY.</b>	<b>EXTRACTOR, COMPLETO</b>	<b>EXTRACTEUR, COMPLET</b>	<b>1</b>
1	20000-96114	LEVER	PALANCA	LEVIER	1
2	22100-96121	CENTER BOLT	PERNO	BOULON	1
3	22102-96130	BOLT	PERNO	BOULON	2
4	22169-96580	CLUTCH REMOVAL TOOL	EXTRACTOR	EXTRACTEUR	1
5	22155-96521	T-WRENCH (3MM)	LLAVE, 3MM	CLÉ, 3MM	1
6	22155-96531	T-WRENCH (4MM)	LLAVE, 4MM	CLÉ, 4MM	1
7	22155-96540	T-WRENCH (5MM)	LLAVE, 5MM	CLÉ, 5MM	1
8	22169-96410	HOLDER, M	SOPORTE M	SUPPORT M	1
9	22169-96440	HOLDER, C	SOPORTE C	SUPPORT C	1
10	22169-96430	ROD 6202	VARILLA 6202	TIGE 6202	1
11	22169-96470	ROD 6203	VARILLA 6203	TIGE 6203	1
12	02301-01002	O-RING	EMPAQUE, TIPO "O"	JOINT TORIQUE	2
13	22169-96450	SEAL DRIVER	NSTALADOR DE RETENEDORES	POUSOIR DE BAGUE	1
14	22169-96420	SEAL DRIVER	NSTALADOR DE RETENEDORES	POUSOIR DE BAGUE	1
15	22155-96240	PISTON STOP, NYLON	TRABADOR DE PISTON	BLOQUEUR DU PISTON	1
16	22155-96220	AIR GAP GAUGE (.018-.020)	CALIBRADOR (.018-.020)	JAUGE (.018-.020)	1
17	22169-96460	COLLAR, OIL SEAL	COLLAR	COLLET	1

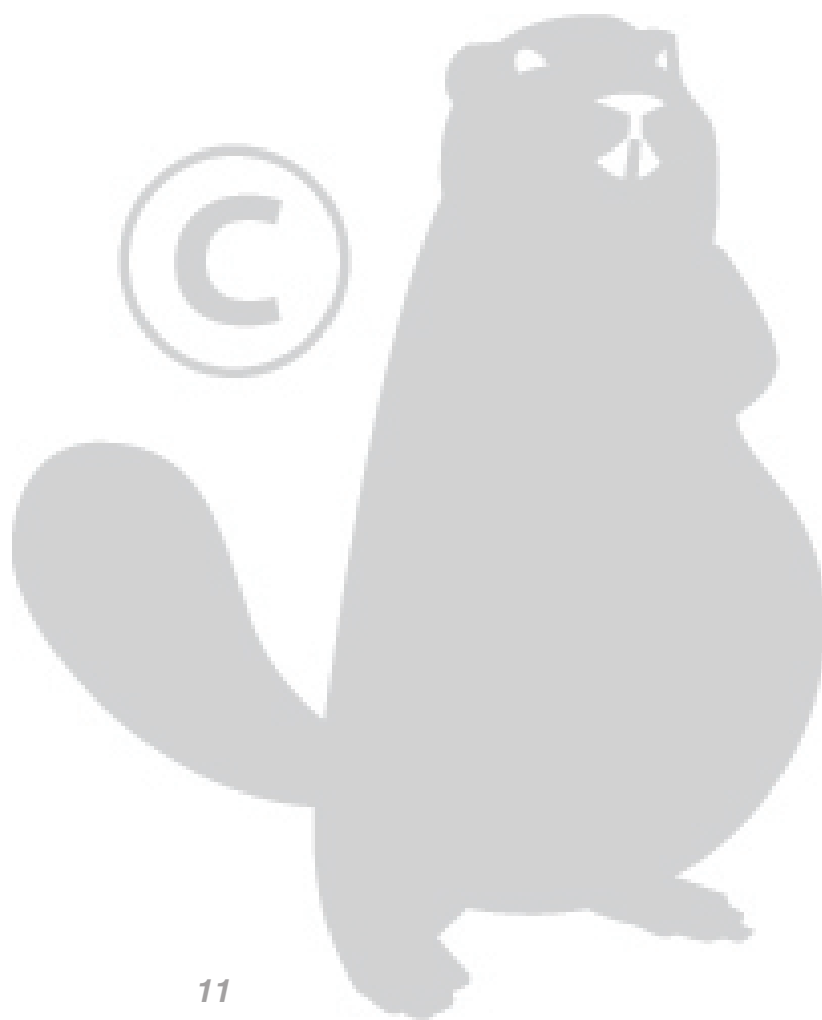

## Miscellaneous Chain Saw Tools

### 451, 500, EC350

Please reference the Horizontal Cylinder Chain Saw Service Manual (Part number 10065-5) for additional service related information for these saws.

**.012"-.014"**



22102-96211 Set Gauge



22102-96530 Set Pin



22100-96410 Stopper

## Chain Saw Tools, All

**72282-96300**

### Piston Puller Assembly

Reference the Shindaiwa Chain Saw Service Manual (part number 60654) Section 7, for proper repair procedures.



Index No. Indice	Part Number Pieza No. Numero	Part Name	Descripcion	Nom de la piece	Qty. Qty. Cant.
	<b>72282-96300</b>	<b>PISTON PULLER ASSY.</b>	<b>EXTRACTOR , PISTON</b>	<b>EXTRACTEUR DE PISTON</b>	<b>1</b>
1	22155-96310	PULLER	EXTRACTOR	EXTRACTEUR	1
2	22155-96340	BOLT	PERNO	BOULON	1
3	22155-96320	BOSS	REFUERZO	AXE	1
4	11204-06120	SCREW	SALIENTE	MOYEU	2
5	22155-96360	GUIDE PIN	PASADOR	GUIDE DE L'AXE	1
6	22150-96360	GUIDE PIN	PASADOR	GUIDE DE L'AXE	1
7	22155-96350	PIN ADAPTER	PASADOR ADAPTADOR	ADAPTATEUR D'AXE	1
8	22150-96350	PIN ADAPTER	PASADOR ADAPTADOR	ADAPTATEUR D'AXE	1

# TRIMMER & BRUSHCUTTER TOOLS

Reference the Shindaiwa Trimmer, Brushcutter Service Manual (part number 60506) for proper repair procedures.

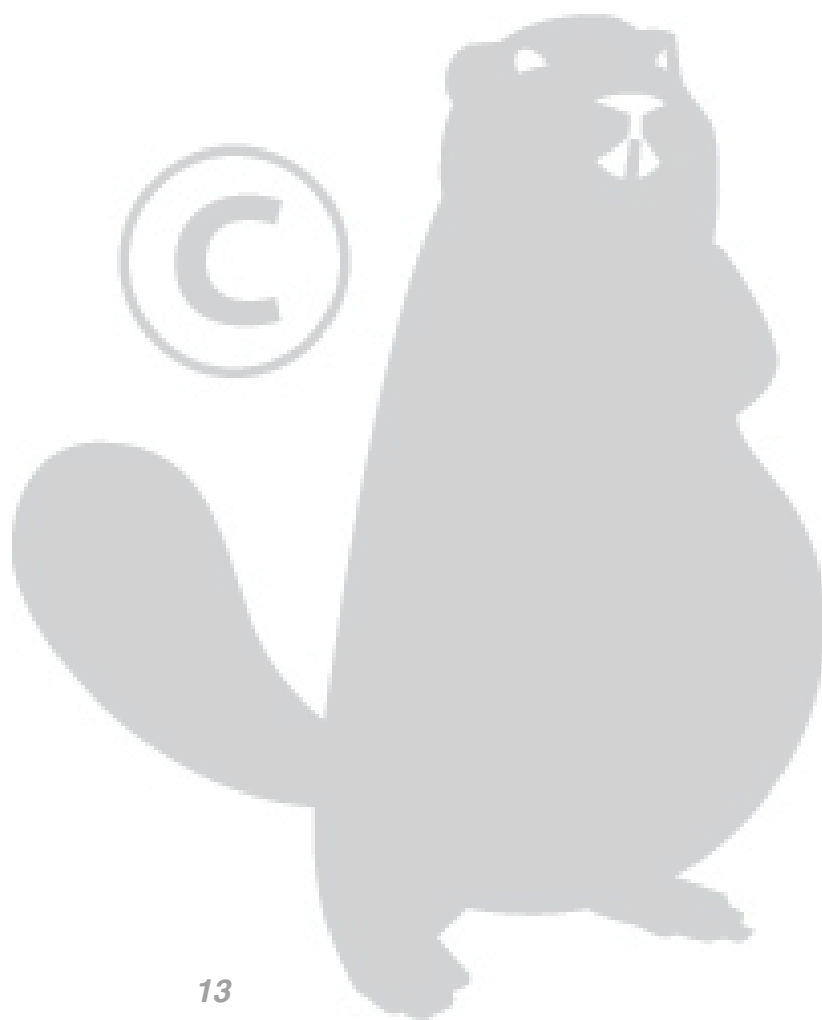

# TRIMMERS & BRUSHCUTTERS

22035-96001

Lower Unit Tool Set - Small (7mm) - Fits T18, T20, T/C230, T2500, 65001  
Trimmer Tool

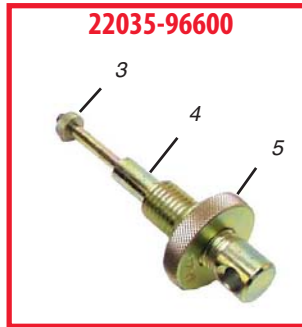

# TRIMMERS & BRUSHCUTTERS

80464

Lower Unit Tool Set - (8mm) - Fits T/C250\*, T/C260

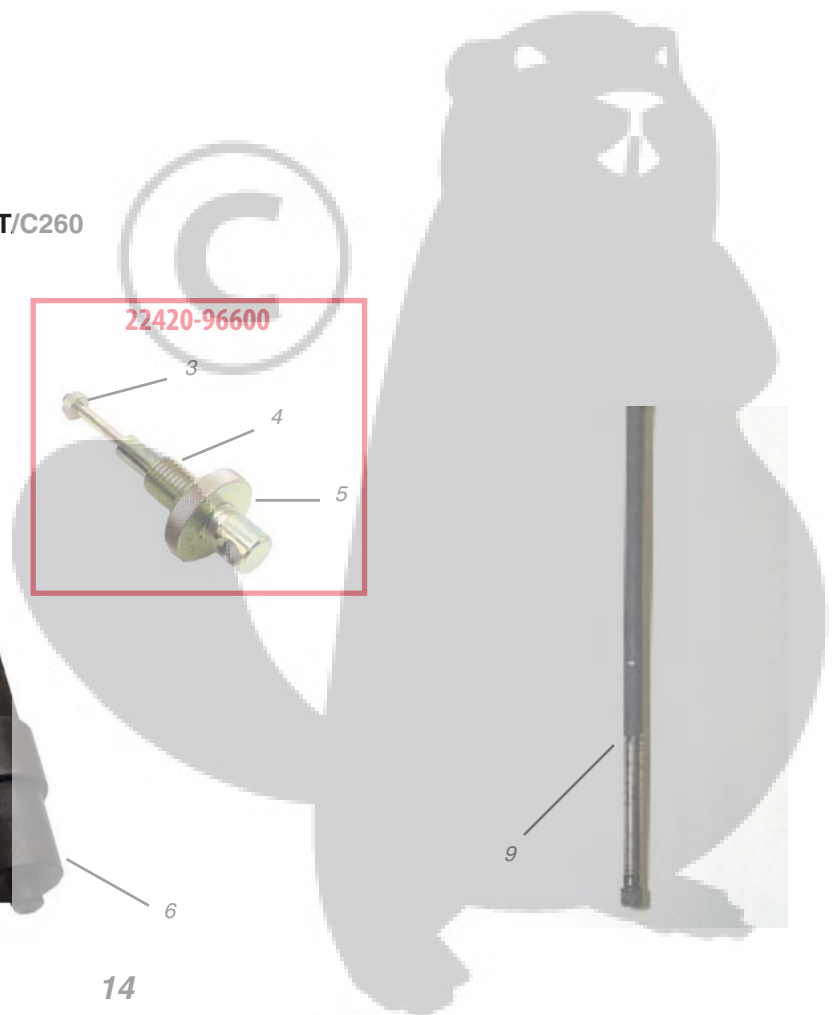
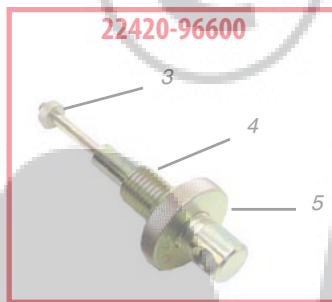

<b>Index No.</b>	<b>Part Number</b>	<b>Part Name</b>	<b>Descripcion</b>	<b>Nom de la piece</b>	<b>Qty. Qty. Cant.</b>
<b>Indice</b>	<b>Numero</b>				
	<b>22035-96500</b>	<b>PULLER ASSY.</b>	<b>EXTRACTOR, COMPLETO</b>	<b>EXTRACTEUR, COMPLET</b>	<b>1</b>
1	22035-96520	BOLT, 7MM, LH	PERNO, 7MM, LH	BOULON, 7MM, LH	1
2	22035-96510	HOLDER	SOPORTE	SUPPORT	1
	<b>22035-96600</b>	<b>PULLER ASSY.</b>	<b>EXTRACTOR, COMPLETO</b>	<b>EXTRACTEUR, COMPLET</b>	<b>1</b>
3	22000-96630	NUT	TUERCA	ÉCROU	1
4	22000-96621	BOLT	PERNO	BOULON	1
5	22035-96610	HOLDER	SOPORTE	SUPPORT	1
6	22035-96310	BEARING DRIVER	INSTALADOR DE COJINETE	POUSSOIR DE ROULEMENT	1
7	22035-96210	BEARING DRIVER	INSTALADOR DE COJINETE	POUSSOIR DE ROULEMENT	1
8	22035-96410	BEARING DRIVER	INSTALADOR DE COJINETE	POUSSOIR DE ROULEMENT	1
9	22000-96101	BUSHING DRIVER*	INSTALADOR DE BUJE	POUSSOIR DE BAGUE	1

<b>Index No.</b>	<b>Part Number</b>	<b>Part Name</b>	<b>Descripcion</b>	<b>Nom de la piece</b>	<b>Qty. Qty. Cant.</b>
<b>Indice</b>	<b>Numero</b>				
	<b>22420-96500</b>	<b>PULLER ASSY.</b>	<b>EXTRACTOR, COMPLETO</b>	<b>EXTRACTEUR, COMPLET</b>	<b>1</b>
1	22000-96521	BOLT, 8MM, LH	PERNO, 8MM, LH	BOULON, 8MM, LH	1
2	22035-96510	HOLDER	SOPORTE	SUPPORT	1
	<b>22420-96600</b>	<b>PULLER ASSY.</b>	<b>EXTRACTOR, COMPLETO</b>	<b>EXTRACTEUR, COMPLET</b>	<b>1</b>
3	22000-96630	NUT	TUERCA	ÉCROU	1
4	22000-96621	BOLT	PERNO	BOULON	1
5	22000-96610	HOLDER	SOPORTE	SUPPORT	1
6	22420-96210	BEARING DRIVER	INSTALADOR DE COJINETE	POUSSOIR DE ROULEMENT	1
7	22420-96310	BEARING DRIVER	INSTALADOR DE COJINETE	POUSSOIR DE ROULEMENT	1
8	22420-96410	BEARING DRIVER	INSTALADOR DE COJINETE	POUSSOIR DE ROULEMENT	1
9	22000-96101	BUSHING DRIVER**	INSTALADOR DE BUJE	POUSSOIR DE BAGUE	1

\*For T/C250 and Lawn Edger gearcase repair procedure, please see Section 11 and SB-41 for service information

# TRIMMERS & BRUSHCUTTERS

22000-96003

Lower Unit Tool Set - Medium (8mm) - Fits T/C25, T/C27, T/C270, BP35, T350

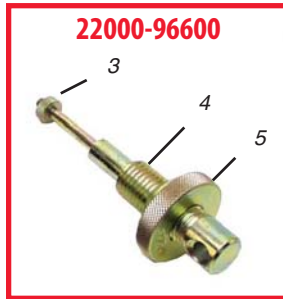
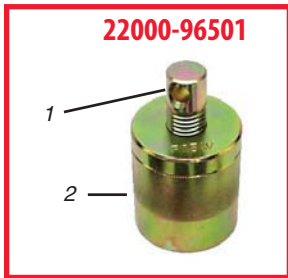

# TRIMMERS & BRUSHCUTTERS

22015-96001

Lower Unit Tool Set - Large (10mm) - Fits C35, C350, B40, B45, B450, RC45, B530

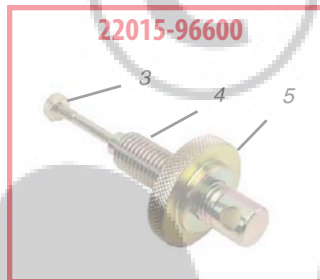



<b>Index No.</b>	<b>Part Number</b>	<b>Part Name</b>	<b>Descripcion</b>	<b>Nom de la piece</b>	<b>Qty. Qty. Cant.</b>
	<b>22000-96501</b>	<b>PULLER ASSY.</b>	<b>EXTRACTOR, COMPLETO</b>	<b>EXTRACTEUR, COMPLET</b>	<b>1</b>
1	22000-96521	BOLT, 8MM, LH	PERNO, 8MM, LH	BOULON, 8MM, LH	1
2	22000-96510	HOLDER	SOPORTE	SUPPORT	1
	<b>22000-96600</b>	<b>PULLER ASSY.</b>	<b>EXTRACTOR, COMPLETO</b>	<b>EXTRACTEUR, COMPLET</b>	<b>1</b>
3	22000-96630	NUT	TUERCA	ÉCROU	1
4	22000-96621	BOLT	PERNO	BOULON	1
5	22000-96610	HOLDER	SOPORTE	SUPPORT	1
6	22000-96210	BEARING DRIVER	INSTALADOR DE COJINETE	POUSSOIR DE ROULEMENT	1
7	22000-96310	BEARING DRIVER	INSTALADOR DE COJINETE	POUSSOIR DE ROULEMENT	1
8	22000-96410	BEARING DRIVER	INSTALADOR DE COJINETE	POUSSOIR DE ROULEMENT	1
9	22000-96101	BUSHING DRIVER**	NSTALADOR DE BUJE	POUSSOIR DE BAGUE	1

<b>Index No.</b>	<b>Part Number</b>	<b>Part Name</b>	<b>Descripcion</b>	<b>Nom de la piece</b>	<b>Qty. Qty. Cant.</b>
	<b>22015-96500</b>	<b>PULLER ASSY.</b>	<b>EXTRACTOR, COMPLETO</b>	<b>EXTRACTEUR, COMPLET</b>	<b>1</b>
1	22015-96520	BOLT, 10MM, LH	PERNO, 10 MM, LH	BOULON, 10 MM, LH	1
2	22015-96510	HOLDER	SOPORTE	SUPPORT	1
	<b>22015-96600</b>	<b>PULLER ASSY.</b>	<b>EXTRACTOR, COMPLETO</b>	<b>EXTRACTEUR, COMPLET</b>	<b>1</b>
3	22000-96630	NUT	TUERCA	ÉCROU	1
4	22000-96621	BOLT	PERNO	BOULON	1
5	22015-96610	HOLDER	SOPORTE	SUPPORT	1
6	22015-96310	BEARING DRIVER	INSTALADOR DE COJINETE	POUSSOIR DE ROULEMENT	1
7	22015-96210	BEARING DRIVER	INSTALADOR DE COJINETE	POUSSOIR DE ROULEMENT	1
8	22015-96410	BEARING DRIVER	INSTALADOR DE COJINETE	POUSSOIR DE ROULEMENT	1
9	22000-96101	BUSHING DRIVER*	NSTALADOR DE BUJE	POUSSOIR DE BAGUE	1

# **Trimmer, Brushcutter, Blower, Hedge Trimmer, Edger and Pump Tools**

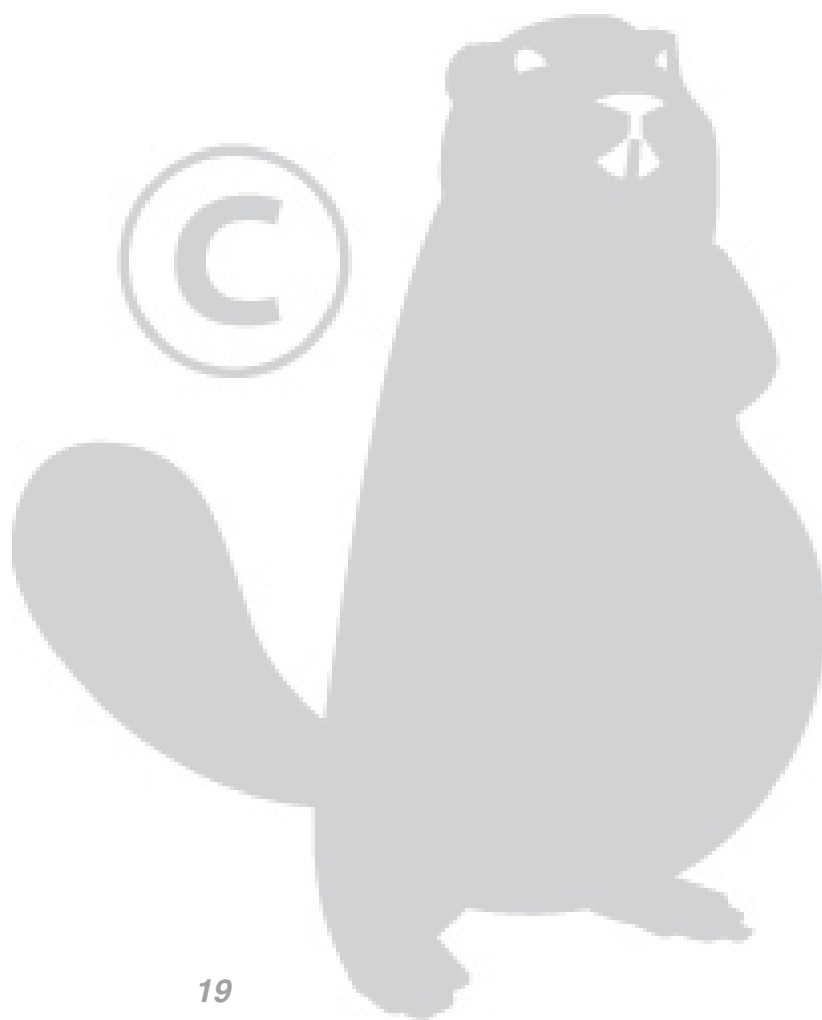

20000-96104

Flywheel Puller Assembly

Note: Add 2 ea. bolts (22102-96130) to make "universal" kit for chainsaws too.

Reference the Shindaiwa Trimmer, Brushcutter Service Manual (part number 60506) Section 6 for proper repair procedures.

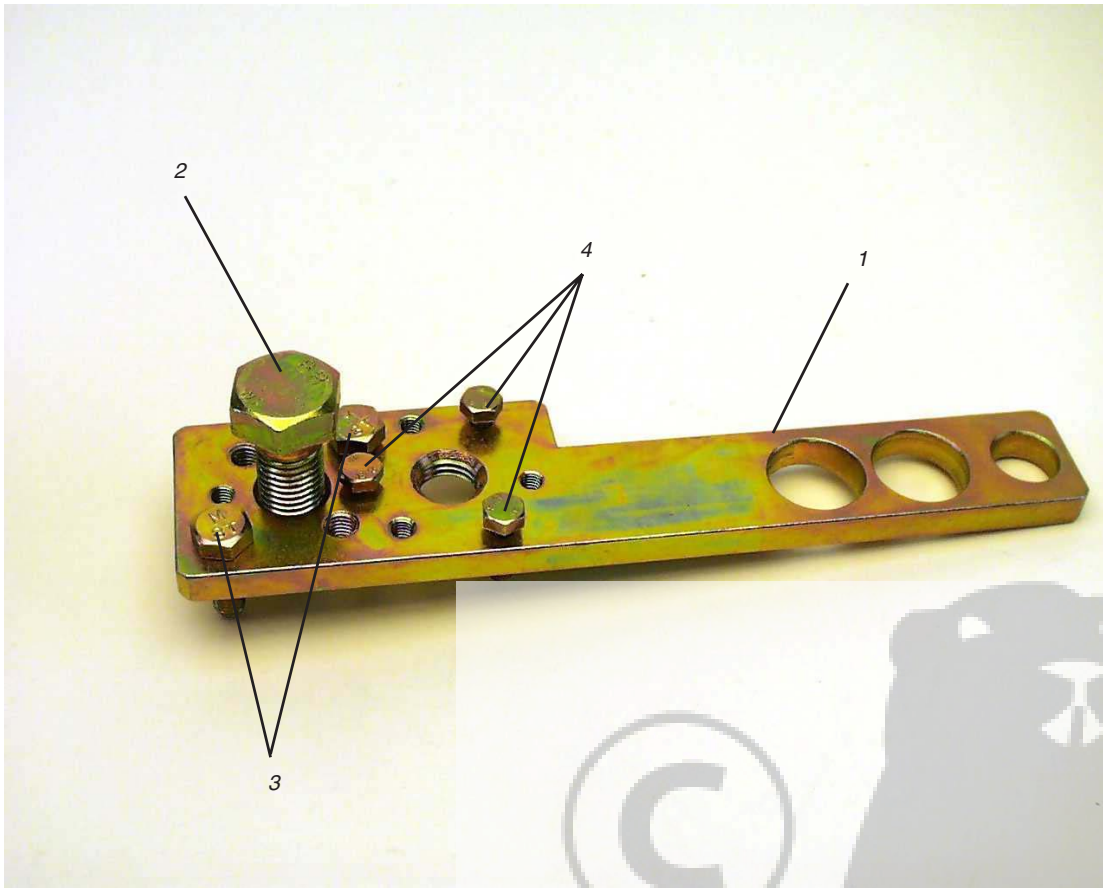

Index No. Indice	Part Number Pieza No. Numero	Part Name	Descripcion	Nom de la piece	Qty. Qty. Cant.
	<b>20000-96104</b>	<b>FLYWHEEL PULLER ASSEMBLY</b>	<b>EXTRACTOR, COMPLETO</b>	<b>EXTRACTEUR, COMPLET</b>	<b>1</b>
1	20000-96114	LEVER	PALANCA	LEVIER	1
2	22100-96121	CENTER BOLT	PERNO	BOULON	1
3	20000-96140	BOLT	PERNO	BOULON	2
4	20000-96130	BOLT	PERNO	BOULON	3

Reference the Shindaiwa Trimmer, Brushcutter Service Manual (part number 60506) procedures.

Section 11 for proper repair



Index No. Indice	Part Number Pieza No. Numero	Part Name	Descripcion	Nom de la piece	Qty. Qty. Cant.
1	20000-96104	Flywheel Puller Assembly	EXTRACTOR, COMPLETO	EXTRACTEUR, COMPLET	1
2	20021-96601	PISTON PULLER ASSEMBLY	EXTRACTOR, PISTON	EXTRACTEUR DE PISTON	1
3	20021-96420	STOPPER (2) [FOR HT20 ONLY]	SUJETADOR	ARRÊT	1
4	20000-96411	FLYWHEEL SPANNER	LLAVE DE GANCHO	CLÉ	1
5	20000-96210	AIR GAP GAUGE (.012"-.014")	CALIBRADOR (.012" - .014")	JAUGE (.012" - .014")	1

20021-96601

**Piston Puller Assembly**

Reference the Shindaiwa Trimmer, Brushcutter Service Manual (part number 60506) Section 7 for proper repair procedures.



Index No. Indice	Part Number Pieza No. Numero	Part Name	Descripcion	Nom de la piece	Qty. Qty. Cant.
1	20021-96611	PULLER	EXTRACTOR	EXTRACTEUR	1
2	20021-96621	BOLT	PERNO	BOULON	1
3	01211-06120	SCREW	SALIENTE	MOYEU	2
4	20000-96640	BOSS	REFUERZO	AXE	1
5	20000-96631	GUIDE PIN	PASADOR	GUIDE DE L'AXE	1
6	20035-96630	GUIDE PIN	PASADOR	GUIDE DE L'AXE	1
7	20021-96630	GUIDE PIN	PASADOR	GUIDE DE L'AXE	1
8	20021-96660	PIN ADAPTER	PASADOR ADAPTADOR	ADAPTATEUR D'AXE	1
9	20021-96650	PIN ADAPTER	PASADOR ADAPTADOR	ADAPTATEUR D'AXE	1
10	20021-96670	PIN ADAPTER	PASADOR ADAPTADOR	ADAPTATEUR D'AXE	1

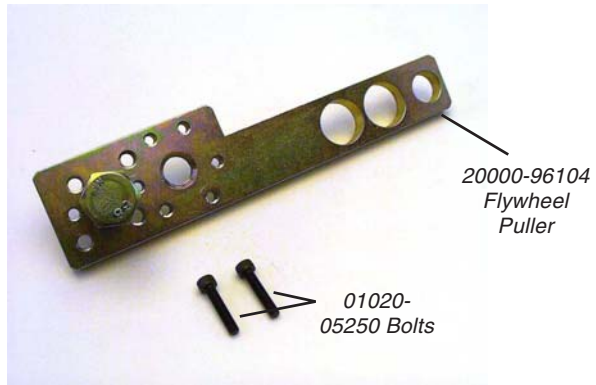

To pull the EB240 flywheel, use the flywheel puller (20000-96104) along with two separate Allen bolts (01020-05250) and remove the flywheel as shown above.

# HEDGE TRIMMERS

---

Reference the HT/DH230 Gearcase Service Manual (part number 61305-1) for proper repair procedures



**99909-20230**

**Clutch Drum Removal Tool - HT/DH230 only**

See Section 7, page 17 for proper removal procedure



**20870-98050**

**Connecting Rod Bearing Retainer  
HT230, DH230**



**22910-96210**

**Stopper - HT20 only**

For locking the connecting rods



**22910-96101**

**Clutch Drum Removal Tool - HT20 only**



**22910-96000**

**Optional Tool Kit - HT20 only**



**20000-96411**

**Flywheel Spanner - HT20**  
This part also fits all trimmers and  
brushcutters except T/C27 and T/C270

# HEDGE TRIMMERS

---

Reference the HT/DH230 Gearcase Service Manual (part number 61305-1) for proper repair procedures



**20000-96210**  
**Air Gap Gauge**



**20021-96420**  
Stopper - HT20

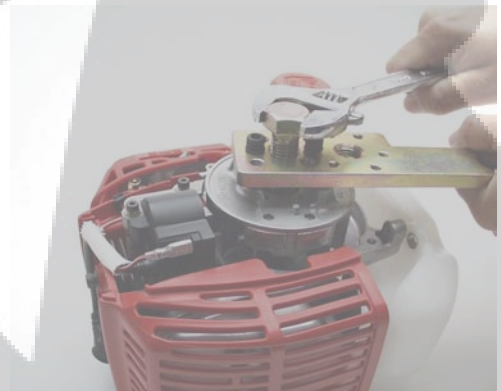
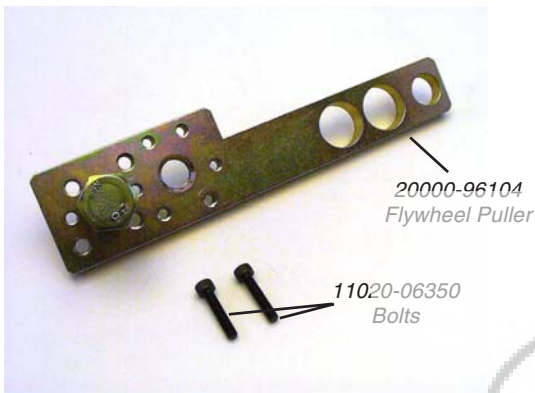

To pull the HT/DH230 flywheel, use the flywheel puller (20000-96104) along with two separate socket-head cap screws (11020-06350) and remove the flywheel as shown above.





**Spanner Wrenches**



**22580-91180  
Spark Plug Wrench  
(13x16mm T2500)**



**Spark Plug Wrench**



**T-Wrench**

Easy to use Allen wrenches for the Shindaiwa product line



**22155-96240  
Nylon Piston Stop**

Use this to lock the piston and crankshaft in position to facilitate clutch or recoil hub removal and installation. The nylon material reduces the chance of damage to the piston and cylinder ports. See the Trimmer and Brushcutter Service Manual (p/n 60506) Section 6, page 59 for proper usage

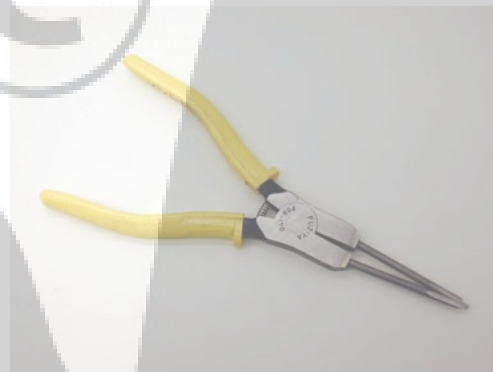

**22440-97020  
Snap Ring Pliers**

Use these pliers to reach the snap rings found to retain the clutch drum in the fan cover.

**HAND TOOLS**

---



**22150-91160**  
Carburetor Screw Driver



**22100-91150**  
Combination Screw Driver



**22150-91570**  
Spanner



**60880-98030**  
P230 Drive Sprocket Wrench

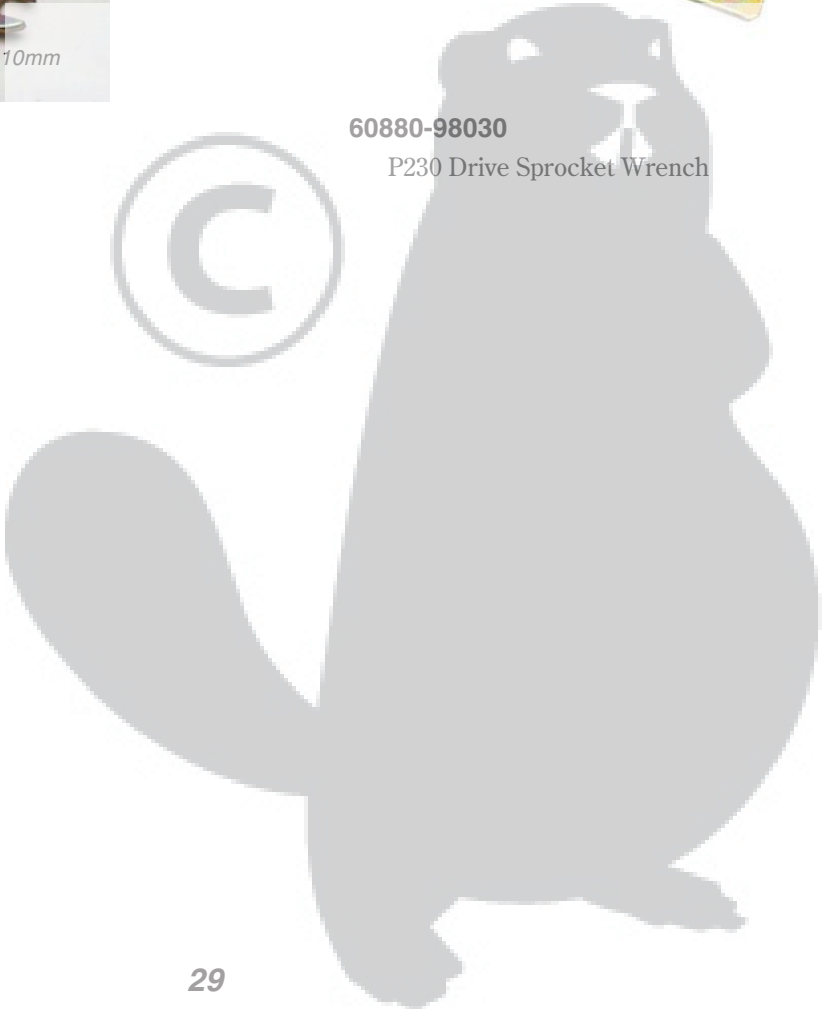

# CARBURETOR



**400-808**

Walbro Limiter Cap Kit  
for EPA/CARB Walbro carburetors only



**500-20**

Walbro Limiter Cap Removal Tool  
for EPA/CARB Walbro carburetors only



**500-500**

Walbro Tool Kit



**400-807**

Walbro Altitude Jet Kit

Jet sizes range from .036mm to .060 mm



**500-13**

Walbro Lever Gauge

Custom tool eases checking the height of the metering lever on Walbro carburetors. Reference Chainsaw Service Manual (p/n 60654) Section 3, page 33 for proper measuring procedures



**PET-2000DX**  
**Tachometer**

A small, light weight and reliable tachometer with a liquid crystal display, +/- 100 rpm accuracy and 2000 hour battery life. 40x60x15mm, 36 g



**80262**  
**Spark Plug Tester**

This non-adjustable tester is used to determine a plug's available spark. Neon lamp blinks if ignition is functioning. Will not affect coil output voltage.

(See the Chain Saw Service Manual (p/n 60654) Section 5, page 50 for proper testing procedures)



**99909-93**  
**Walbro Carburetor Pressure Tester**

Durable Walbro carburetor pressure tester is designed with a rebuildable aluminum plunger-type pump. Useful in performing a wide variety of carburetor and other fuel system related testing and troubleshooting.

(Reference the Chain Saw Service Manual (p/n 60654) Section 2, page 14 and Section 3, page 39 for proper testing procedures)



**72174-99200**  
**Crankcase Pressure Tester Kit**

Many units can be pressure tested with this kit. The kit will work on other brands as well. See the Chain Saw Service Manual (p/n 60654) Section 2, page 13 and Section 9, page 90 for proper testing procedures



**100023**

### **Alcohol Tester**

See the Trimmer/Brushcutter Service Manual (p/n 60506) Section 13, page 113 and for more information.

## Miscellaneous



**22104-97800**

### **Spark Plug Wire Replacement Kit**

Simplifies spark plug wire repair. Diagram instructions are included. Fits all models.



**80187**

### **Snap Ring Installation Guides**

For use in conjunction with 20021-96601 Piston Puller Assembly Pg. 22. See Parts Revision PR-219 for details.

# ADHESIVES/LUBRICANTS



## 14-01 Screw Lock

A cost effective adhesive that helps lock screws tightly in place, yet permits easy removal when needed.



## 13-61 Anaerobic Threadlock



## 13-60 Anaerobic Sealant

Heavy duty adhesive resists extreme heat. Recommended for 5mm and larger screws only. Ideal for locking muffler bolts. See the Chainsaw Service Manual (p/n 60654) Section 9, page 96 for proper application



## 11-04 Liquid Gasket

Anaerobic locking adhesive for sealing crankcases on trimmers, brushcutters, lawn edgers and blowers. See Chain Saw Service Manual (p/n 60654) Section 8, page 88 for proper application

# ADHESIVES/LUBRICANTS



## 1207D High Temperature Liquid Gasket

A heavy duty silicone sealing material with excellent heat and chemical resistant characteristics. For sealing cylinder heads and crankcases. Ideal for Shindaiwa chain saws.



## 13-57 Lithium Gearcase Lube

Shindaiwa's gearcase lubricant for easy maintenance on all straight shaft trimmers and brushcutters. Also useful for flex shaft lubrication. See the Trimmer and Brushcutter Service Manual (p/n 60506) Section 11, Page 98 for proper maintenance procedures



## 13-58 Lithium Gearcase Lube

Shindaiwa's large tube of gearcase lubricant for easy maintenance on all straight shaft trimmers and brushcutters. Also useful for flex shaft lubrication. See the Trimmer and Brushcutter Service Manual (p/n 60506) Section 11, Page 98 for proper maintenance procedures



## 37-27 PowerBroom High Temperature Gearcase Lube

For early style PowerBroom gearcases only. See PR-159 and SB-42 for important service information

# TECHNICAL LITERATURE

\*Step by step service and troubleshooting procedures plus complete specifications for Shindaiwa products. Written and illustrated for mechanics.



**60654**  
**Chain Saw Service Manual\***  
Available on website



**10065-5**  
Available on website only  
**Chain Saw Service Manual\***  
(Horizontal Saws)



**60506 (English) 60876(Spanish) 60975 (French)\***  
**Trimmer/Brushcutter Service Manual**  
Available on website



**61305-1\***  
**Hedge Trimmer Gearcase Service Manual**  
Available on website



**60220\***  
**Water Pump Service Manual**  
Available on website

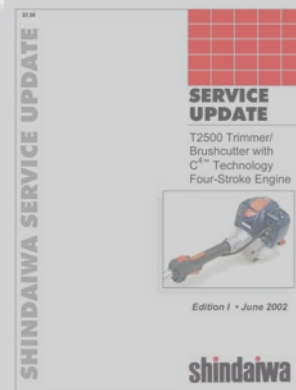

**80493\***  
**T2500 C-4 Service Manual**  
Available on website





61513

**Available on website only  
Piston Failure Analysis Guide**

This guide contains visual information on most failures common to 2-cycle engines.



61746 Trimmer Head Guide

Contains IPL information and line replacement techniques for most Shindaiwa trimmer heads.

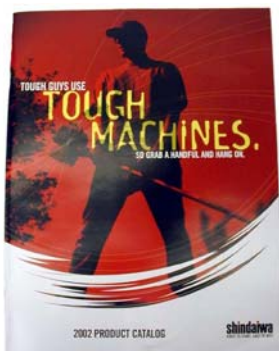

80430

**2002/2003 Product Catalog**

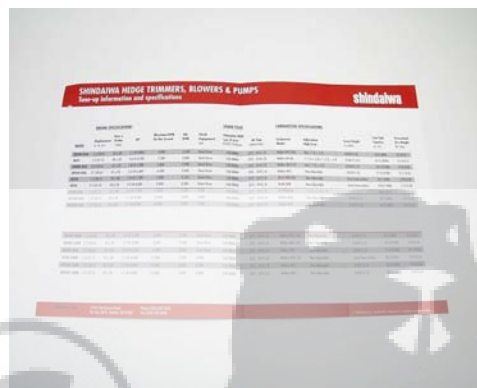

61515

**Shindaiwa "Other Products" Spec Chart**



61516

**Shindaiwa Trimmer/Brushcutter Spec Chart**

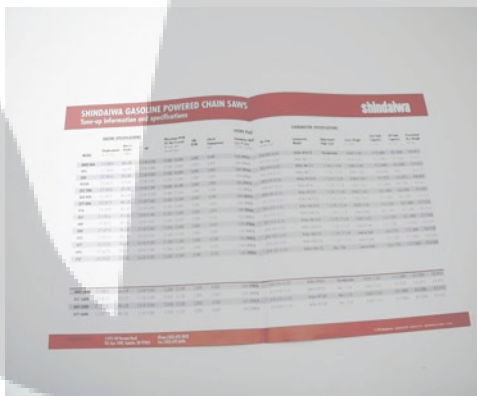

61233

**Shindaiwa Chain Saw Spec Chart**

# TECHNICAL LITERATURE



**99909-381**  
**Carburetor Inspection Checklist**



**60127**  
**Engine Seizure Checklist**



**61494-1 (Domestic) 61645 (International)**  
**CD-Rom III**  
 The CD-ROM disk contains the Shindaiwa Product Guide, Accessory Catalog, Illustrated Parts Lists, Technical Bulletins, Service Manuals and Parts Price List. Windows and Macintosh compatible.



**61296**  
**Shindaiwa Shop Repair Tags**

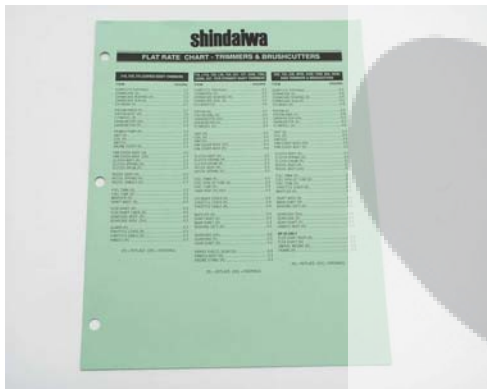

**61256**  
**Shindaiwa Flat Rate Chart**

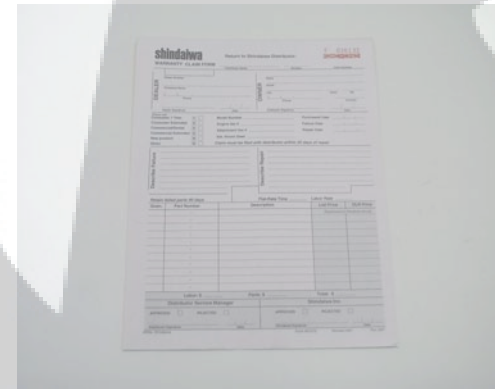

**61072**  
**Warranty Claim Form**

# VIDEO



**80476**  
**Be Smart-Be Sharp-Be Safe**  
**Chain Saw Safety Video**



**61931 (English) 80389 (spanish)**  
**Shindaiwa Trimmer & Brushcutter**  
**Safety Video**

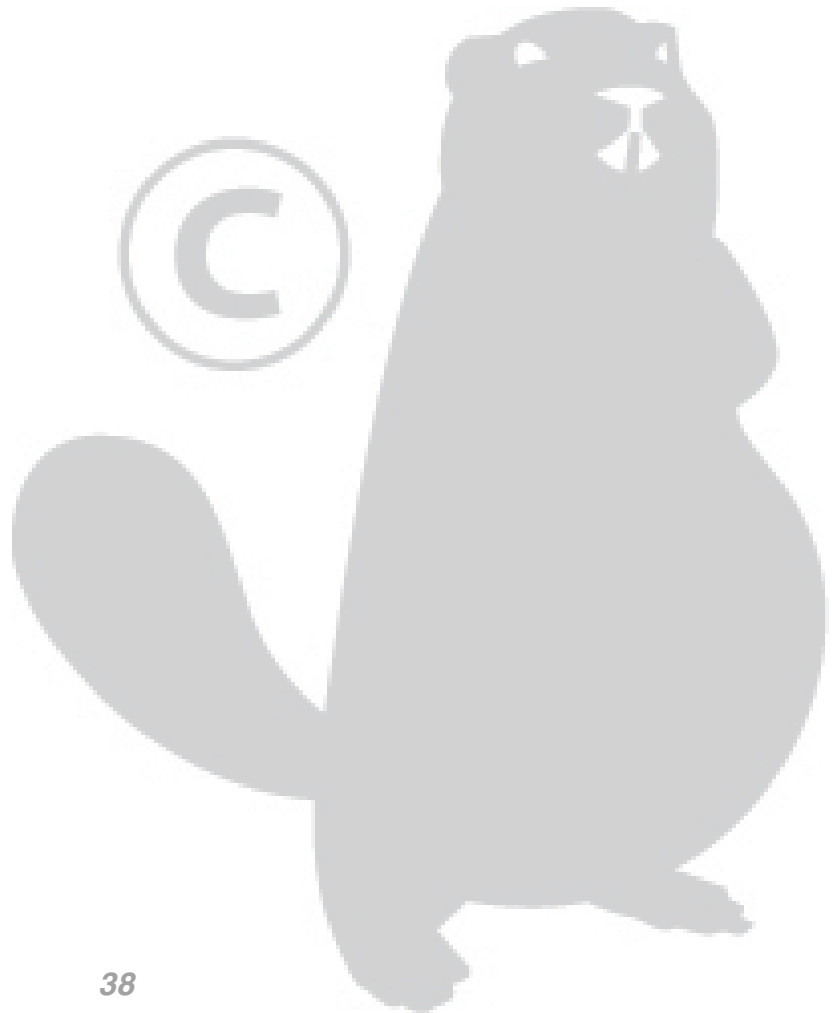

# V. APPENDIX

The following tables are for reference in finding the proper tools for a particular model.

## CURRENT MODELS

Model	Pin Adapter	Guide Pin	Flywheel Tool	Clutch Tool	Notes
T/F/DH22	push fit	push fit	20000-96104	x	
T/C/LE/PB/AH/P230	<b>20021-96650*</b>	20035-96630	20000-96104	x	
T/C/LE260	20021-96650	20000-96631	20000-96104	x	
T/C/PB270	<b>20021-96650*</b>	20000-96631	20000-96104	x	
C35/T/C350	20021-96660	20000-96631	20000-96104	x	
B45	20021-96660	20021-96630	20000-96104	x	
B450	20021-96660	20021-96630	20000-96104	x	
BP35	20021-96660	20000-96631	20000-96104	x	
RC45	20021-96660	20021-96630	20000-96104	x	
EB240	20021-96650	20035-96630		x	
EB480/EB500	20021-96660	20021-96630	20000-96104	x	
EB630	push fit	push fit		N/A	
GP450	20021-96670	20035-96630	20000-96104	x	
HT230	20021-96650	20035-96630	20000-96104	x	flywheel tool - must use bolts p/n 11020-06350 (2)
3005	20021-96660	20000-96631	20000-96104	22154-96110	clutch tool - can use chain saw flywheel tool
357	20021-96660	20021-96630	<b>22154-96100**</b>	use srench	
350 SAW	20021-96660	20000-96631	<b>22154-96100**</b>	22154-96110	clutch tool - can use chain saw flywheel tool
360	20021-96660	20000-96631	20000-96104	22154-96110	clutch tool - can use chain saw flywheel tool
377	20021-96660	20000-96631	20000-96104	22154-96110	clutch tool - can use chain saw flywheel tool
488	<b>20021-96660*</b>	20000-96631	<b>22154-96100**</b>	22155-91580	clutch tool - can use srench
577	20021-96660	20021-96630	<b>22154-96100**</b>	22155-91580	
757	22169-96350	22169-96360	<b>22154-96100**</b>	22169-96580	

\* File pin adapter down a little

\*\*Flywheel tool - can also use T/BC tool with two long bolts (p/n 22102-96130)

## DISCONTINUED MODELS

Model	Pin Adapter	Guide Pin	Flywheel Tool	Clutch Tool	Notes
T/C18	push fit	push fit	20000-96104	x	
T/C20	20021-96650	20035-96630	20000-96104	x	
F20	20021-96650	20035-96630	20000-96104	x	
F21	20021-96650	20035-96630	20000-96104	x	
T/C25	20021-96650	20000-96631	20000-96104	x	
T/C/LE250	20021-96650	20000-96631	20000-96104	x	
B40	20021-96660	20000-96631	20000-96104	x	
EB45	20021-96660	20021-96630	20000-96104	x	
GP25	20021-96650	20000-96631	20000-96104	x	
GP45	20021-96660	20021-96630	20000-96104	x	
HT20	20021-96650	20035-96630	20000-96104		
345	20021-96660	20000-96631	<b>22154-96100**</b>	22154-96110	clutch tool - can use chain saw flywheel tool
415	20021-96660	20000-96631	22154-96100	22154-96110	clutch tool - can use chain saw flywheel tool
416	20021-96660	20000-96114	22154-96100	22154-96110	clutch tool - can use chain saw flywheel tool
450	20021-96660	20000-96631	22154-96100	22154-96110	clutch tool - can use chain saw flywheel tool
451	20021-96660	20000-96631	22154-96100	22154-96110	clutch tool - can use chain saw flywheel tool
550	22150-96350	22150-96360	<b>22154-96100**</b>	22155-91580	
500	20021-96660	20000-96631	<b>22154-96100**</b>	22154-96110	clutch tool - can use chain saw flywheel tool
575	22150-96350	22150-96360	<b>22154-96100**</b>	22155-91580	
695	22155-96350	22155-96360	<b>22154-96100**</b>	22155-91580	

