

SHINDAIWA OWNER'S/OPERATOR'S MANUAL

488 CHAIN SAW

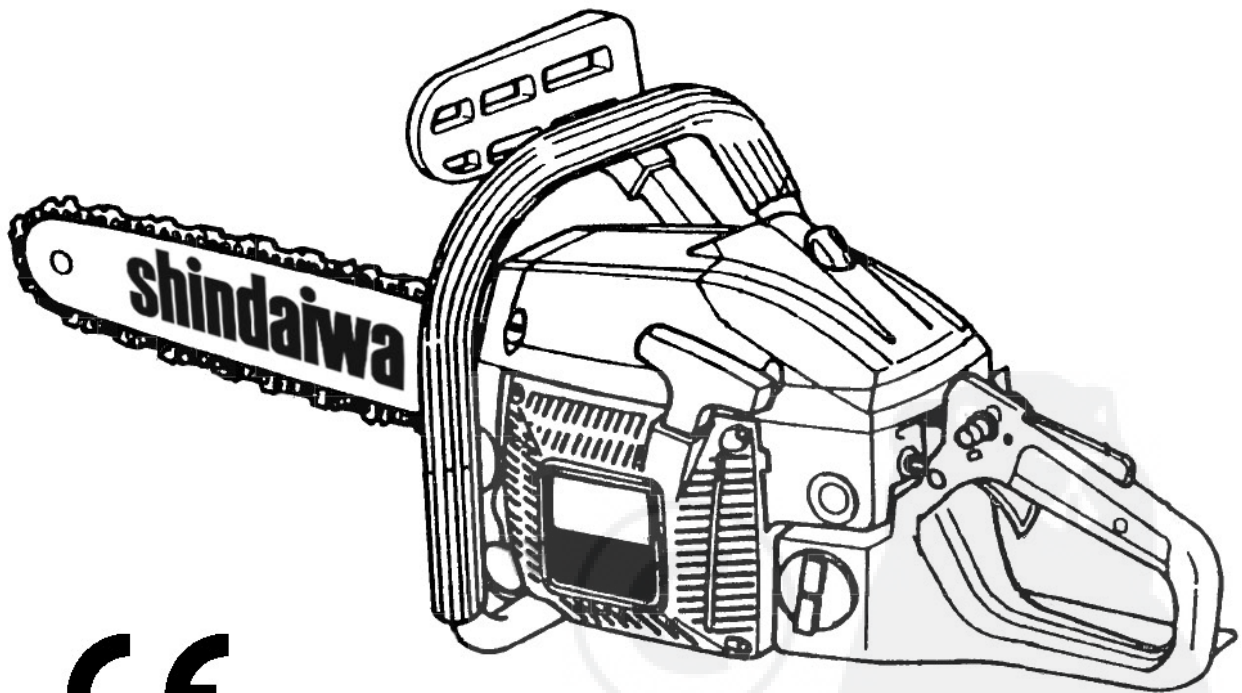

WARNING!

- Read this manual and familiarize yourself with its contents.
- This machine is designed for cutting wood and timber.
Use only for designated purpose.
- Minimize the risk of injury to yourself and others.
- Always wear eye protection when operating this machine.
- Do not operate or service this machine unless you clearly understand this manual.
- Keep this manual available at all times so that you can reference it whenever you have a question about the use of this unit.

shindaiwa

Part Number 69026-94310 Rev. 3/05

Introductions

The Shindaiwa 488 chain saw is designed and built to deliver superior performance and reliability without compromise to quality, comfort, safety, or durability. Shindaiwa high performance engines represent the leading edge of 2-cycle engine technology, and deliver exceptionally high power at remarkably low displacement and weight. As a professional owner/operator, you'll soon discover why Shindaiwa is simply in a class by itself.

IMPORTANT!

The information contained in this manual describes units available at the time of production. While every attempt has been made to give you the very latest information about your Shindaiwa 488 chain saw, there may be some differences between your saw and what is described here. Shindaiwa Inc. reserves the right to make changes in production without prior notice, and without obligation to make alterations to units previously manufactured.

Contents

	PAGE
Attention Statements	2
Labels and Symbols	5
Unit Description	6
Technical Specifications	6
Installing and Adjusting the Guide Bar and Saw Chain	7
Mixing/Filling Fuel	8
Bar Oil	8
Starting the Engine	9
Stopping the Engine	10
Carburetor Adjustments	10
Chain Brake	11
Cutting with the Saw	12
Maintenance	14
Saw Chain Performance	16
Troubleshooting	17
Declaration of Conformity	19

Attention Statements

Throughout this manual are special "Attention Statements".

 **WARNING!**
A statement preceded by the triangular attention symbol and the word "WARNING" contains information that should be acted upon to prevent serious bodily injury.

CAUTION!
A statement preceded by the word "CAUTION" contains information that should be acted upon to prevent mechanical damage.

IMPORTANT!
A statement preceded by the word "IMPORTANT" is one that possesses special significance.

NOTE:
A statement preceded by the word "NOTE" contains information that is handy to know and may make your job easier.



Read and follow the Operator's Manual. Failure to do so could result in serious injury.



Beware of Kickback! Kickback can occur whenever the tip of the guide bar touches an object while the saw is operating. Kickback may force the bar up and back toward the operator with a lightning-fast reaction!



Wear eye and hearing protection at all times during the operation of this unit.



Sound Power Level (measured in accordance with 2000/14/EC).

IMPORTANT!

All chain saw service, other than the items listed in the owner's manual maintenance instructions, should be performed by trained Shindaiwa chain saw service personnel. (For example, if improper tools are used to remove the flywheel, or if an improper tool is used to hold the flywheel in order to remove the clutch, structural damage to the flywheel could occur and could subsequently cause the flywheel to burst.)

Kickback Safety

This saw is equipped with the following safety equipment:

1. Inertia chain brake.

- Activating the chain brake tightens a brake band around the chain drive mechanism, stopping all chain rotation. When sudden kickback occurs, the chain brake is automatically actuated and the chain stops instantly. The chain brake can also be activated manually.



WARNING!

To reduce the risk of kickback, all of the above devices must be properly installed and in good repair!



WARNING!

Brake engagement and operation depend upon proper chain break condition! For proper chain brake testing and adjustment procedures, refer to page 11.

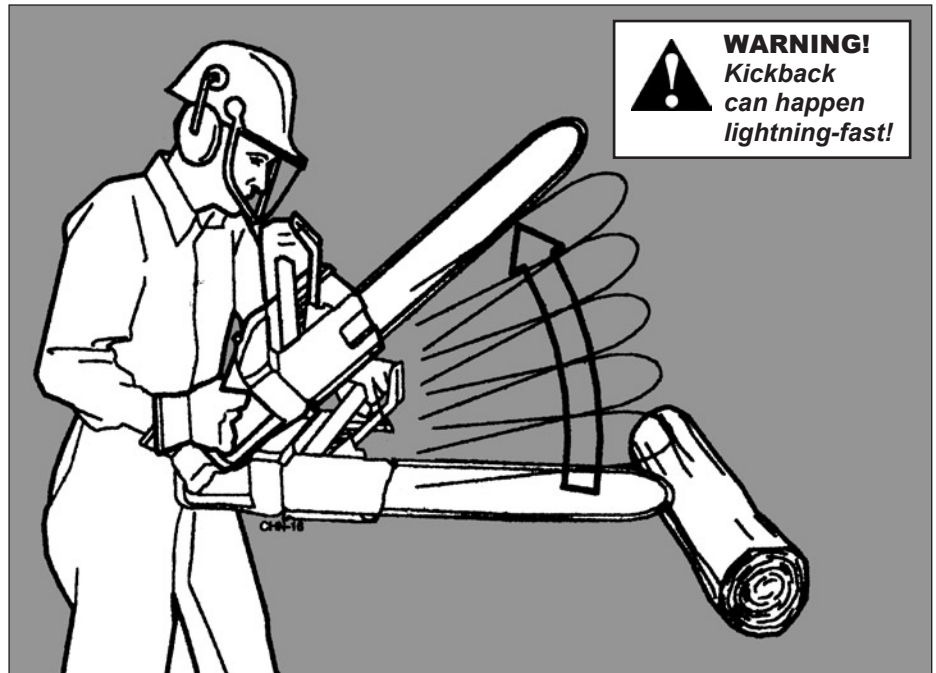

Kickback Safety Precautions

Either of the following reactions could cause you to lose control of your saw while cutting, possibly resulting in serious injury!

1. Kickback can occur whenever the guide bar nose or tip contact an object while the saw is running. Tip contact may cause the guide bar to kick upward and back toward the operator with a lightning-fast reaction!
2. Pinching the saw along the top of the guide bar may push the guide bar rapidly back toward the operator! Pinching can occur whenever wood closes in around the moving chain!

Do not rely exclusively on the safety devices incorporated with your saw. As a chain saw user, observing the following steps will also help you to avoid accident or injury on the job:

- Sudden surprise can contribute to accidents! With a basic understanding of kickback, you can reduce or eliminate the element of surprise.
- Clear obstructions from the work area before cutting. Remove any log, branch, or other obstruction that might contact the guide bar tip during cutting operations.
- Grip the saw firmly with your right hand on the rear handle and your left hand on the front handle, thumbs and fingers encircling the handles whenever the saw is running. Don't let go: A firm grip will help you to reduce kickback while maintaining control of the saw.
- Accelerate the saw before the chain contacts the work area, and always maintain high engine speeds throughout the cut.
- Do not overreach or attempt to cut above shoulder height.
- Follow the manufacturer's instructions for sharpening and maintenance of the saw chain.
- Use only the replacement bar and chain combinations specified by the manufacturer.
- Never stand directly over the saw while cutting!
- Use low-kickback chain, chain brakes, or special guide bars to reduce the risk of kickback.

Additional Safety Precautions



WARNING!

- Never operate this chain saw with one hand! One-handed operation could cause you to lose control, causing serious injury to yourself or others! A chain saw is intended for two-handed use.
- Wear safety footwear, snug-fitting clothing, protective gloves, and eye, hearing, and head-protection devices while working with this chain saw.
- Do not allow other persons to be near the chain saw when starting or running the chain saw. Keep bystanders and animals out of the work area.
- Never allow young children or any person unfamiliar with chain saws to operate this saw!
- Clear the work area before using the saw. Never start cutting until you are sure you have a secure footing and have planned a retreat path from the falling tree.
- Before starting the saw engine, make sure nothing is touching the saw chain.
- Keep all parts of your body away from the saw chain whenever the engine is running!
- Stop the engine before carrying the saw. Carry the saw with the engine stopped, the guide bar and saw chain pointing to the rear, and the engine muffler away from your body.
- Stop the engine before setting the chain saw down.
- Install the appropriate guide-bar chain cover before transporting the saw.
- Never operate this chain saw if you are fatigued or if you are under the influence of alcohol, drugs, or any other substance that could affect your ability or judgement.
- Never operate a saw that is damaged, improperly adjusted, or not completely and securely assembled.
- Do not use this saw if the saw chain continues to move after the throttle control trigger is released.
- Use only Shindaiwa-recommended parts when repairing or servicing this saw.
- Use extra care when cutting a limb that is under tension! A limb under tension could spring back suddenly, causing you to lose control of the saw!
- Use extreme caution when cutting smaller brush and saplings! Small-diameter material may catch in the chain and be whipped toward you or pull you off balance, causing you to lose control of the saw!
- Operate the saw only in a well ventilated area. Exhaust gases and lubrication oil mist can cause serious injury or death.
- Keep the saw handles dry, clean and free of oil or fuel mixture.
- Never operate any saw while in a tree unless you have been specifically trained to do so!
- Never perform service or repairs to this saw unless you are specifically trained and equipped to do so!
- Improper maintenance, use of nonconforming replacement components, or the removal of safety devices, such as the chain brake or any of the chain brake components, could result in serious injury.
- Never allow any part of your body near the clutch cover of an operating saw.
- Never operate a saw with damaged or missing anti-vibration cushions. Long-term exposure to vibration can damage your hands, in particular vascular, bone or joint, neurological or muscular disorders. For lowest vibration, replace damaged mounts immediately. Mounts hardened due to age or weathering should also be replaced.
- Always maintain a firm footing while operating this saw! Ladders and other temporary platforms can shift unexpectedly, and are not recommended!
- Do not operate this or any other chain saw with the muffler removed.
- All chain saw service, other than items listed in the owner's maintenance instructions, should be performed by trained Shindaiwa chain saw service personnel.
- Prolonged exposure to excessive noise is fatiguing and could lead to impaired hearing. The use of proper ear protection can reduce this potential hazard.

Safety Labels

IMPORTANT!

Safety and Operation Information Labels: Make sure all information labels are undamaged and readable. Immediately replace damaged or missing information labels. New labels are available from your local authorized Shindaiwa dealer.

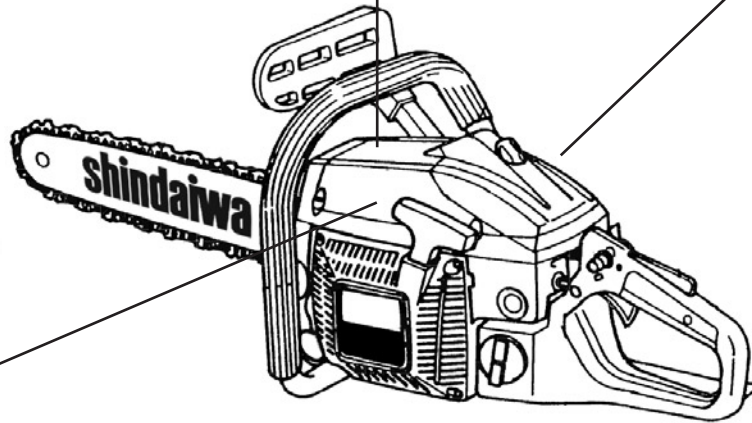
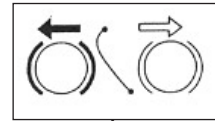

Chain oil filter opening

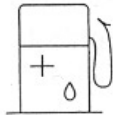

Fuel filter opening



Carburetor Adjustment
Idle Speed



Choke



Chain brake function

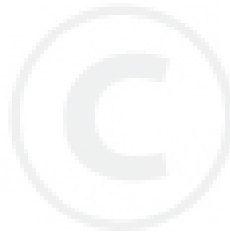

Unit Description

IMPORTANT!

The operational procedures described in this manual are intended to help you get the most from this unit and also to protect you and others from harm. These procedures are general guidelines only, and are not intended to replace any additional safety rules or laws that may be in force in your area. If you have any questions regarding your Shindaiwa chain saw, or if you do not understand something in this manual, your Shindaiwa dealer will be glad to assist you. For additional information, you may also contact Shindaiwa Inc. at the address printed on the back of this manual.

Tools Included

- Spark plug/13 mm socket wrench (Scrench).



WARNING!

Do not make unauthorized modifications to this saw, guide bar, or chain!

IMPORTANT!

The terms “left”, “left-hand”, and “LH”; “right”, “right-hand”, and “RH”; “front” and “rear” refer to directions as viewed by the operator during normal operation.

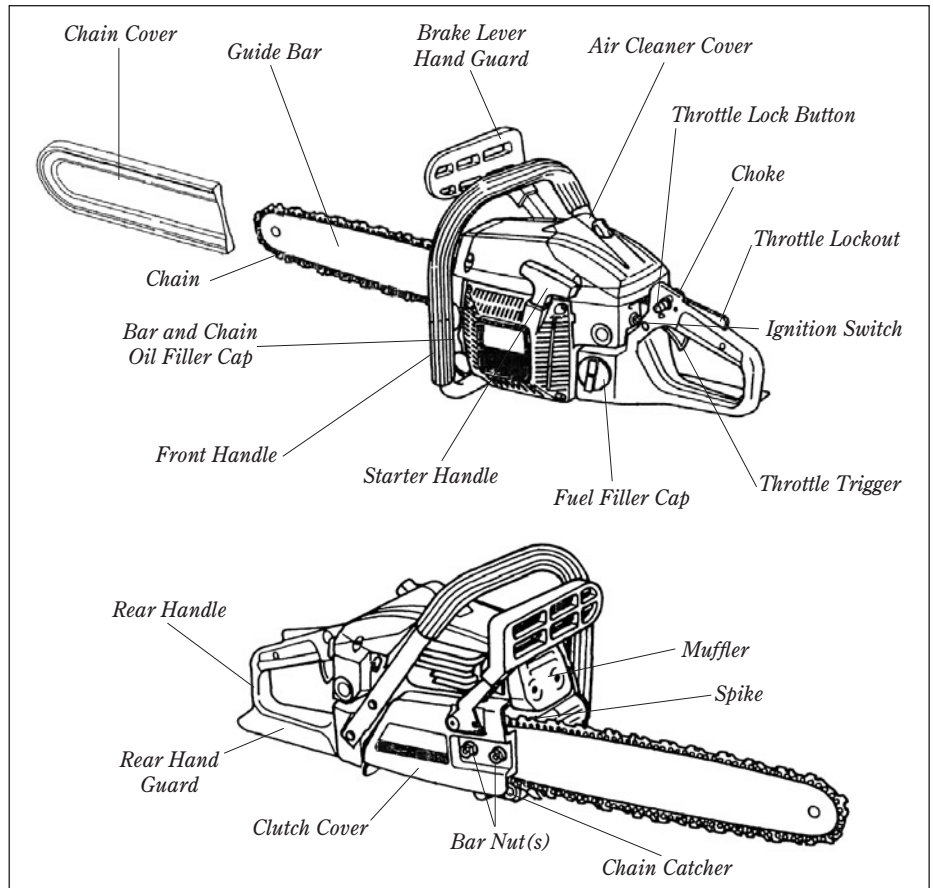

Using the accompanying illustrations as a guide, familiarize yourself with your machine and its various components.

Understanding your machine helps ensure top performance, long service life, and safer operation.

Specifications

Model Name	488	Recommended	
Displacement	47.9 cm ³	Chain Type	Blount type 21 BP, pitch 0.325", gauge 0.058"
Bore X Stroke	43 x 33 mm	Number of Rim Tooth.....	7
Maximum Power Output *1)	1.9 kW	Specified Pitch of Drive Sprocket	0.325"
Recommended Maximum Engine Speed *2) ...	14,000 min ⁻¹	Starting.....	Recoil Starter
Recommended Engine Speed at Idling	2,800 min ⁻¹	Ignition	Electronic ignition system
Engine Type	2-cycle, vertical cylinder, Air-cooled	Spark Plug.....	NGK BPMR7A
Cooling System	Forced Air	Power Transmission	Automatic Centrifugal Clutch
Carburetor	Diaphragm	Handle	Anti-vibration
Fuel.....	Gasoline 2-cycle mixing oil mixture 50:1	Safety Devices	In conformity with the CE Mark regulations
Fuel Tank Capacity	600 ml	Chain Lubrication.....	Automatic adjustable flow rate
Oil Tank Capacity.....	300 ml	Weight (less bar/chain)	4.8 kg
Recommended Bar Size	33 cm (13"), 38 cm (15"), 40 cm (16"), 45 cm (18"), 50 cm (20")	Sound Power Level *3)	108 dB (A)
Recommended Bar Type.....	Sprocket Nose Bar	Sound Pressure Level *4)	100 dB (A)
		Vibration Level *5) (Front handle)	5.8 m/s ²
		Vibration Level *5) (Rear Handle)	7.4 m/s ²

*1) measured in accordance with ISO 7293

*2) with bar and chain

*3) measured in accordance with ISO 9207

*4) measured in accordance with ISO 7182

*5) measured in accordance with ISO 7505

Installing and Adjusting the Guide Bar and Saw Chain

NOTE:

For longest chain life, place new or replacement chain loops in oil and soak overnight before installation.

IMPORTANT!

The chain brake must be completely disengaged before removing or installing the clutch cover.

1. Use the socket wrench to remove the clutch cover nut(s) in a counter-clockwise rotation.
2. Remove the clutch cover.
3. Remove and discard the packing spacer.
4. Place the guide bar over the guide bar stud(s) and chain tensioner pin.

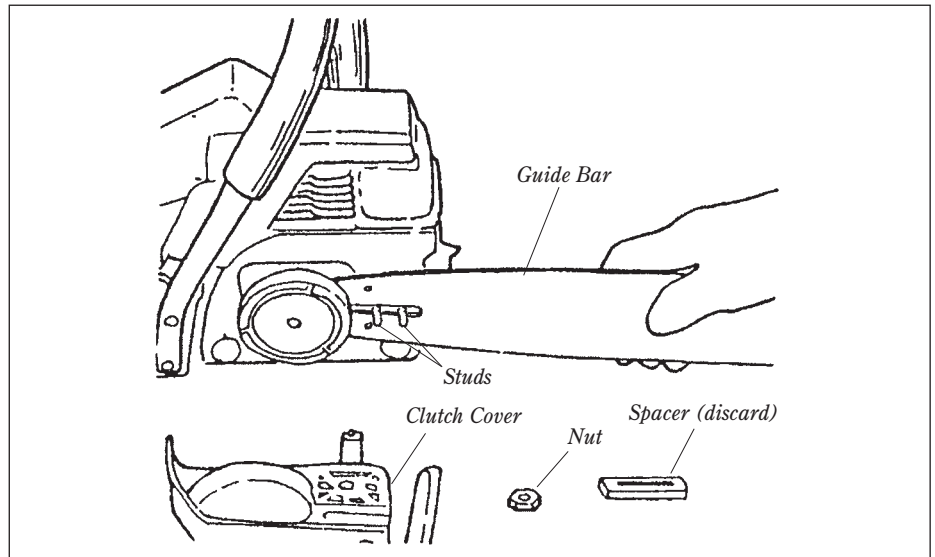

CAUTION!

Failure to align the guide bar and chain tensioner pin can cause serious damage to the clutch cover, guide bar, tensioner pin, and/or engine crankcase!

WARNING!

The cutters on the saw chain are very sharp! Always wear gloves when handling.

5. Install the chain loop over the drive sprocket, and then align the chain drive links within the guide bar groove. Verify that the cutters are properly oriented with cutter edges facing forward on top of bar. If chain installation is difficult or if the chain appears too tight, refer to step 8 on the next page.
6. Install the clutch cover over the bar stud(s) and install the bar nut(s) finger tight.

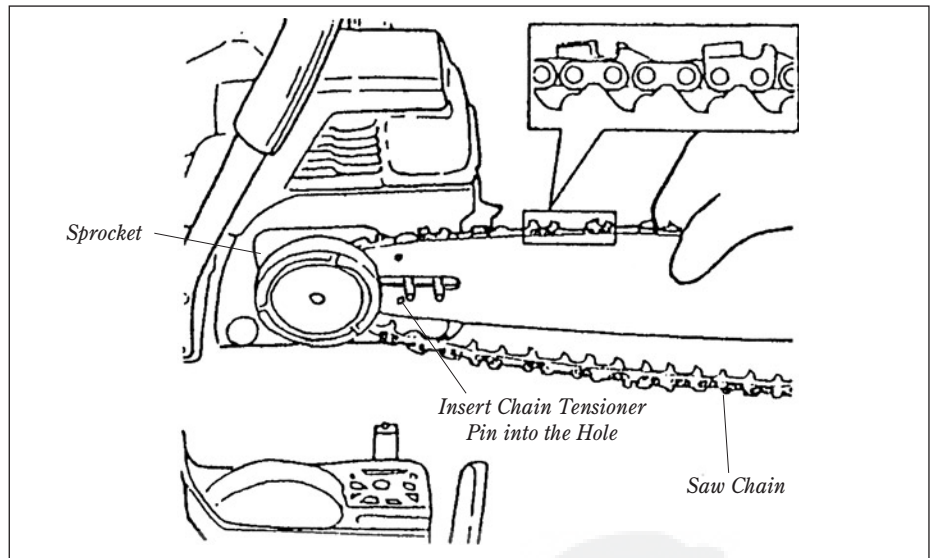

9. Tighten the bar nut(s). The saw chain tension is correct when there is not any slack on the bottom of the guide bar but the saw chain can move freely.

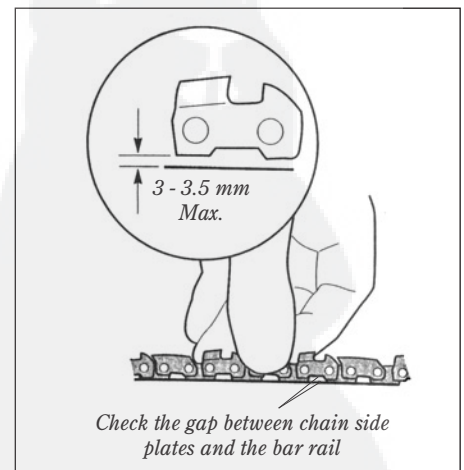

WARNING!

Never operate this saw without the clutch cover installed.

IMPORTANT!

Proper chain adjustment is essential for maximum performance, chain life, and operator safety. Always inspect chain tension before operating this saw!

7. Place the saw on a flat surface and lift the bar nose slightly.
8. To adjust chain tension:
 - Turn the chain tension screw clockwise to tighten the chain.
 - Turn the chain tension screw counter-clockwise to loosen the chain.
 - While lifting the bar nose, tighten or loosen the adjusting screw until the chain at mid-bar on the bottom of the bar just contacts the guide bar rails.

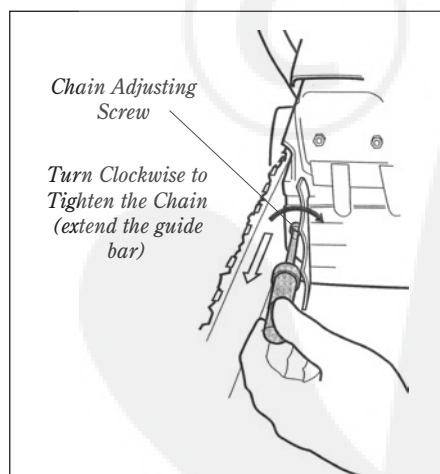

Re-adjusting the Saw Chain

1. To adjust chain tension in the field: Stop the saw and allow the guide bar and chain to cool. Loosen both bar nuts approximately 1-turn each, and then perform steps 7-9 above. Never operate the saw with a loose chain!

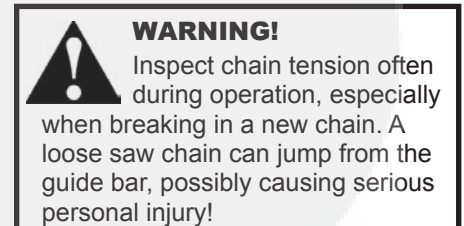

Mixing Fuel/Filling With Fuel



WARNING!

Minimize the risk of fire, burns, and personal injury!

- STOP engine before refueling.
- ALWAYS allow the engine to cool before refueling!
- ALWAYS open the fuel cap slowly to allow any pressure build-up in the tank to release fuel vapor slowly.
- Avoid overfilling and wipe up all spilled fuel. Move the engine at least 3 meters from the fueling point, storage area and other readily flammable materials before restarting!
- ALWAYS inspect the unit for fuel leaks before each use. During each refill, make sure there are no fuel leaks around the fuel cap and/or tank. If a fuel leak is evident, stop using the unit immediately. Fuel leaks must be repaired before using the unit.
- NEVER smoke or light any fires near the engine or fuel source!
- NEVER place any flammable material near the engine muffler!
- NEVER operate the engine without the muffler in good working condition.

IMPORTANT!

Shindaiwa high-performance 2-cycle engines are designed to operate on a 50:1 mixture of unleaded gasoline and 2-cycle mixing oil. Using a fuel mixture less than 50:1 ratio (such as 80:1 or 100:1) can cause catastrophic engine failure!

1. Use only fresh, clean unleaded gasoline with a pump octane rating of 87 or higher.
2. Mix fuel with a 2-cycle mixing oil designed for use in high-performance 2-cycle air-cooled engines.

Gasoline liters	2-cycle mixing oil milliliters
2.5 l.....	50 ml
5 l.....	100 ml
10 l.....	200 ml
20 l.....	400 ml

3. Place the saw on a hard surface with the fuel cap up and wipe any chips or debris from around the fuel cap.
4. Remove the fuel cap and fill the tank with clean, fresh 2-cycle fuel mix. Avoid overfilling and fuel spillage.
5. Wipe any spilled fuel and move the saw at least 3 meters from the fueling point before starting the engine.

CAUTION!

- Some types of gasoline contain alcohol. Never use any type of gasoline containing more than 10% alcohol by volume! More than 10% alcohol by volume may affect the lubricating qualities of 2-cycle mixing oils reducing engine life and/or causing engine failure.
- Generic mixing oil and marine engine oil may not be intended for use in high-performance 2-cycle engines and should never be used in Shindaiwa engines. Mixing oils not intended for use in high-performance air-cooled 2-cycle engines can cause excessive carbon deposits, reduce engine life and/or cause engine failure.

Bar Oil / Filling With Oil

Oil Requirements

- When available, use Shindaiwa Premium bar and chain oil.
- When Shindaiwa oil is not available, use a premium 30-weight oil specifically blended for bar and chain lubrication.
- For cold weather operation, bar oil may be thinned by mixing with clean kerosene at a ratio of 1:1.

Filling the Oil Reservoir

- Place the saw on its side (clutch cover down), and wipe any chips or debris from around the oil cap.
- Remove the oil cap at the front of the saw.
- Fill the oil reservoir with bar and chain oil and replace the cap.
- Wipe spilled oil from handles and controls before starting the saw.

CAUTION!

Proper lubrication is critical to the performance and service life of your saw's oil pump, guide bar, and saw chain! Always use a high quality lubricating oil designed for saw chain lubrication! Never use dirty or reclaimed oil!

Oil Pump Adjustment

Guide bar and saw chain lubrication is automatically provided by an adjustable-rate oil pump designed to operate whenever the clutch drum rotates. A temporary increase in oil flow rate is often desirable when cutting hardwoods or large-diameter softwoods, and can be provided as follows:

1. Stop the engine and verify that the engine stop switch is in the "OFF" position.

2. Place the saw on its side, with the clutch cover facing up.

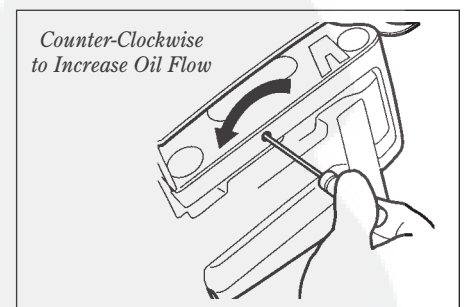

3. Use a screwdriver to push down and turn the oil flow rate adjustment screw.
 - Clockwise to decrease bar and chain lubrication.
 - Counter-clockwise to increase bar and chain lubrication.

Starting the Engine



WARNING!

This chain saw is equipped with a fast idle feature for ease of engine starting. When the fast idle is set, the saw chain will rotate when the engine starts! Rotating saw chain can cause serious injury. Clear a safe work area before starting the engine.

NOTE:

This engine ignition system is controlled by a two-position "ON-OFF" switch labeled "I" for ON and "O" for OFF located near the rear handle.

IMPORTANT!

This chain saw is equipped with a throttle trigger lock out system designed to prevent unintended throttle activation. This system requires the operator to first depress the throttle lock out lever on top of the rear handle to release the trigger from the engine idle position.

Engine Start:

1. Move the ignition ON-OFF switch to the ON position.
2. Pull the choke lever all the way out. (choke closed).

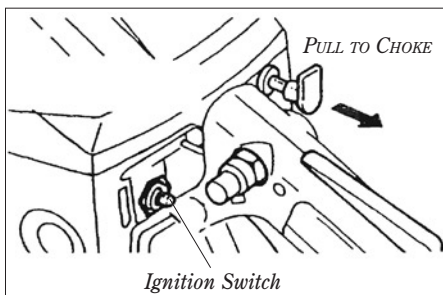

3. Depress the throttle lock lever (1).
4. Squeeze the throttle trigger (2).
5. Press and hold the throttle lock button (3) while releasing the throttle trigger.

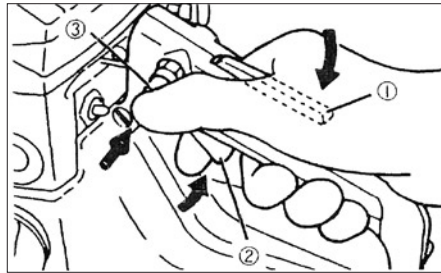

6. Place the saw upright on the ground.
7. Secure the saw by stepping on the inside of the rear handle with the right foot and firmly grasping the front handle with the left hand.
8. Grip the starter handle with the right hand and pull slowly until starter engagement is felt.

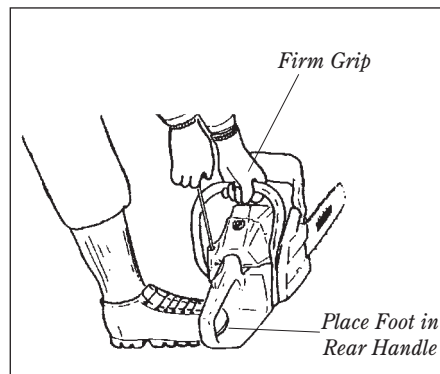

9. With the starter engaged, pull the starter upward. Repeat until the engine either attempts to start or starts.

CAUTION!

The recoil starter can be damaged by abuse!

- Never pull the starter completely to the end of the starter cord. Fully extending the starter cord can damage the starter spring, cord and/or starter assembly.
- Never release the starter grip with the starter rope extended. Always hold on to the grip during engine start and return the starter grip back to the starter housing slowly as the starter spring retracts the rope.

10. When the engine attempts to start or starts, push the choke control in if previously set. If the engine does not continue to run, pull the starter until the engine restarts then immediately press and release the throttle lever to disengage the fast idle.

NOTE:

If the engine fails to start, repeat the starting procedure setting the choke control appropriately for either a cold or warm engine. If the engine still fails to start, refer to the section, "Starting a Flooded Engine."

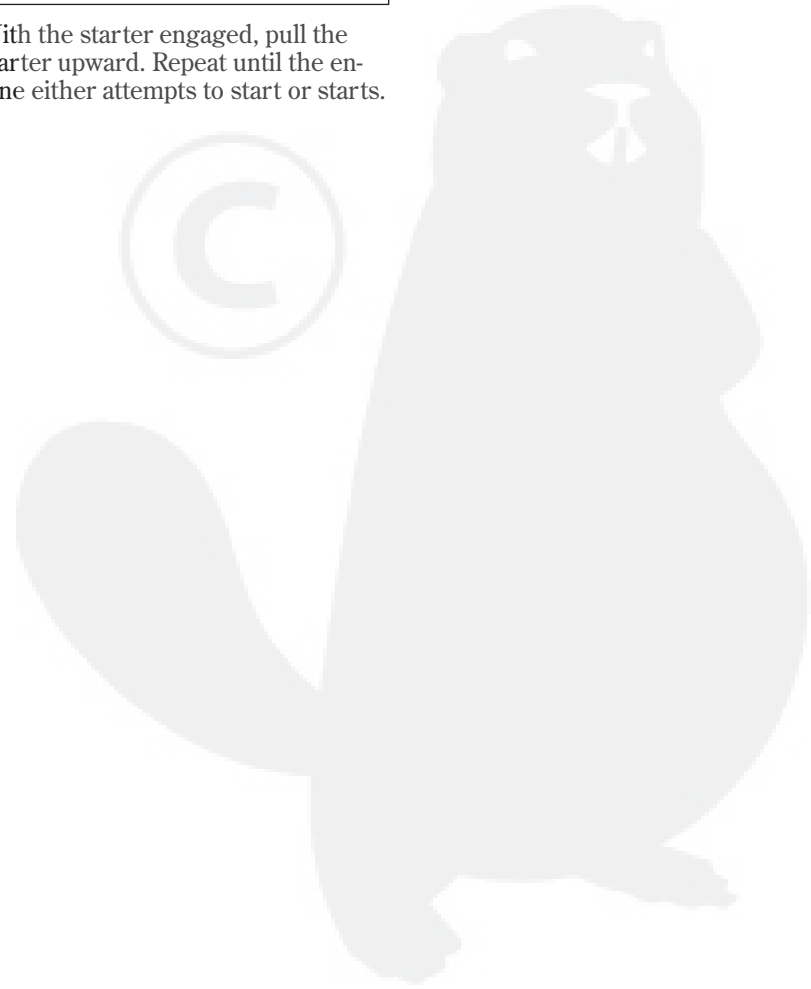

Starting a Flooded Engine

If the carburetor choke is closed (choke control fully extended) and after repeated attempts, the engine fails to start, the engine may be flooded with fuel. The following steps are recommended to clear a flooded engine.

1. Move the "ON-OFF" ignition control switch to the "OFF" position.



WARNING!

The ignition switch must be in the "OFF" position to prevent the chance of igniting fuel and/or fuel vapors escaping from the engine during this procedure.

2. Push the choke control completely in to open the choke.
3. Remove the spark plug access cover and disconnect the plug wire. Remove the spark plug.
4. Inspect the spark plug for damage or excessive wear and replace if necessary. If the spark plug electrode is fuel soaked, or coated with carbon deposits, clean and set the plug gap. Refer to page 14 of this manual in the Maintenance section for spark plug information.



WARNING!

Keep clear of the spark plug opening! Any excess fuel in the engine will be ejected through the spark plug opening during starter operation.

5. With the spark plug removed, the choke control pushed in and the ignition control in the "OFF" position, clear any excess fuel in the engine by repeatedly pulling the starter until no evidence of fuel is seen escaping from the spark plug opening.
6. Replace the spark plug and install the spark plug lead and access cover.
7. Refer to the Engine Start and Stop section and follow the instructions for starting a warm engine.
8. If the engine still fails to start, refer to the Troubleshooting section.

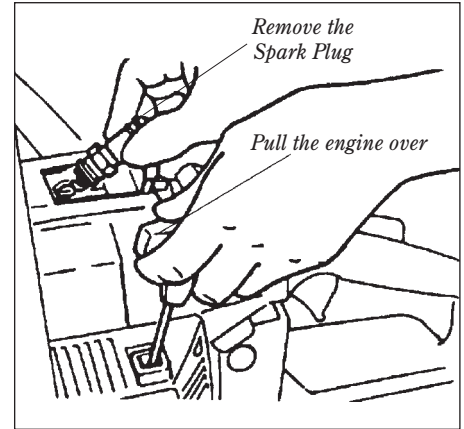

Stopping the Engine

1. Move the "ON-OFF" ignition control switch to the off position. If the saw has just been used, allow the engine to idle for 1 to 2 minutes to stabilize engine operating temperature before stopping the engine.

Carburetor Adjustments



WARNING!

The saw chain must never rotate at engine idle speed.

Idle Speed Adjustment:

Use a screwdriver to slowly turn the idle speed adjusting screw clockwise or counter-clockwise until the engine idles at 2,800 min⁻¹.

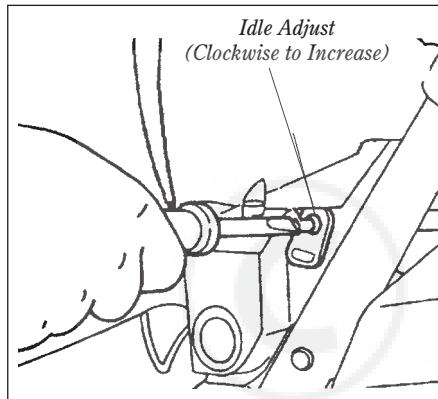

CAUTION!

- Never run the engine at full throttle with no-load. This may cause engine seizure.
- Never operate this saw above 14,000 min⁻¹. This may cause engine seizure.

NOTE:

Low speed mixture and high speed mixture for the 488 saw are factory set and can not be adjusted in the field.

Chain Brake

Chain Brake Operation

This saw is equipped with a dual function chain brake designed to stop the saw chain from rotating whenever kickback occurs.



WARNING!

The chain brake is installed only to reduce the risk from kickback! The chain brake is not a substitute for careful operation!

IMPORTANT!

The chain brake system for this unit type 488 is not adjustable! If the chain brake fails to stop the chain in any of the following steps, **DO NOT USE THE SAW!** Return the saw to your dealer for repairs.

IMPORTANT!

Release the throttle whenever the chain brake is activated!

- Engaging the brake lever causes a brake band to tighten around the clutch drum, stopping the saw chain.
- The chain brake is designed to engage whenever the brake lever strikes the operator's hand or from the inertial effects of kickback.
- The chain brake can also be activated by pushing the brake lever forward manually.

To release (disengage) the chain brake, pull the brake lever rearward, towards the front handle until a positive stop is felt.

Chain Brake Testing



WARNING!

Both of the following testing procedures must cause the chain brake to engage and prevent the saw chain from moving! If the chain brake does not fully engage and prevent the saw chain from moving during either test, **DO NOT OPERATE THE SAW!** Return the saw to your dealer for repairs!

Step 1: Inertia Chain Brake Function (engine "OFF")

Use the following procedure to test for proper operation:

1. Turn the engine "OFF," and verify that the ignition switch is in the "O" or "OFF" position.
2. Hold the chain saw normally, gripping the rear handle with the right hand and the front handle with the left hand. While keeping the chain saw level, hold the nose of the guide bar approximately 35 cm above a solid wood block. Release the front handle only and allow the guide bar nose to drop onto the wood. The chain brake lever should move forward to position 2 and activate the brake as soon as the nose strikes the wood block. Wearing gloves, make sure that the saw chain cannot be pulled around the guide bar.

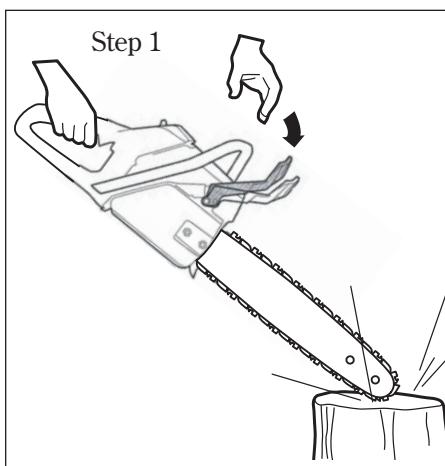

CAUTION!

Operating the saw at wide open throttle for longer than 5 seconds without a load could result in engine damage.

3. Accelerate engine to full throttle, then, without releasing the front handle, roll the left wrist forward against the front hand guard/chain brake lever to push the brake lever forward until the chain brake activates (position 2). The saw chain must stop immediately. If either of step 1 or step 2 tests fail, contact an authorized Shindaiwa dealer for repairs.

Step 2: Manual Chain Brake Function (engine running)

Use the following procedure to test for proper operation:

1. Start the saw and warm the engine to operating temperature.
2. With the saw on a flat stable surface, maintain a firm grip on the rear handle with the right hand and the top of the front handle with the left hand. The left hand should be centered with the front hand guard.

Step 2

1 Chain Can Move

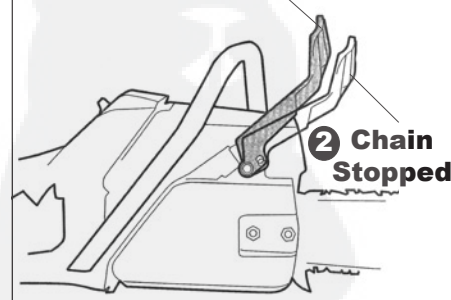

2 Chain Stopped

Chain Brake Maintenance

CAUTION!

Never start or operate this saw while the chain brake is activated!

- Periodically clean the brake mechanism of sawdust or debris.

- If the chain brake becomes damaged or worn, or fails to completely engage or release the clutch drum, return the saw to your dealer for repairs.
- Always stop the saw and disengage the chain brake before removing or replacing the clutch cover!
- Never make carburetor adjustments while the chain brake is engaged!
- Never carry the saw by the brake lever! Carry the saw by the front handle.

Cutting with the Saw

IMPORTANT!

Always use full throttle while cutting! Keep the chain sharp and let the saw do the work! Forcing the saw into the wood reduces cutting performance, and can damage the saw through overheating!

Wear close-fitting clothing to protect your legs and arms. Do not wear clothing or jewelry that could get caught in the machinery or brush.



Stop the saw before moving it to or from the work area.

Wear hearing protection and eye protection such as a face shield or goggles when operating the unit to shield against saw dust.

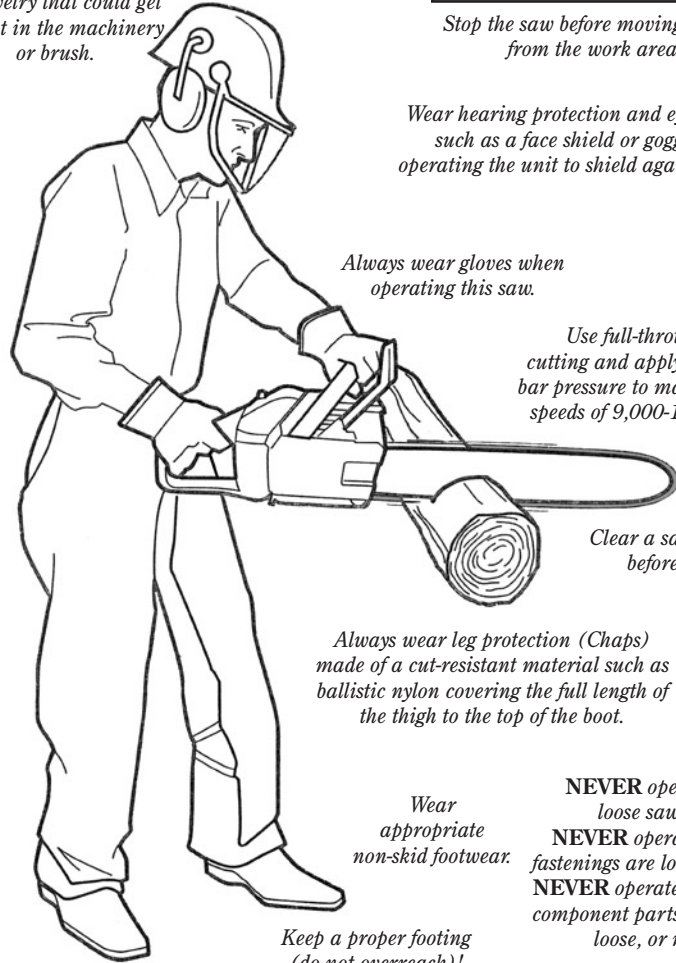

Always wear gloves when operating this saw.

Use full-throttle while cutting and apply only enough bar pressure to maintain engine speeds of 9,000-10,000 min⁻¹.

Clear a safe work area before cutting.

Always wear leg protection (Chaps) made of a cut-resistant material such as ballistic nylon covering the full length of the thigh to the top of the boot.

Wear appropriate non-skid footwear.

NEVER operate with a loose saw chain!
NEVER operate the saw if fastenings are loose or missing!
NEVER operate the saw if any component parts are damaged, loose, or missing!

Keep a proper footing (do not overreach)!

Felling Trees

Before Felling a Tree

- Determine the direction of fall by inspecting:
 - Tree shape and angle of lean.
 - Size and shape/placement of limbs.
 - Location of nearby trees or other obstacles.
 - Condition of tree (damage, disease, etc.).
 - Prevailing wind direction.
2. Clear a safe work area around the tree. Be alert for loose or dead limbs overhead. Clear an appropriate escape path approximately 45° from the direction of fall.
3. Notify nearby workers of your intentions!

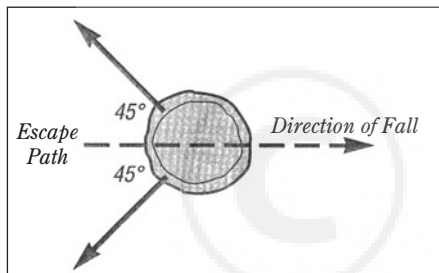

WARNING!

Diseased, damaged, or otherwise unbalanced trees can fall unpredictably during felling, and should be left to an experienced timber feller!

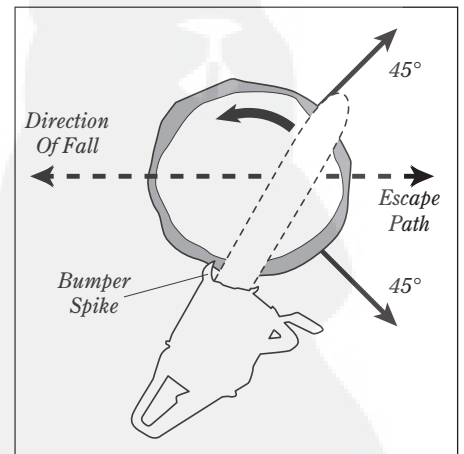

Felling Small Trees

(Under 15 cm diameter)

- Determine the direction of fall. If uncertain as to the direction of fall, use the procedure "Felling Large Trees" as outlined in the next section.

- Engage the bumper spike against the trunk of the tree and start to cut on the side of the tree away from the fall. Make a single cut all the way through the tree.
- When the tree begins to fall, stop the saw, and put it down on the ground.
- Use your retreat path to exit the area quickly.

Felling Trees (continued)

Felling Larger Trees

(Over 15 cm diameter)

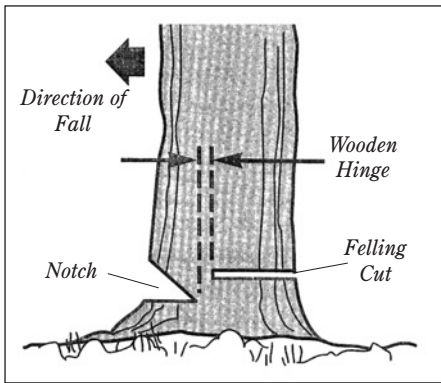

- If a tree is otherwise healthy and not seriously out of balance, its direction of fall can often be encouraged by first “notching” the tree on the side facing the desired direction of fall.
- After the notch is completed, start the felling cut slightly higher and on the opposite side of the tree, away from the direction of fall.
- The goal of the method is to leave a sturdy wooden “hinge” for the tree to pivot on while falling.

1. Determine the direction of fall.
2. On the side of the tree facing the direction of fall, make a single 90° cut through approximately 1/3 of the tree’s diameter.
3. Working from the same side of the tree and at a 45° angle to the first cut, make your second cut in an upward direction to remove a notch from the tree as shown.

Bucking



WARNING!

Always cut downed timber from the uphill side of the wood! Be alert for potential injury from rolling or shifting logs! Downed timber may shift or roll unpredictably during cutting or handling operations!

Techniques

- If the log is well supported, start your cut from the top of the log. Keeping the guide bar parallel to the ground, cut straight down but do not allow the saw to cut into the ground.
- Cutting downed timber, or “bucking,” increases the possibility of the wood settling and pinching the guide bar. Driving one or more soft plastic or wooden bucking wedges can help prevent bar-pinching during a cut.
- Use two cuts when bucking near the inboard end of an unsupported log.



WARNING!

Failure to leave a proper wooden hinge during the falling or “back cut” can cause the tree to pinch the saw’s guide bar and may also change the direction of fall!



WARNING!

Always make your falling cut parallel to the bottom cut! An angled falling cut may cause the tree to split, possibly changing the direction of fall!

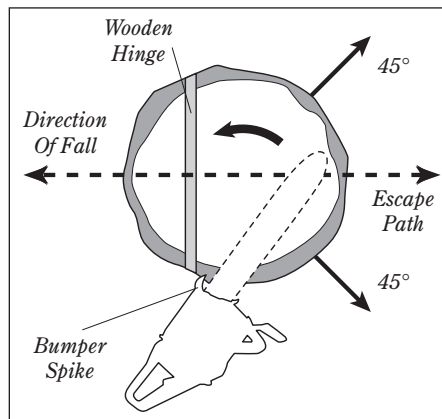

4. Working on the opposite side of the tree and starting approximately 2” higher than the bottom of the notch created in steps 1-3. Set the bumper spike just behind the felling hinge. Use full throttle and bring the bar and chain slowly into the tree. Make sure the tree does not start to move in the opposite direction to your intended felling direction. Drive a wedge or breaker bar into the cut as soon as it is deep enough.

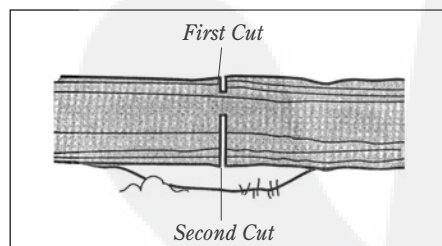

- Use two cuts when bucking the outboard end of an unsupported log. Your first cut should be an underbuck, cutting upward through approximately 1/3 the diameter of the tree. Finally, move to the top of the log and finish the cut by bucking down (overbucking) to your first cut.

NOTE:

If the cut appears to be closing on the bar, use a mallet to drive one or two plastic or wooden wedges into the cut behind the bar.

5. When the tree begins to fall, stop the saw, and put it down on the ground.
6. Use your retreat path to exit the area quickly.

Limbing

Limbing a standing tree is usually accomplished in the same manner as bucking, with a third and final cut used to remove the remaining stub of the limb.

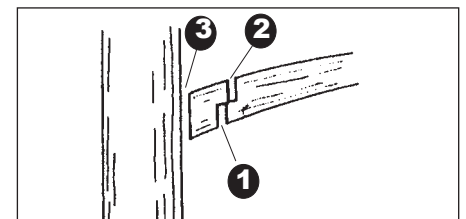

WARNING!

Kickback danger increases in over-height or out of position cutting! Do not overreach or attempt to cut above shoulder height!

NOTE:

When cutting unsupported logs or limbs, starting with an underbuck cut will minimize the possibility of the wood splitting during the bucking cut.

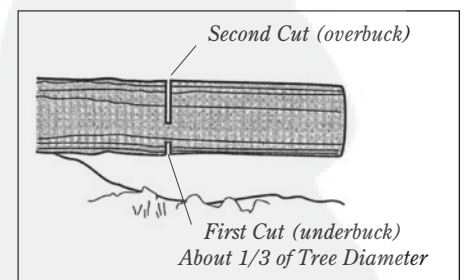

Maintenance



WARNING!

Before performing any maintenance on this saw, stop the engine and disconnect the spark plug wire!

Daily Maintenance

1. Remove dirt and debris from the saw exterior, cylinder fins, and cooling air intake.
2. Inspect the saw for fuel and oil leaks. Repair as necessary.
3. Service the air filter.
 - Remove the air filter cover and then remove the element. Use extreme care to prevent any debris from entering the carburetor bore. Wash all parts with soap and water, and then gently wipe or blow dry before reassembly.

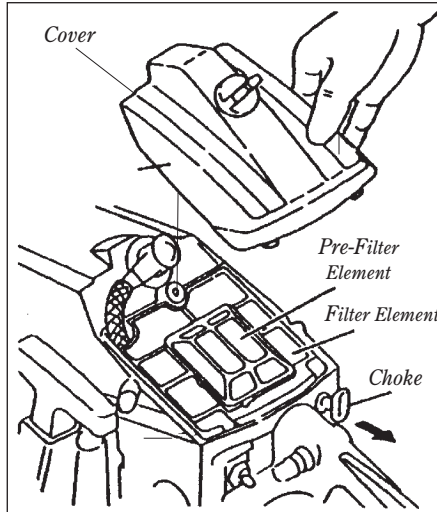

- Install the air filter element in the saw.

4. Sharpen and adjust the saw chains as required.
5. Clean the guide bar groove and oil hole, and inspect the bar groove and tip for damage or unusual wear. Repair or replace worn or damaged components as necessary.
6. Inspect the drive sprocket.
7. Inspect the entire saw for damaged, loose or missing components or fastenings. Repair as necessary.

10/15 Hour Maintenance

1. Remove and clean the spark plug. Adjust the spark plug gap to 0.6 mm, and reinstall. Replace any damaged or visibly worn plug with an NGK BPMR7A or equivalent spark plug of the same heat range.

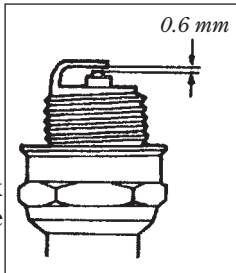

CAUTION!

Never allow chips or other debris to enter the cylinder bore! Before removing the spark plug, thoroughly clean the spark plug and cylinder head area!

2. Remove the guide bar and chain. Carefully inspect the drive sprocket for wear or damage, and replace if noted. Inspect the guide bar grooves and tip for wear or damage, and repair or replace components as required.

IMPORTANT!

The drive sprocket and saw chain loop should always be replaced as a set! For economy, rotate the same 2-3 chains daily. When these chains are worn out, replace both the chains and drive sprocket at the same time.

40/50 Hour Maintenance

1. Replace the spark plug with an NGK BPMR7A (or equivalent), gapped to 0.6 mm.
2. Use a hooked wire to extract the fuel filter from inside the fuel tank, and then remove and replace the filter element. Before replacing the filter, inspect the condition of the fuel line. If damage or deterioration are noted, the saw must be removed from service until it can be inspected by a Shindaiwa-trained service technician.

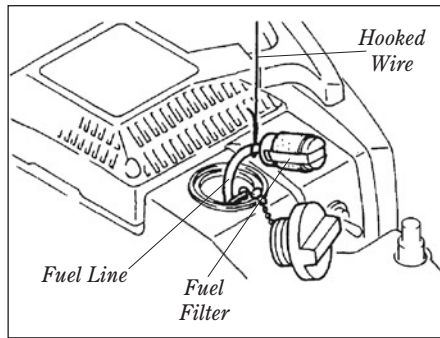

CAUTION!

Make sure you do not pierce the fuel line with the end of the hooked wire. The line is delicate and can be damaged easily.

3. Extract the oil filter from inside the oil tank, and then wash the filter element in an approved solvent. If damage or deterioration are noted on the oil suction line, the saw must be removed from service until it can be inspected by a Shindaiwa-trained service technician.

Long Term Storage

(over 30 days)

- Thoroughly clean the saw exterior. Remove all chips and other debris from the cylinder fins and cooling passages.
- Drain the fuel tank, and then clear the carburetor and lines by running the saw until it stops from lack of fuel.
- Drain any remaining bar oil from the oil reservoir.

CAUTION!

Never store the saw with any fuel remaining in the tank, fuel lines, or carburetor! Your Shindaiwa warranty does not include coverage for damage caused by "stale" or contaminated fuels!

- Remove the spark plug, and then pour 7.4 ml of 2-cycle mixing oil into the cylinder through the spark plug

hole. Before reinstalling the spark plug, slowly pull the recoil starter 2-3 times to distribute the oil over the cylinder walls.

- Remove, clean, and reinstall the air filter element as described under "Daily Maintenance."
- Repair or replace any damaged components as required, and then store the unit in a clean, dry, dust-free area.
- Protect the chain by using a chain cover.

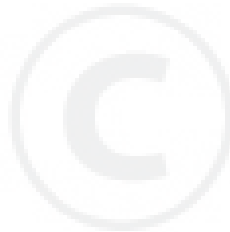

Saw Chain Performance

Your saw's performance on the job depends heavily on the condition of its saw chain.

How the Saw Chain Works

As the saw chain is pulled through the wood:

1. The depth gauge setting determines the depth of cut for each cutter.
2. The cutter's leading edge enters the wood, causing the entire cutter to "rock back" and lift away from the bar.

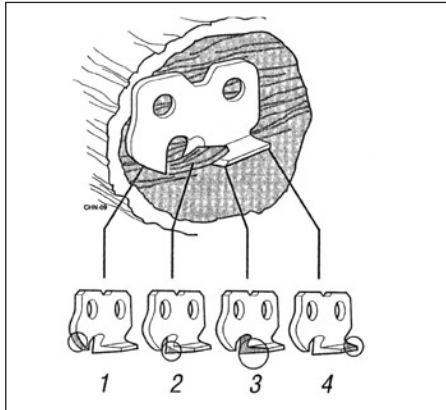

3. The top plate peels the severed wood chip away.
4. The chip is discharged out the rear of the cutter.

IMPORTANT!

Most of the actual cutting is done by the sides and corners of the individual cutters!

Sharpening Technique

1. Using the appropriate round file, sharpen all cutters to a 35° angle as shown.

IMPORTANT!

File all cutters to the same angle and depth! Unequal filing may cause the saw to vibrate or cut erratically!

NOTE:

For consistent filing angles, use a filing guide.

2. After all cutters are sharpened, use a depth gauge joiner to measure the height of each depth gauge.
3. As required, use a flat file to lower depth gauges to the appropriate 0.64 mm height.
4. After all depth gauges have been adjusted, use a flat file to round each depth gauge leading edge to original curvature and angle.

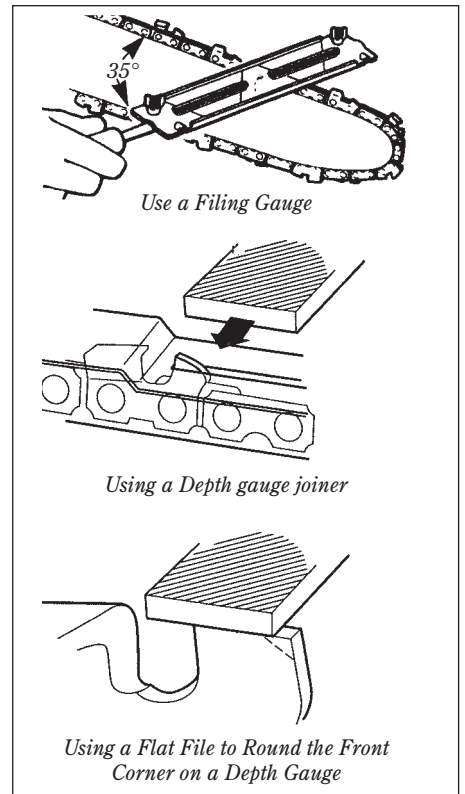

Correct Filing Technique

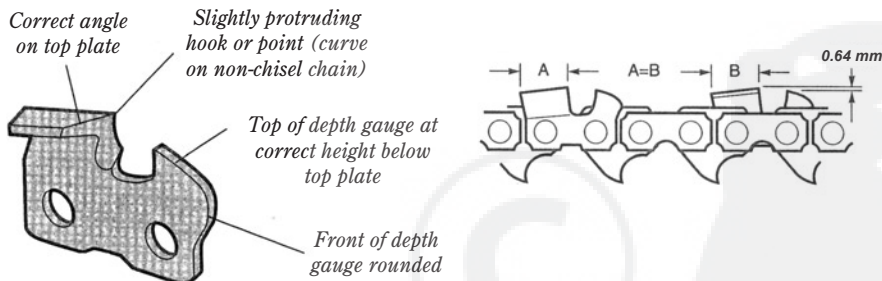

Filing Problems

Top plate angle less than recommended

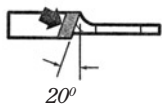

Cause
File held at less than recommended angle.

Result
Slow cutting. Requires extra effort to cut.

Remedy
File cutters to recommended angle.

Top plate angle more than recommended

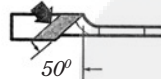

Cause
File held at more than recommended angle.

Result
Cutting angle is very sharp but will dull fast. Cutting action rough and erratic.

Remedy
File cutters to recommended angle.

High depth gauge



Cause
Depth gauge never filed.

Result
Slow cutting. Must force chain to cut. Will cause excessive wear on the cutter heel.

Remedy
Lower gauges to recommended setting.

Hook in side plate cutting edge



Cause
File held too low or the file was too small.

Result
Rough cutting. Chain grabs. Cutters dull quickly or won't hold a cutting edge.

Remedy
Check file size. File cutters to recommended angle.

Backslope on side plate cutting edge



Cause
File held too high or the file was too large.

Result
Cutters won't feed into wood. Slow cutting. Must force chain to cut. Causes excessive bottom wear.

Remedy
File cutters at recommended angle. Check file size.

Low depth gauge



Cause
Wrong gauge setting or no gauge used.

Result
Rough cutting. Chain grabs. Saw won't pull chain through wood. Excessive wear on the cutter heel.

Remedy
If depth gauges are too low, the chain is no longer serviceable.

Troubleshooting Guide

ENGINE DOES NOT START

What To Check	Possible Cause	Remedy
Does the engine crank? YES ↓	NO → Faulty recoil starter. Fluid in the crankcase. Internal damage.	Consult with an authorized servicing dealer.
Good compression? YES ↓	NO → Loose spark plug. Excess wear on cylinder, piston, rings.	Tighten and re-test. Consult with an authorized servicing dealer.
Does the tank contain fresh fuel of the proper grade? YES ↓	NO → Fuel incorrect, stale, or contaminated; mixture incorrect.	Refill with fresh, clean unleaded gasoline with a pump octane of 87 or higher mixed with 50:1 Shindaiwa Premium 2-cycle mixing oil or with an equivalent high quality 2-cycle mixing oil.
Is fuel visible and moving in the return line when priming? YES ↓	NO → Check for clogged fuel filter and/or vent.	Replace fuel filter or vent as required. Restart.
Is there spark at the spark plug wire terminal? YES ↓	NO → The ignition switch is in "O" (OFF) position. Shorted ignition ground. Faulty ignition unit.	Move switch to "I" (ON) position and restart. Consult with an authorized servicing dealer.
Check the spark plug.	If the plug is wet, excess fuel may be in the cylinder. The plug is fouled or improperly gapped. The plug is damaged internally or of the wrong size.	Crank the engine with the plug removed, reinstall the plug, and restart. Clean and regap the plug to 0.6 mm. Restart. Replace the plug with a NGK BPMR7A. Restart

LOW POWER OUTPUT

What To Check	Possible Cause	Remedy
Is the engine overheating?	Operator is overworking the unit. Carburetor mixture is too lean. Improper fuel ratio. Fan, fan cover, cylinder fins dirty or damaged. Carbon deposits on the piston or in the muffler.	Cut at a slower rate. Consult with an authorized servicing dealer. Refill with fresh, clean unleaded gasoline with a pump octane of 87 or higher mixed with 50:1 Shindaiwa Premium 2-cycle mixing oil or with an equivalent high quality 2-cycle mixing oil. Clean, repair or replace as necessary. Consult with an authorized servicing dealer.
Engine is rough at all speeds. May also have black smoke and/or unburned fuel at the exhaust.	Clogged air cleaner element. Loose or damaged spark plug. Air leakage or clogged fuel line. Water in the fuel. Piston seizure. Faulty carburetor and/or diaphragm.	Clean or replace the air filter. Tighten or replace the plug with a NGK BPMR7A. Restart. Repair or replace fuel filter and/or fuel line. Refill with fresh fuel/oil mixture. Consult with an authorized servicing dealer.
Engine is knocking.	Overheating condition. Improper fuel. Carbon deposits in the combustion chamber.	See above. Check fuel octane rating; check for presence of alcohol in the fuel. Refuel as necessary. Consult with an authorized servicing dealer.

Troubleshooting Guide (continued)

ADDITIONAL PROBLEMS

Symptom	Possible Cause	Remedy
Poor acceleration.	<ul style="list-style-type: none"> Clogged air filter. Clogged fuel filter. Chain brake engaged. Lean fuel/air mixture. Idle speed set too low. 	<ul style="list-style-type: none"> Clean or replace the air filter. Replace the fuel filter. Inspect and/or test brake. Consult with an authorized servicing dealer. Consult with an authorized servicing dealer. Adjust: 2,800 RPM min⁻¹.
Engine stops abruptly.	<ul style="list-style-type: none"> Switch turned off. Fuel tank empty. Clogged fuel filter. Water in the fuel. Shorted spark plug or loose terminal. Ignition failure. Piston seizure. 	<ul style="list-style-type: none"> Reset the switch and restart. Refuel. See page 8. Replace fuel filter. Drain; replace with clean fuel. See page 8. Clean or replace spark plug with a NGK BPMR7A, Tighten the terminal. Replace the ignition unit. Consult with an authorized servicing dealer.
Engine difficult to shut off.	<ul style="list-style-type: none"> Ground (stop) wire is disconnected, or switch is defective. Overheating due to incorrect spark plug. Overheated engine 	<ul style="list-style-type: none"> Test and replace as required. Replace spark plug with a NGK BPMR7A. Idle engine until cool.
Chain rotates at idle speed.	<ul style="list-style-type: none"> Engine idle too high. Broken clutch spring or worn clutch spring boss. 	<ul style="list-style-type: none"> Set idle: 2,800 RPM min⁻¹. Replace spring/shoes as required, check idle speed.
Excessive vibration.	<ul style="list-style-type: none"> Warped or damaged sprocket, chain, or bar. Bent crankshaft. 	<ul style="list-style-type: none"> Inspect and replace chain components as required. Consult with an authorized servicing dealer.

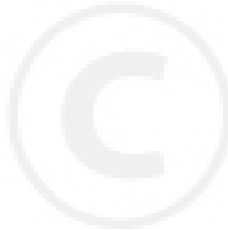

DECLARATION OF CONFORMITY

We hereby declare the Shindaiwa Engine Chain Saw,
Model E488 (488/EC1).

meets the following respective requirements.

Council Directives:	Standard taken:
89/336/EEC as amended	EN 292 parts 1&2
98/37/EC as amended	EN 608 & ISO 11681-1
2000/14/EC as amended	CISPR 12
2004/26/EC as amended	

Measured sound power level: 110dB(A)
Guaranteed sound power level: 111dB(A)

Notified Body:
Lloyd's Register, 71 Fenchurch Street, London EC3M 4BS UK
Storage No.: 0038/MCY/20030004/A

Technical documentation is kept by:
K. Maeda DIV. Manager
Engineering Research and Development DIV.

Shindaiwa Kogyo Co., Ltd.

Head office: 6-2-11, Ozuka—Nishi, Asaminami—Ku,
Hiroshima, 731—3167, Japan
TEL: 81-82-849-2003, FAX: 81-82-849-2482

6th May, 2005

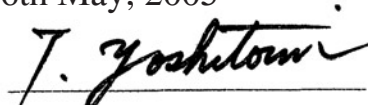

T. Yoshitomi
DIV. Manager
Quality Assurance DIV.

Shindaiwa Kogyo Co., Ltd.

Head office: 6-2-11, Ozuka—Nishi, Asaminami—Ku,
Hiroshima, 731—3167, Japan
TEL: 81-82-849-2206, FAX: 81-82-849-2481

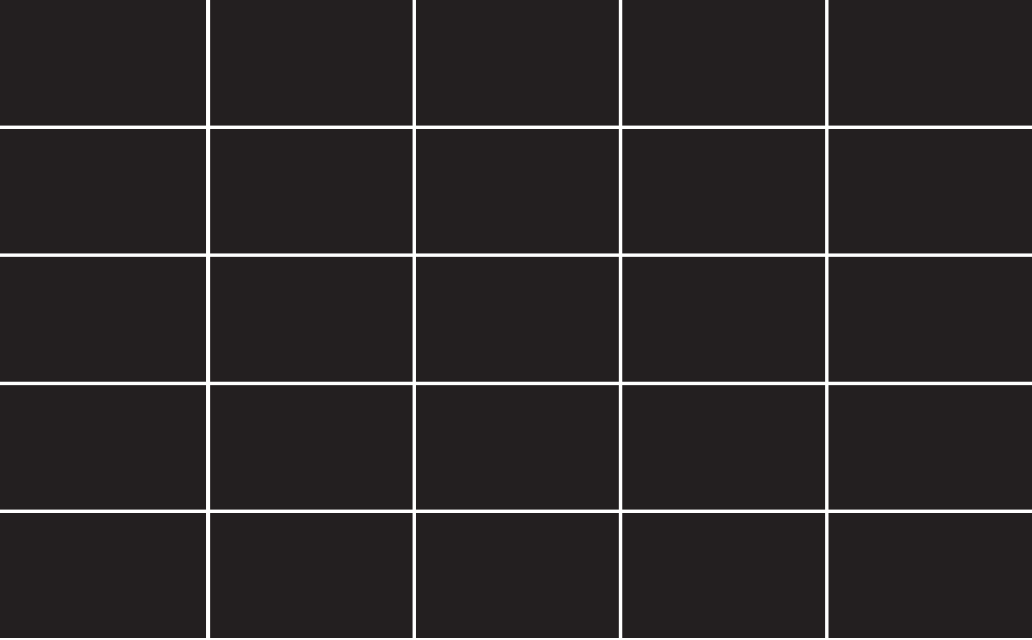

shindaiwa

Shindaiwa Inc.
11975 S.W. Herman Rd.
Tualatin, Oregon 97062 USA
Telephone: 503 692-3070
Fax: 503 692-6696
www.shindaiwa.com

Shindaiwa Kogyo Co., Ltd.
Head Office:
6-2-11, Ozuka-Nishi
Asaminami-Ku, Hiroshima
731-3167, Japan
Telephone: 81-82-849-2220
Fax: 81-82-849-2481

©2005 Shindaiwa, Inc.
Part Number 69026-94310
Revision 3/05

Shindaiwa is a registered trademark
of Shindaiwa, Inc.
Specifications subject to change without notice.

