

shindaiwa

Backpack Brush Cutter

BP-25, BP-35

INSTRUCTION MANUAL

FOR YOUR OWN SAFETY, CAREFULLY READ
THIS INSTRUCTION MANUAL BEFORE USE.

CAUTION:

Always wear eye protection when operating this machine.

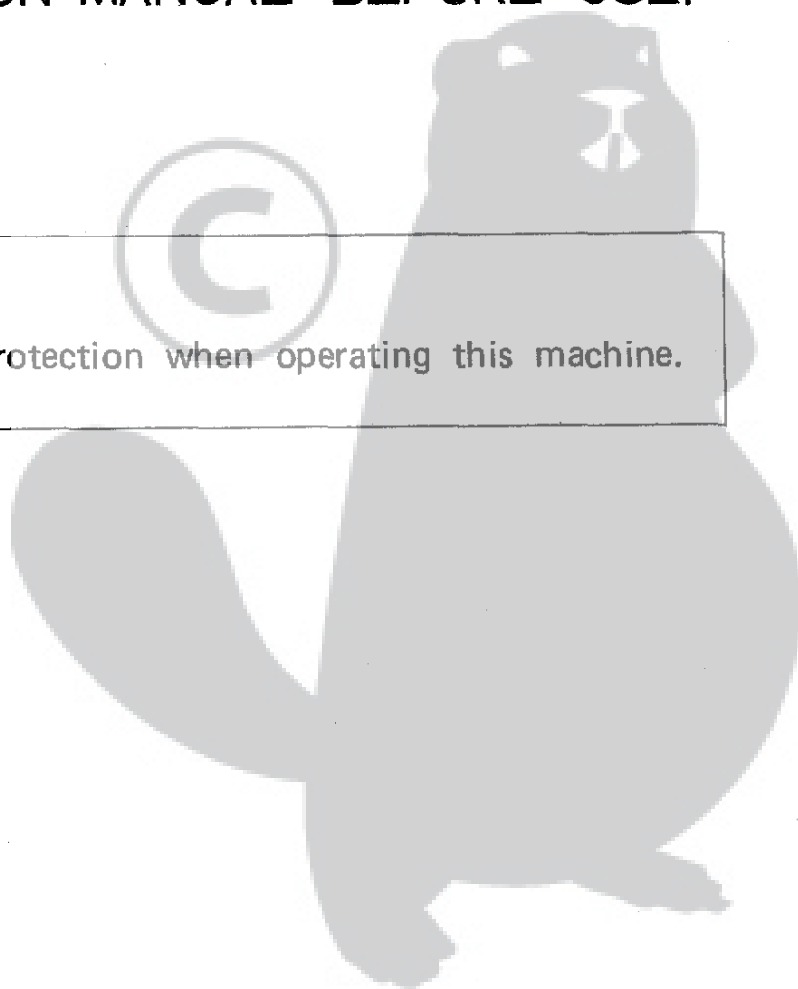

CONTENTS

A.	DESIGNATION OF VARIOUS PARTS	3
B.	TECHNICAL SPECIFICATIONS	4
C.	ASSEMBLY PROCEDURES	6
C-1	Installation of flex cable	6
C-2	Mounting of front handle	7
C-3	Mounting of throttle cable	8
C-4	Connection of grounding cord	8
C-5	Mounting of safety guard	9
C-6	Mounting of saw blade	9
D.	STARTING, STOPPING AND ADJUSTMENT OF ENGINE	10
D-1	Fuel filling	10
D-2	Starting procedure	10
D-3	To stop	12
D-4	Adjustment of engine	12
E.	PREPARATION AND OPERATION	13
E-1	Adjustment of exhaust direction	13
E-2	Adjustment of strap	13
E-3	Cutting procedures	14
F.	MAINTENANCE AND ADJUSTMENT	15
F-1	Routine maintenance	15
F-2	50-Hour maintenance	15
F-3	100-Hour maintenance	16
F-4	Sharpening of blade	16
G.	LONG-TERM STORAGE	17

H.	SAFETY INSTRUCTIONS	18
H-1	Apparel	18
H-2	Weather	18
H-3	Fire	18
H-4	Preliminary inspection	18
H-5	During operation	18
I.	TROUBLE SHOOTING	19
I-1	Engine will not start	19
I-2	Insufficient power	20
I-3	Poor acceleration	21
I-4	Engine stops during operation	21
I-5	Engine is difficult to shut off	22
I-6	Brush cutter main body	22

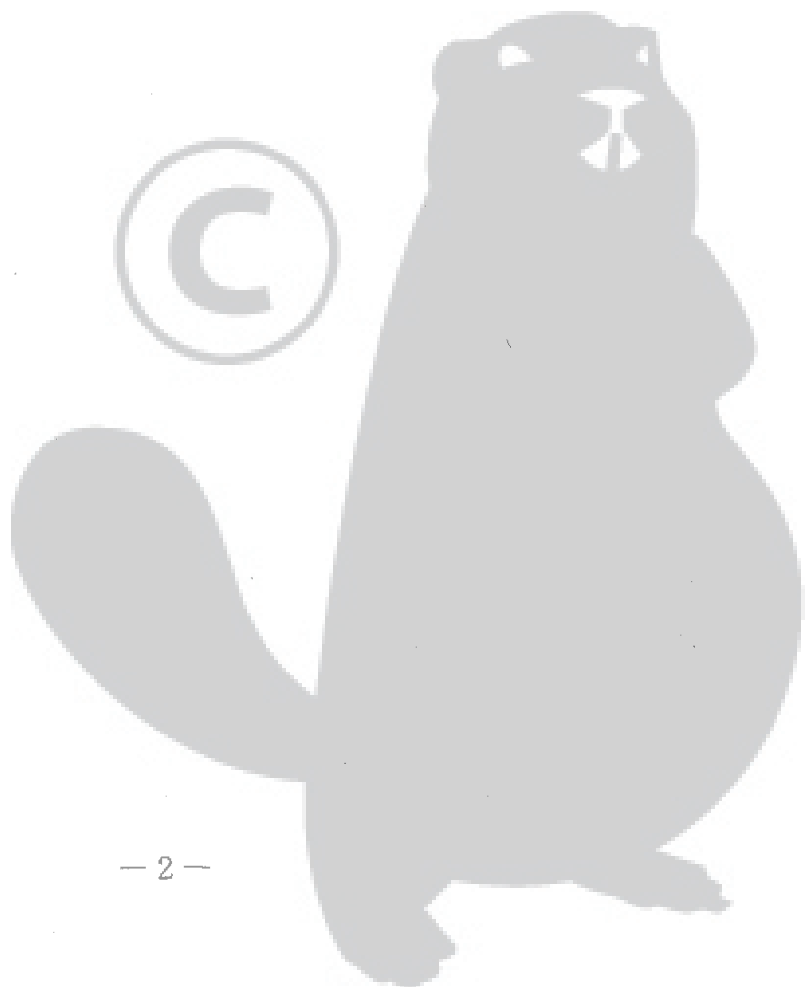

A. DESIGNATION OF VARIOUS PARTS

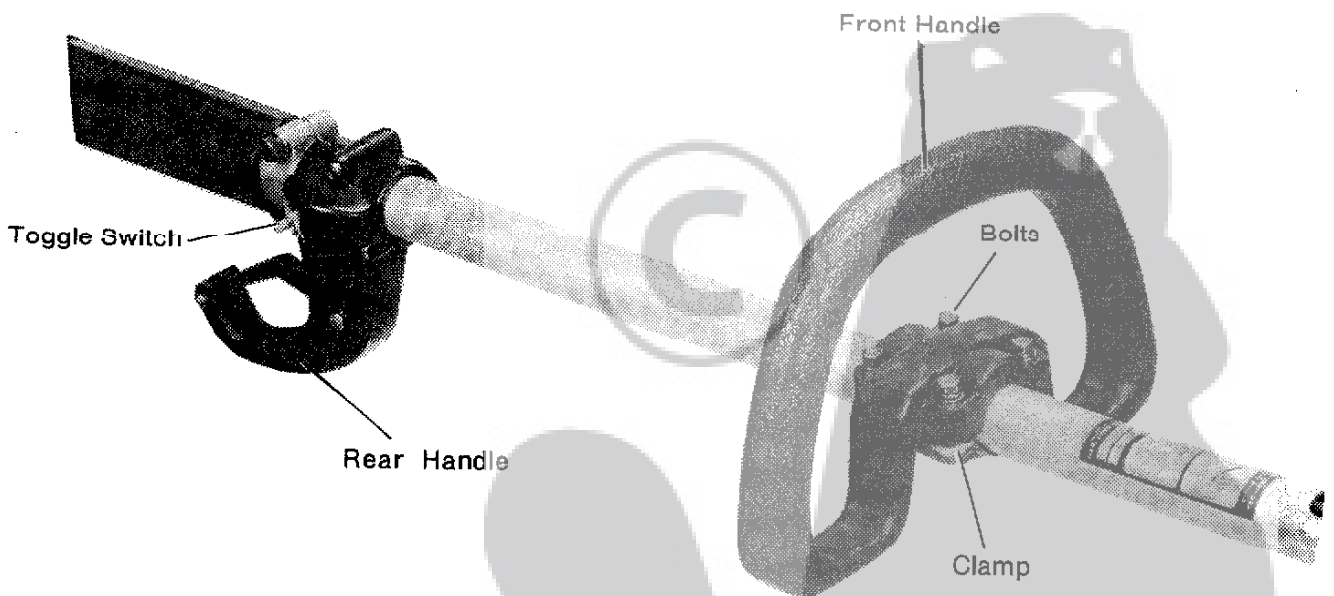
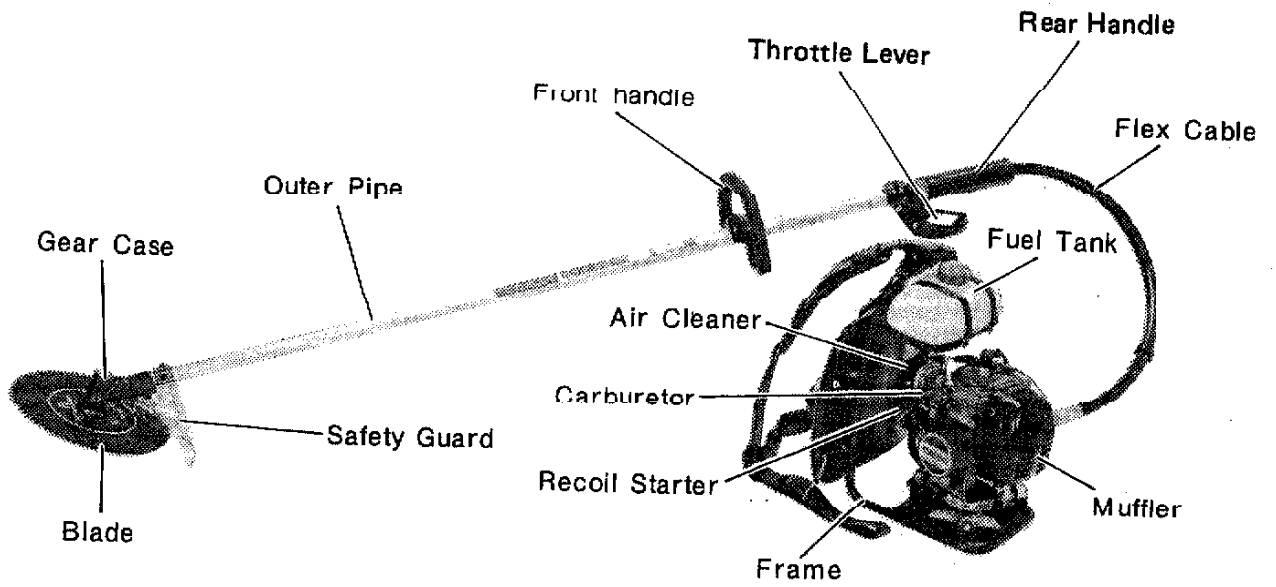

B. TECHNICAL SPECIFICATIONS

ITEM	MODEL	BP-25
Transmission		Centrifugal clutch, flex cable, spiral bevel gear
Gear reduction		1.286
Operating range		4800 ~ 7000 rpm
Rotation		Counter clockwise (from top)
Dry weight		
Engine		5.3 kg (less backpack band, fuel)
Lower unit		3.1 kg (less blade, safety guard)
Engine dimensions		290 mm x 300 mm x 410 mm
Lower unit length		2230mm
Engine		
Engine model		SK25F
Type		2 cycle air-cooled industrial
Bore x Stroke		32 mm x 30 mm
Displacement		24.1 cc/1.5 cu.in.
Horse power		1.4 HP/7500 rpm
Fuel capacity		1.2 l
Ignition		Electronic
Carburetor		Float
Cooling		Forced-air
Muffler		Enclosed, soft tone type
Spark plug		Champion CJ-8
Starter		Recoil starter
Stopping		Toggle type switch
Air cleaner		Semi-wet, silent type
Features – Standard		Steel saw blade 9", 80 tooth Anti-vib. engine mountings/backpack Safety guard Blade cover Outer pipe – swivel mechanism Front and rear handles Tool set

Specifications subject to change without notice.

ITEM	MODEL	BP-35
Transmission		Centrifugal clutch, flex cable, spiral bevel gear
Gear reduction		1.235
Operating range		4500 ~ 7000 rpm
Rotation		Counter clockwise (from top)
Dry weight		
Engine		6.0 kg (less. backpack band, fuel)
Lower unit		3.7 kg (less. blade, safety guard)
Engine dimensions		320 mm x 300 mm x 410 mm
Lower unit length		2360 mm
Engine		
Engine model		SK35F
Type		2 cycle air-cooled industrial
Bore x Stroke		36 mm x 33 mm
Displacement		33.6cc/2.1 cu.in.
Horse power		1.8 HP/7500 rpm
Fuel capacity		1.2 l
Ignition		Electronic
Carburetor		Float
Cooling		Forced-air
Muffler		Enclosed, soft tone spark arrestor type
Spark plug		Champion CJ-8
Starter		Recoil starter
Stopping		Toggle type switch
Air cleaner		Semi-wet, silent
Features – Standard		Steel saw blade 10", 80 tooth Anti-vib. engine mountings/backpack Safety guard Blade cover Outer pipe — Swivel mechanism Front and rear handles Tool set

Specifications subject to change without notice.

CAUTION:

Always wear eye protection when operating this machine. ANY BRUSH BLADE CAN NOT BE USED FOR CUTTING TREE.

C. ASSEMBLY PROCEDURES

Assemble engine, handles, safety guard, flex cable and blade, each packed in disassembled state, in the following proper order.

C-1 Installation of flex cable

1. Remove screw on rear hand grip and install flex cable.

Be sure to install the O-ring side of flex cable. Tighten screw securely.

Note : Be sure to set groove on outer pipe circumference to come in line with the hole on flex cable when tightening.

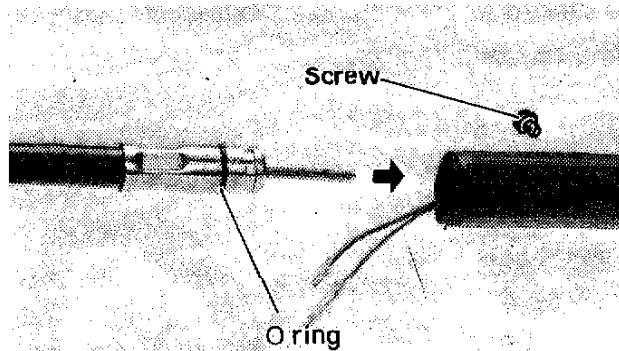

2. Put the flex cable through cable holder hole.

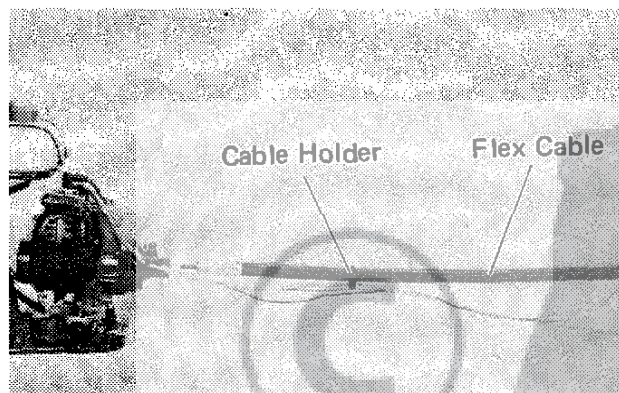

3. Connect flex cable to engine.

Note: Lock knob does not need to be pulled for installation.

Check proper lock knob position by pulling on assembly.

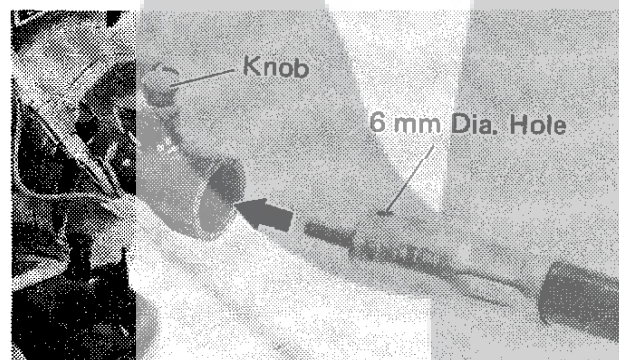

C-2 Mounting of front handle

Front handle is disassembled at shipment. Please assemble according to following procedures.

1. Loosen four clamp bolts, attached to front handle turning counterclockwise, and remove clamp.
2. Mount front handle on outer pipe upper part with calmp and tighten clamp bolts securely, turning clockwise.

Note : Label is sticked to show handle position on outer pipe but adjust the position depending on condition used.

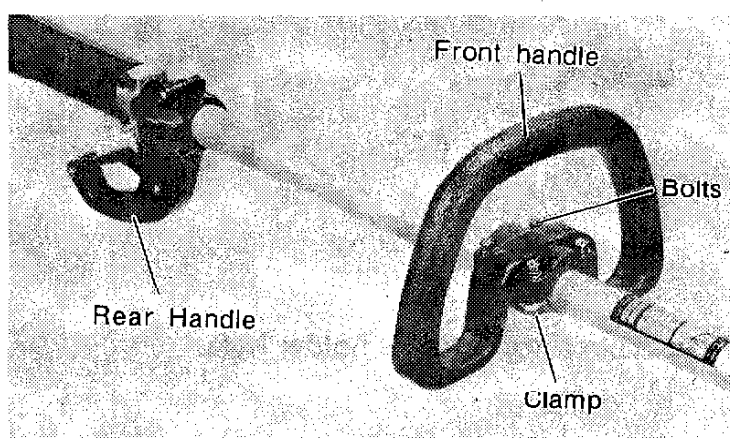

C-3 Mounting of throttle cable

1. Remove cable guide attached to throttle lever.
2. Loosen two screws which tighten throttle lever to outer pipe.
3. Shift throttle lever toward to saw blade.
4. Thrust throttle cable through hole in rear grip.
5. Set cable guide on throttle lever with slit of cable guide facing bottom side and throttle cable coming into the slit.
6. Shift throttle lever back into original position and tighten two screws securely.

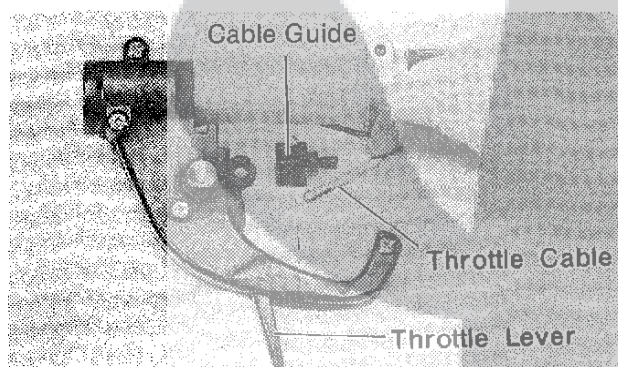

7. Remove protective cover and secure in place using lock nut so that the slack of throttle lever is about .20 – .40" (5 – 10 mm) with adjusting nut.

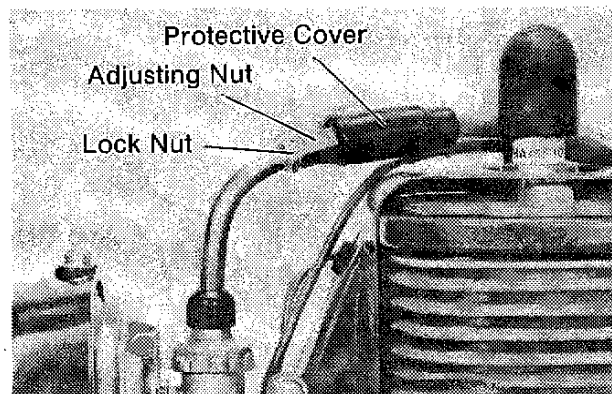

C-4 Connection of grounding cord

Connect the grounding cords – one from rear grip and the other from throttle cable. (Connect the same color cords.)

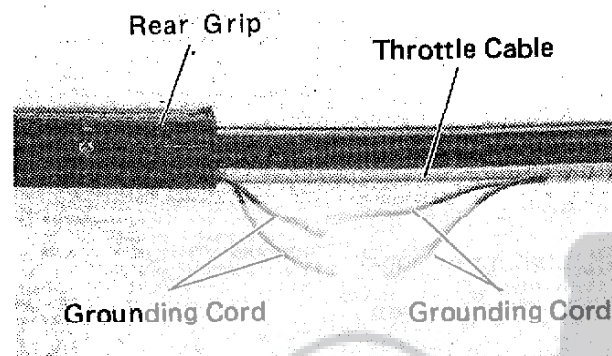

C-5 Mounting of safety guard

1. Loosen clamp bolts attached to safety guard.
2. Mount on outer pipe with clamp aligned to the end of gear case as seen in the photo.
3. Tighten clamp bolts securely adjusting so that guard will level horizontally.

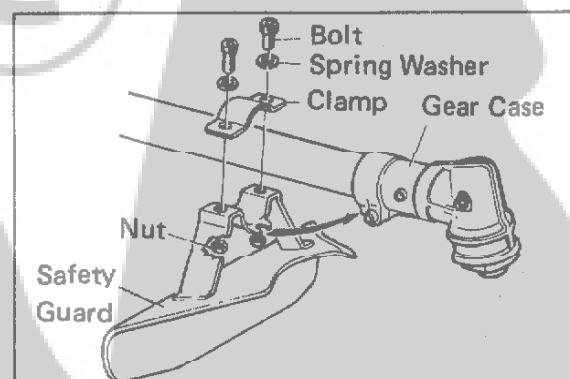

C-6 Mounting of saw blade

1. Set saw blade in place as shown in sketch. Slide safety clip to direction shown; install saw blade, then return safety clip to original position. (See illustration.)

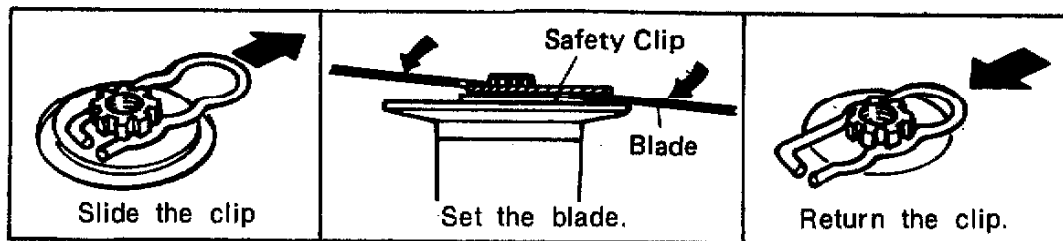
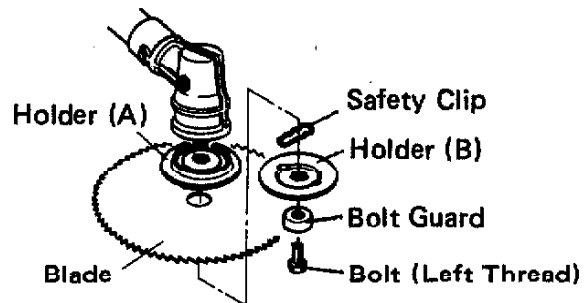

2. Install cutter holder (B), bolt guard, bolt in order. Secure holder (B) with spanner and tighten bolt with plug wrench. (Be sure that the slide pin is returned to the original position; otherwise the holder (B) can not be tightened properly.)

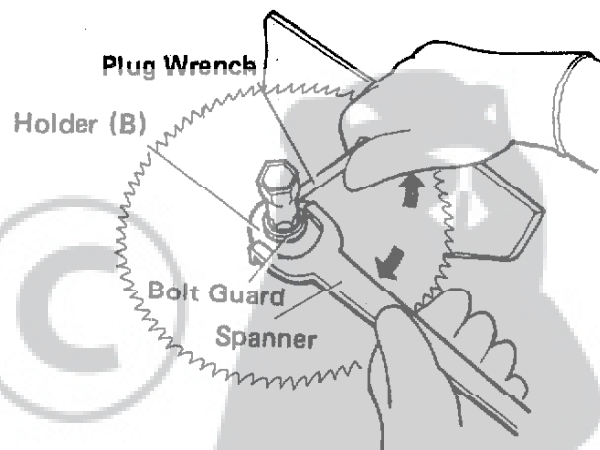

D. STARTING, STOPPING AND ADJUSTMENT OF ENGINE

D-1 Fuel filling

Use fuel with a gas/oil ratio of 25 : 1.

CAUTION:

1. Always use 2-cycle oil.
2. Add and mix fuel in a safe place.
3. Saw blade will turn when engine starts. Check surrounding area as a precautionary measure.

D-2 Starting procedure

1. When engine is cold;

1 Put the switch "ON" position.

2 Open fuel cock.

3 Close choke lever.

4 Pull throttle lever into starting position with lock knob on set position.
(Throttle lock will disengage when depressed again.)



- 5 Be sure that saw blade does not touch ground. Place left hand on engine and pull starter rope with right hand as shown in photo. Pull slowly until starter pawl engagement (more resistance) is felt, then pull briskly until engine starts.

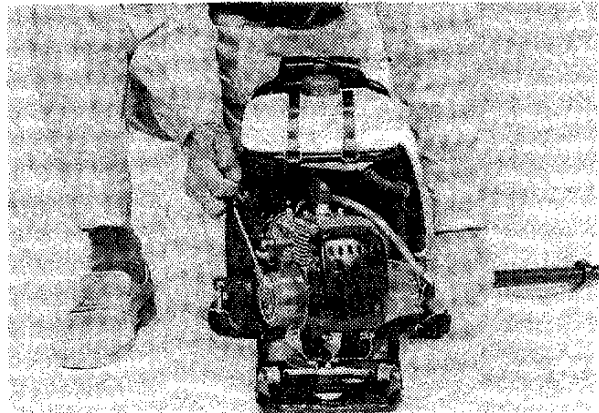

CAUTION:

Do not pull cord to end as it shortens service life significantly.

- 6 When engine first fires or coughs, gradually return choke lever to open position.

* If engine stops before choke is fully open, restart with choke closed.

* If engine stops after initial firing, restart with choke open.

When engine starts, return to idle by pulling throttle lever to release lock.

CAUTION:

When engine starts, saw blade rotates. Be sure to check surrounding area and lift blade up from ground before starting.

2. When starting a warm engine;

- 1 Put the switch "ON" position.
- 2 Open fuel cock.
- 3 Place throttle lever in starting position by opening throttle and depressing throttle lock.
(Throttle lock will disengage when depressed again.)
- 4 Pull recoil starter.

CAUTION:

Repeated prolonged cranking with choke closed will cause flooding.
Restart with choke lever open.

(See item  on previous page.)

After engine starts allow it to warm up at low RPM for 2 – 3 minutes.

D-3 To stop

1. Release throttle lever;
reducing RPM to a slower speed.
Allow engine to idle for a short period.
2. Put “toggle switch” to OFF
position, and close fuel cock.

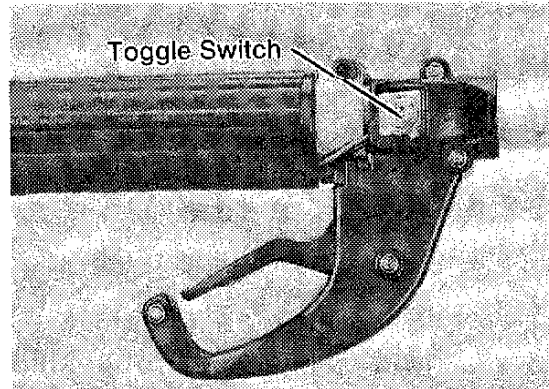

D-4 Adjustment of engine

After starting, allow engine to warm up at low speed for 2 – 3 minutes.

Adjust idle speed so that stable RPM is achieved with throttle closed.

Idle adjustment screw

Turn to right (clockwise) to increase RPM and turn to left (counter clockwise) to decrease RPM.

CAUTION:

Adjustment should be made so that clutch disengages at low RPM, resulting in stoppage of saw blade.

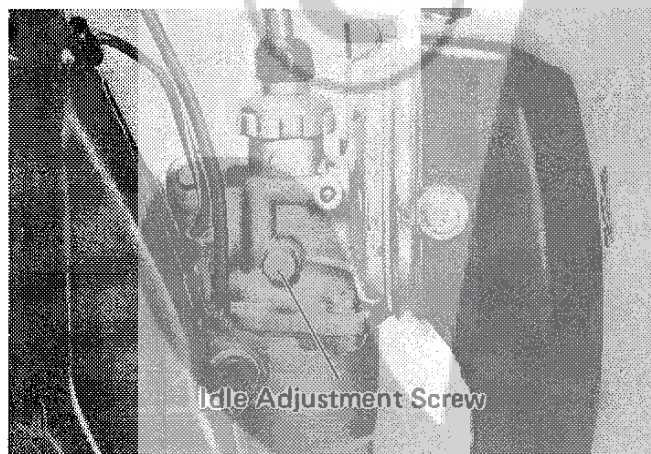

E. PREPARATION AND OPERATION

E-1 Adjustment of exhaust direction

The engine is mounted for right. Adjust the tail pipe direction for left hand side, if required, as shown in illustration.

Loose the screw and rotate the tail pipe.

Fasten the screw after adjustment.

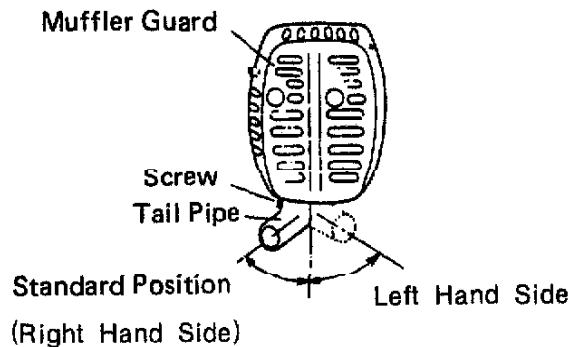

E-2 Adjustment of strap

1. Hold outer pipe with right hand and grasp strap in left hand. Swing unit to shoulder.



2. Hold outer pipe with left hand and place strap on right shoulder.

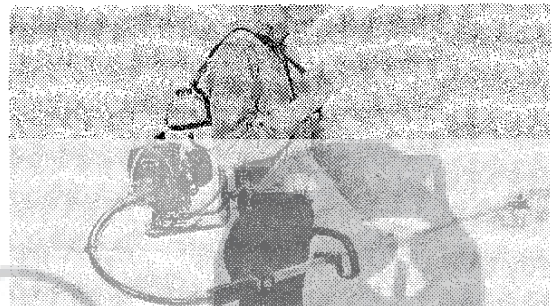

3. Connect the bands.
Tighten and adjust as necessary.



4. Adjust unit backpack rests comfortably on lower back.

E-3 Cutting procedures

1. Start engine and increase RPM by depressing throttle lever. Saw blade will begin to rotate as RPM increases.
2. When throttle lever is released, centrifugal clutch is disengaged and blade rotation stops (Engine at idle).

3. As the saw blade rotates in counter-clockwise direction, it is more efficient to cut from right to left. (As clippings are deposited at left hand side, it is recommended to advance cutter from left side, so that clippings are clear of the next row).



4. The saw blade cuts most efficiently at about $\frac{1}{3}$ radius from the tip of the saw for cutting trees and $\frac{2}{3}$ radius for cutting grass.

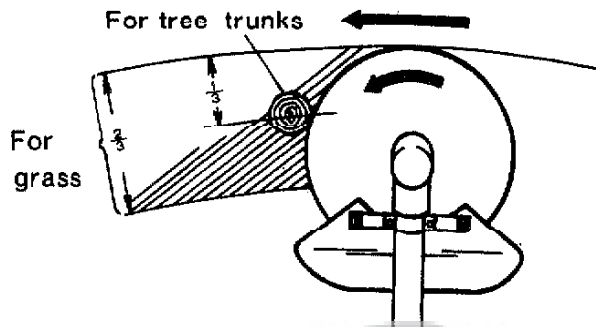

5. Do not allow the engine to run at high RPM with no load. Damage to the engine or main shaft may occur.
6. Though blade will rotate at relatively low RPM with clutch engaged, it is not recommended to operate in this condition as vibration will occur due to clutch chatter. This can lead to rapid wear of the clutch. Also, grass and leaves tend to coil around the blade.

CAUTION:

1. When cutting tree trunks feed the sawblade into the wood: Do not hit with a shock.
2. Allow no one within 10 m (30 feet) of the operator during operation.
3. Always operate with safety guard.
4. Always attach blade cover when transporting.

F. MAINTENANCE AND ADJUSTMENT

F-1 Routine maintenance

1. Remove all grass clippings and dirt from brush cutter. Check cooling fins and air cleaner for excessive clogging (clean if necessary).
2. Remove fuel tank and muffler and clean out debris. A build up of debris in this area can lead to over-heating, fire, and/or engine trouble. Keep it clean.
3. Check for loose or missing screws and components.
4. Check for leaking fuel or grease.

F-2 50-Hour maintenance

1. Remove cylinder cover and clean grass and debris from cylinder fins and cylinder cover. When reassembling carefully fit cylinder over crankcase.

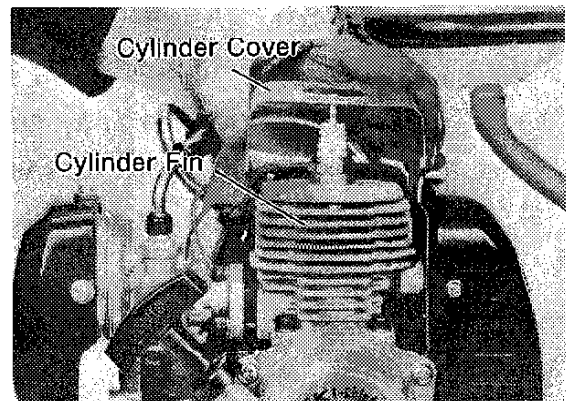

2. Remove and clean spark plug. Adjust gap to 0.6 mm (0.025"). When replacing plug, only use the one recommended by SHINDAIWA.

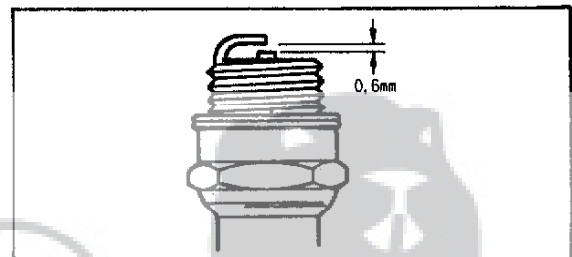

3. Remove air cleaner element from carburetor and clean with mixed oil. Reassemble after squeezing out excess fuel.

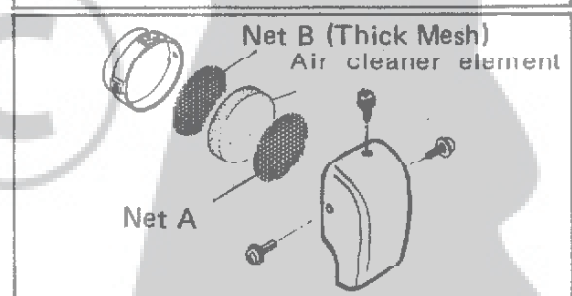

4. Refill gearcase with grease. Pull collar out of gear shaft and refill with new grease to push out old grease. Always use only the type of grease recommended for gearcase (Lithium type).

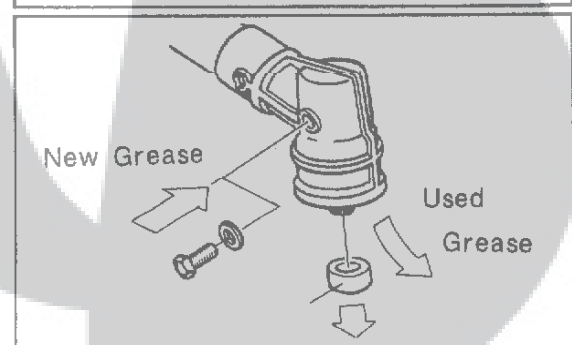

5. Grease on flex cable.

Always use only the recommended grease (Lithium type).

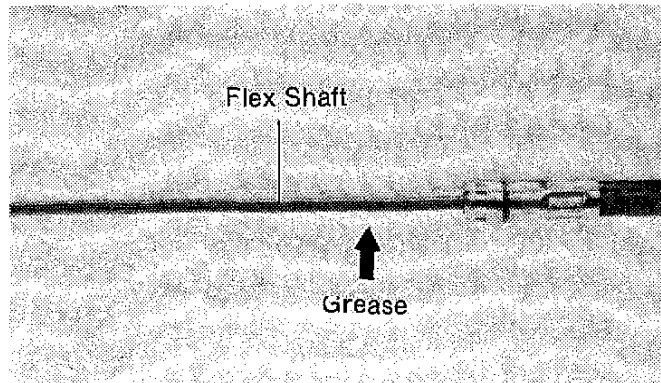

Pull flex cable out of rear grip and remove grease out of rear grip. Excessive grease may cause overheating.

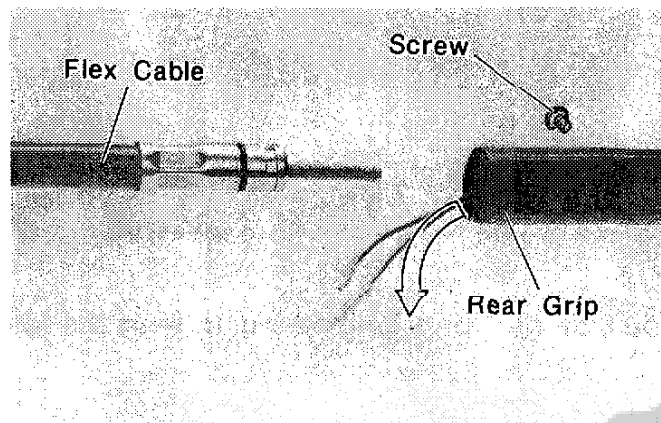

F-3 100-Hour maintenance

1. Check for missing or loose components.
2. Check for grease between clutch shoe and drum. If present, wipe off with unleaded gasoline.

F-4 Sharpening of blades

1. Circular saw blade
(See illustrations)
* Leave radius with files.
* Blade must have set.

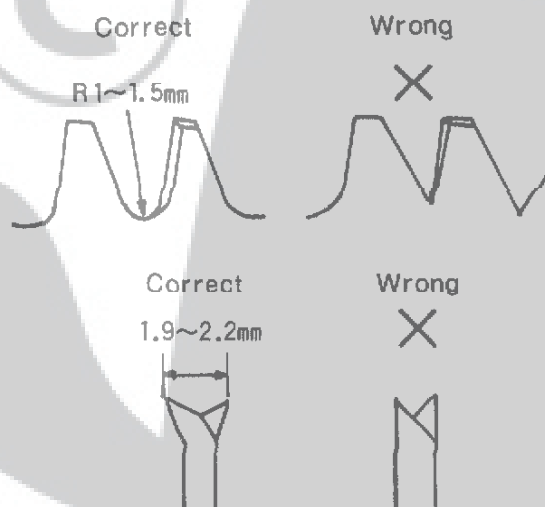

2. 8-tooth grass cutting blade (brush blade)

(See illustrations)

* Leave radius at base of tooth.

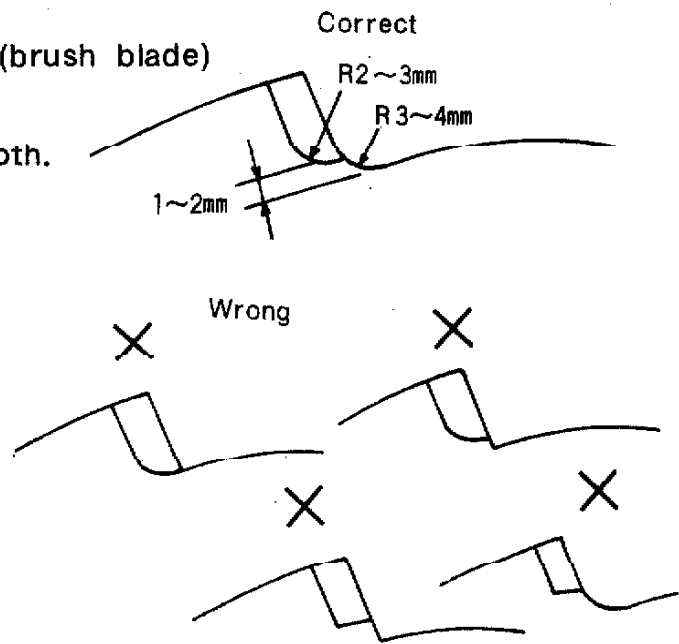

G. LONG-TERM STORAGE

When the unit won't be run for a long period, observe the following storage procedures:

1. For prevention of rust, clean all external parts thoroughly and coat all metallic surfaces with a light coating of oil.
2. Drain all fuel from carburetor and fuel tank.
3. Remove spark plug and pour a small quantity of oil through spark plug hole. Pull recoil starter rope 2 – 3 times to uniformly coat interior of engine. Replace spark plug.
4. If any damage is found, repair it before storage.
5. Store brush cutter in clean dry dust free area.

H. SAFETY INSTRUCTIONS

For safer operation, always observe the following precautions:

H-1 Apparel

1. Wear a long-sleeved jacket and long pants. Wearing unbuttoned or floppy jackets are dangerous.
2. Wear a broad-brimmed hat or helmet when operating on a slope.
3. Wear non-skid (lug soled) boots or shoes.

H-2 Weather

In extremely hot or cold weather, avoid long term operation. Also, use extreme care if work must be done in rainy weather; due to slippery terrain.

H-3 Fire

1. As gasoline is present, do not smoke or light fires near brush cutter.
2. When refueling, always stop engine.

H-4 Preliminary inspection

1. Tighten saw blade fastening bolt firmly before operation.
2. Check saw blade for chipped teeth, cracks, or warpage. If found, DO NOT USE, replace with serviceable blade.
3. Rotate saw blade to check for abnormal vibration. If present, check to be sure saw blade has been properly fitted into cutter holder. If installed properly, replace blade with new one and recheck.
4. When saw blade fastening bolts or flanges have been worn to the point that spanner or wrench slips, replace with new parts.

H-5 During operation

1. Make sure no one is within 10 m (30 feet) during operation.
2. When operating in rocky terrain or near electric wires or fences, use extreme caution to avoid hitting the blade. If accidental contact is made, always stop engine and inspect blade for damage.
3. NEVER operate with guard removed.

I. TROUBLE SHOOTING

I-1 Engine will not start

Trouble	Possible cause	Remedy
Spark plug (No Spark)	<ol style="list-style-type: none"> 1. Electrode is wet or fouled. 2. Carbon deposit on electrode. 3. Cracked insulator. 4. Too small or large of electrode gap. 5. Burned electrode. 	<ol style="list-style-type: none"> 1. Dry plug. 2. Clean plug. 3. Replace plug. 4. Adjust gap to 0.6 mm (.024"). 5. Replace plug.
Ignition system (No Spark)	<ol style="list-style-type: none"> 1. Coil is burned out. 2. Coil insulation failure. 3. Break in coil wire. 4. Transistor unit is burned out. 	<ol style="list-style-type: none"> 1. Replace coil. 2. Replace coil. 3. Replace coil wire. 4. Replace unit.
With good compression, sufficient fuel (With Spark)	<ol style="list-style-type: none"> 1. Engine is flooded. 2. Excessive thick fuel. 3. Use of improper fuel. 	<ol style="list-style-type: none"> 1. Discharge fuel by cranking engine—choke off! 2. Adjust carburetor. 3. Drain and replace with proper fuel.
Sufficient fuel, poor compression. (With Spark)	<ol style="list-style-type: none"> 1. Excessive wear on cylinder, piston, rings. 2. Loose spark plug. 	<ol style="list-style-type: none"> 1. Inspect and replace all worn parts. 2. Tighten spark plug.
No fuel in carburetor (With Spark)	<ol style="list-style-type: none"> 1. No fuel in tank. 2. Loose fuel line fitting. 3. Clogged fuel line. 4. Fuel in tank does not reach carburetor. 5. Plugged air vent in fuel tank. 	<ol style="list-style-type: none"> 1. Refuel. 2. Inspect and tighten. 3. Clean or replace filter. 4. Refer to starting procedure p. 5. Clean vent.

H-2 Insufficient power

Trouble	Possible cause	Remedy
Blockages	<ol style="list-style-type: none"> 1. Clogged air filter . 2. Carbon build-up in muffler . 3. Air leakage in fuel pick-up tube fitting . 4. Fuel line/passage clogged . 5. Piston seizure . 6. Carburetor diaphragm is inoperative . 7. Water in fuel . 	<ol style="list-style-type: none"> 1. Clean . 2. Clean . 3. Tighten fitting . 4. Clean . 5. Examine for scoring, replace worn parts . 6. Replace diaphragm or carburetor . 7. Replace with clean fuel mix .
Overheating	<ol style="list-style-type: none"> 1. Excessively lean mixture . 2. Improper fuel mixing ratio . 3. Carbon deposits on piston . 4. Fan cover, cylinder fins, etc. plugged with dirt and debris . 5. Machine is overworked by operator . 	<ol style="list-style-type: none"> 1. Adjust carburetor . 2. Replace with proper 25:1 fuel mix . 3. Remove carbon . 4. Clean and remove dirt and debris . 5. Operate properly—DO NOT overload .
Engine makes knocking noise	<ol style="list-style-type: none"> 1. Cylinder overheating . 2. Use of improper fuel . 3. Carbon deposits in combustion chamber . 	<ol style="list-style-type: none"> 1. Adjust carburetor, clean cylinder fins . 2. Replace with proper fuel . 3. Clean combustion chamber .

I-3 Poor acceleration

Trouble	Possible cause	Remedy
Fuel system, clogged	<ol style="list-style-type: none">1. Fuel filter clogged .2. Excessively lean carburetor setting .3. Clogged air cleaner .4. Excessively low idle .	<ol style="list-style-type: none">1. Clean or replace .2. Adjust carburetor .3. Clean filter .4. Speed up idle .
Air leakage	<ol style="list-style-type: none">1. Loose carburetor .2. Loose fuel pick-up tube .	<ol style="list-style-type: none">1. Tighten securely .2. Insert firmly .

I-4 Engine stops during operation

Trouble	Possible cause	Remedy
Engine stops abruptly	<ol style="list-style-type: none">1. Switch is bumped .2. Loose spark plug wire .3. Piston is scored, indicating seizure .4. Shorting of spark plug due to carbon build-up .5. Failure of ignition system .	<ol style="list-style-type: none">1. Keep hands clear of switch .2. Replace .3. Repair or replace all worn parts .4. Clean spark plug .5. Disassemble and inspect .
Miscellaneous	<ol style="list-style-type: none">1. Fuel tank empty .2. Carburetor clogged .3. Fuel tank clogged .4. Water in fuel .	<ol style="list-style-type: none">1. Refuel .2. Disassemble and clean .3. Disassemble and clean vent .4. Replace with clean fuel mix .

I-5 Engine is difficult to shut off

Trouble	Possible cause	Remedy
Overheating	1. Overheated engine . 2. Overheated spark plug .	1. Run at idle . 2. Clean and adjust gap to 0.6 mm (.024") .
Electrical	1. Poor contact of ground wire . 2. Defective kill switch .	1. Inspect and correct . 2. Replace switch .

I-6 Brush cutter main body

Trouble	Possible cause	Remedy
Sawblade rotates with engine idling	1. Broken clutch spring . 2. Loose cutter holder .	1. Replace . 2. Tighten firmly .
Irregular vibration	1. Sawblade warped or damaged . 2. Bent main shaft . 3. Worn shaft bushings . 4. Loose gearcase .	1. Replace or reinstall . 2. Straighten or replace . 3. Replace . 4. Tighten bolt securely .



SHIN-DAIWA KOGYO CO., LTD. Shindaiwa Inc.