

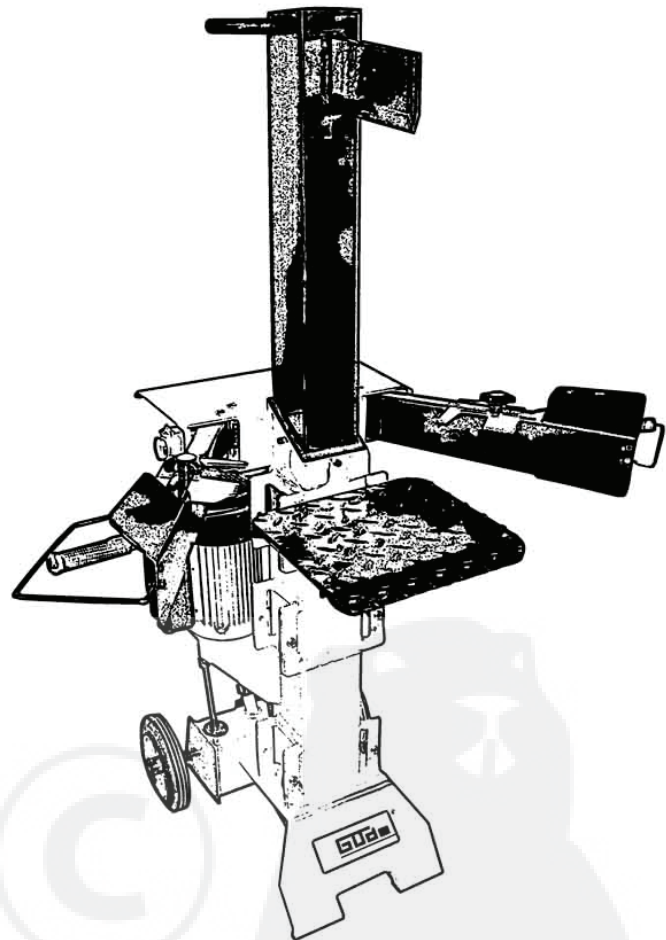

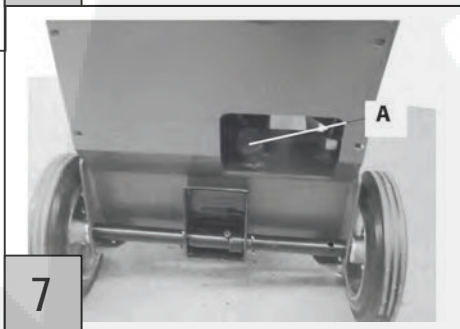

Deutsch	03
Nederlands	23
English	28
Français	33

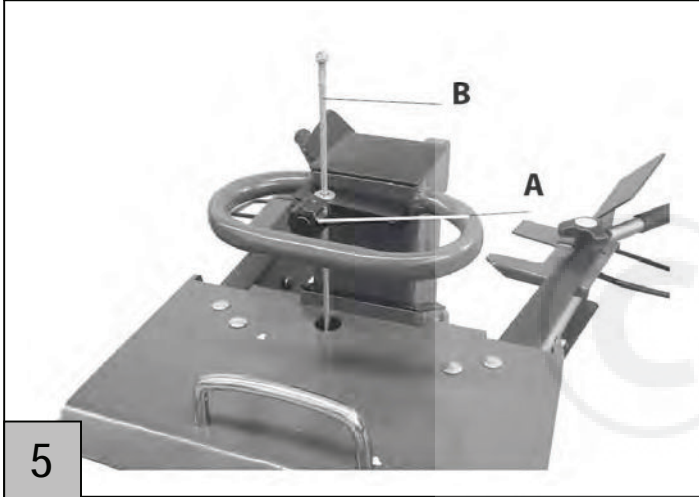

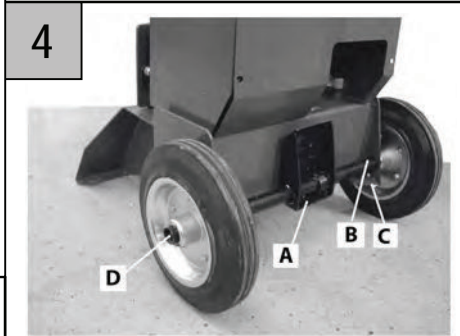
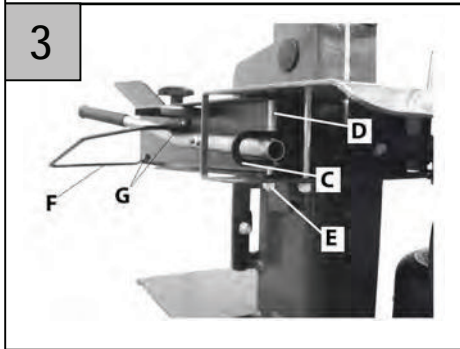
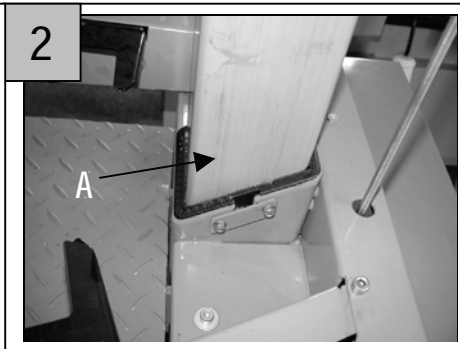
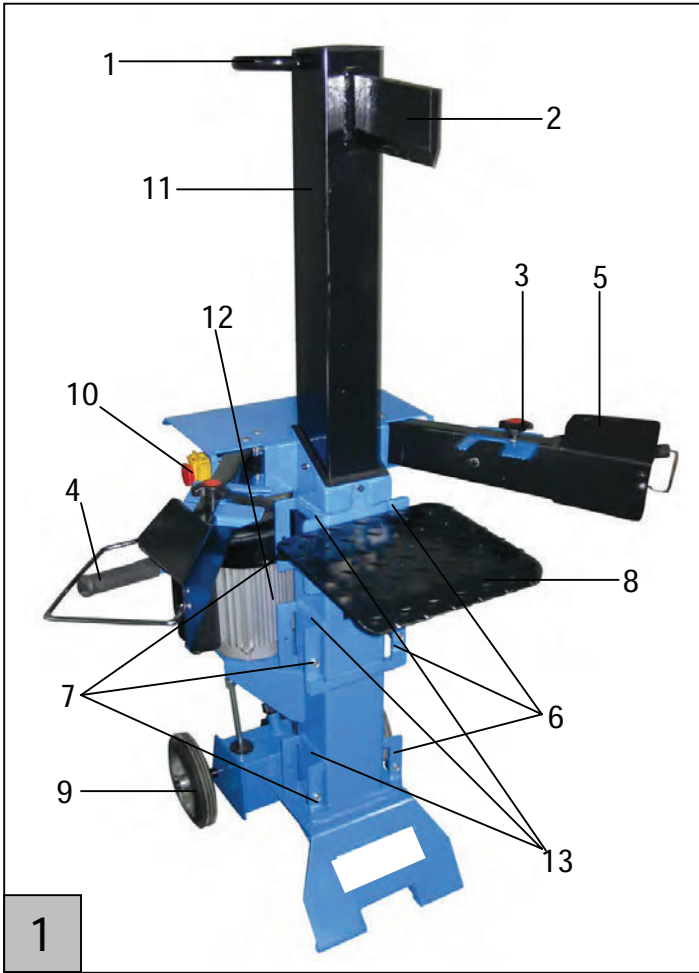

	<p>Thank you for purchasing the GreenStar wood splitter and the confidence in our products.</p> <p>!!! Please read carefully the Operating Instructions before putting the appliance into operation !!!</p>
---	---

A.V. 2

Any reprints, even partial, are subject to approval. Technical changes reserved! Pictures just for illustration purposes!

	<p>Do you have any technical questions? A claim? Do you need spare parts or the Operating Instructions? To be able to identify your appliance when claimed, we need to know its serial No., order No. and the year of production. All these details can be found on the type label. Enter the details below for future reference:</p>		
	Serial No.	Order No.	Year of production:

Marking on the appliance

Explanation of symbols
The following symbols are used in these Operating Instructions and/or on the appliance:

Product safety:

	
Product corresponds to appropriate standards of the EU	





Prohibitions:

	
General prohibition (in connection with another icon)	No smoking!
	
No open fire!	Using in enclosed places prohibited!



Warning:

	
Warning/attention	Warning against dangerous voltage
	
Keep a sufficient safe distance!	Warning! Risk of getting jammed!



Commands:

	
Read the Operating Instructions before use	Use protective glasses and earphones!
	
Use safety gloves	Use safety shoes!









Environment protection:

	
Dispose waste professionally so as not to harm the environment.	Packing cardboard material may be delivered to collecting centres for recycling.
	
Any damaged and/or disposed electric or electronic devices must be delivered to appropriate collection centres.	

Package:

	
Protect against humidity	This side up
	
Careful – fragile	

Technical data:

	
Connector	Engine power
	
Split wood length (with splitting cross)	Hydraulic pressure
	
Splitting lift	Split wood length (without splitting cross)
	
Splitting force	Weight

Appliance description (pic. 1)

1. Handle
2. Splitting knife
3. Clamping plate
4. Service arm
5. Handle covering
6. Table holder (in front)
7. Table blocking
8. Splitter table
9. Wheels
10. Switch / plug
11. Lift adjusting rod
12. Motor
13. Table holder (side)

Appliance

BASIC 6T/W WOOD SPLITTER
Robust design, splitting knife out of special steel, all steel parts with high-quality powder coating, high-quality hydraulic pump. Engine with overheating fuse.

 **EU Declaration of Conformity**
We, hereby declare the conception and construction of the below-mentioned appliances correspond - at the type of construction being launched - to appropriate basic safety and hygienic requirements of EC Directives.

In case of any change to the appliance not discussed with us the Declaration expires.
 Marking of appliances: GreenStar wood splitter
 Order No. GS-HLS8000V

Date/producer signature: Dec 30,2009

Appropriate EU Directives :
 2004/108/EG
 2006/95/EG
 2006/42/EG

Harmonised standards used:
 EN 609-1/A 2:2009
 EN 60204- 1/A1:2009
 EN 61000-3-11:2000
 EN 61000-3-2:2006
 EN 55014-2/A1:2001
 EN 61029-1/A12:2003
 EN 55014-1:2006
 ZEK 01.2-08
 Certification place:
 TÜV SÜD Product Service GmbH, Rindlerstrasse 65, DE-80339 Munich

Guarantee

The guarantee relates exclusively to faults caused by material defect or manufacturing defect.

Original proof of purchase with the purchase date needs to be attached for claims in the guarantee period.

The guarantee does not cover any unauthorised use such as appliance overloading, violent use, damage by third party or foreign items. The failure to follow the Operating Instructions and assembly instructions and ordinary wear and tear is not included in the guarantee.

Safety instructions

General

For safety reasons it is necessary to respect and follow safety instructions specified in these Operating Instructions and instructions on the appliance relating to appliance operation, maintenance and repairs.

Operating staff

Using the wood splitter can be associated with some risks. Therefore only trained and experienced persons can handle the appliance and work with it. The operating staff must wear tight, close-fitting clothing and protective shoes.

Workplace

To ensure safe wood splitting, it is necessary that the workplace is flat and enables stability keeping and sufficient free moving. All obstacles need to be removed from access paths when bringing the splitter and taking it away. Sufficient workplace lighting must be ensured.



Make sure no persons are present in the workplace during appliance operation or make sure they keep a sufficient safe distance.

Work preparation

Current supply needs to be interrupted by pressing the red button on the switch and disconnecting the plug at any repairs or maintenance work and when leaving the wood splitter. Interrupting the current supply by putting the switch to OFF position is not sufficient. GreenStar wood splitters are fundamentally supplied with hardened splitting knives. However, if you detect any slight deformation of the knife edge after splitting wood containing any invisible foreign particles, e.g. out of concrete, steel, etc. then remove it by a file or grinding stone. Keeping the splitting knife permanently sharp increases the working output.

TIP: Occasionally grease the splitting knife with fat (for problem wood).

The function of safety equipment (especially the two-lever operation) needs to be checked before the splitter is put into operation for the first time.

ATTENTION! Make sure the splitting table is safely secured to the splitter before the splitter is put into operation.

Technical data

Technical data:	Basic 6T/W
Connector:	230 V~50 Hz
Engine power:	3,0 kW P1/ S6 40%
Engine revolutions:	2800 revolutions a minute
Max. splitting force:	6 tons
Max. splitting lift:	485 mm
Forward feed rate:	4-5 cm/s
Backward feed rate:	10-12 cm/s
Hydraulic oil tank:	4 l (oil type - HLP 46)
Table adjustment:	570 / 770 / 1,060 mm
Max. diameter of split wood:	App. 400 mm
max. hydraulic pressure:	210 bar
Splitting pillar:	100 mm x 100 mm
Table dimensions:	App. 400 x 280 mm
Weight:	96 kg
Order No.	02020

Disposal

The disposal instructions are based on icons placed on the appliance or its package. The description of their meaning can be found in the "Marking on the appliance" chapter.

Operating staff requirements

The operating staff must carefully read the Operating Instructions before using the appliance.

Qualification

Apart from the detailed instruction by a professional no special qualification is necessary for using the appliance.

Minimum age

Only persons over 18 years of age can work with the appliance. An exception includes youngsters if they work within their professional education the purpose of which is to obtain knowledge supervised by a trainer.

Maintenance and treatment (pic. 2)

Always keep the wood splitter clean. Change hydraulic oil after 500 running hours. Use common hydraulic oil (HLP 46). Grease the splitting pillar with fat before each use - this will increase the life of slide jaws. Use only original spare parts when changing the constructional elements. Regularly check tightness and firmness at hydraulic hoses and hose couplings.

Attention:

- Fill in oil only when the splitter pillar is in an inserted position
- Regularly grease the splitting pillar and splitting knife with multipurpose fat (pic. 2/A)

Assembly of service arms, wheels, splitting cross and table (pic. 3 and 4)

Assembly of service arms - pic. 3

Feed the service arm (A) into the switching cradle (C) and screw with hexagonal bolt (D), bed (E) and check nut. Tighten the check nuts to such an extent that the service arm could be moved. Now connect the service arm (B) according to the described method on the right. Protective arches (F) on both service arms are always assembled using 2 bolts with cross groove (G).

TIP: Grease metal couplings with fat from above and below before that!

Assembly of wheels – pic. 4

Put the wheel axis with the foot lever (A) through both holes on the oil tank. Put the M6 socket-head screw (B) through the wheel axis and screw it with the check nut on the plate (C). Then install the turning wheel on both sides and secure it with a safety pin (D) on both sides. Slightly bend the safety pin to prevent falling out.

Table assembly - pic. 1

Depending on the split wood length, the table board can be fixed in three heights - 570 mm, 770 mm and 1,060 mm. Table locking levers (pic. 1/7) are fixed in every assembly position. Insert the table board to the required holders (pic. 1/12). Now secure the table board by the locking lever on both sides.

Lift adjusting (pic. 5)

The working output can be increased for wood pieces smaller than app. 50 cm and for more wood pieces by shortening the backward movement of the splitting knife.

Proceed as follows:

Put a short piece of wood on the splitter table and move the splitting knife as low as app. 2 cm above the wood. Switch the splitter off (red button on the switch and disconnect the plug). Now you can shorten the backward movement using the fixed rod (pic. 5/B) by fixing the rod in the required height with the adjusting screw (pic. 5/A).

Area of application

The appliance can only be used for wood processing. The split material must have the following dimensions:

- Minimum diameter: 120 mm
Maximum diameter: 300 mm
- Wood splitting along fibre is only allowed.
- Risk of getting jammed at branchy wood when splitting.
- Jammed piece of wood is released by tipping on the wood.
- Cutting the split wood out prohibited!

Split wood length adjusting

Wood of various lengths can be split depending on the splitter type:

Electric/hydraulic connection (pic. 6 and 7)

Plugging

All splitters are fitted with undervoltage release in the switch in accordance with provisions of branch professional organisations "CE", etc. The release prevents automatic starting of the appliance in case supply is interrupted as a result of power failure, unintentional unplugging, defective fuse, etc. The appliance must unconditionally be switched on again by pressing the green switching button. Wilful holding or blocking of the switching button with no directly earthed conductor automatically leads to switch failure. In this case that can subsequently be identified the guarantee expires.

- The appliance meets EN 61000-3-11 requirements and is subject to special connection conditions. That means that use on optionally selected connection points is inadmissible.
- The appliance can lead to occasional voltage fluctuations under unfavourable power conditions.
- The appliance is only designated to be used for connection points not exceeding the maximum allowed impedance of $Z_{max} = 0,233 \Omega$.
- As a user, you must make sure your connection point on which you want to use the appliance meets the above-mentioned requirements – after agreement with your electricity supplier if necessary.

Hydraulic equipment

Tightness needs to be checked at hydraulic hoses and couplings after app. 4 running hours and tightening must be provided if necessary.

Only at 400V appliances: It is necessary to be particular about the running direction of the engine (see the arrow on the engine) as running in wrong running direction can

damage the oil pump. In such a case, all claims arising from the guarantee expire. If necessary, have the running direction changed by reversal of polarity of the plug by a professional electrician. See pic. 6! (three-phase current models only!)

Hydraulic oil/tank

Common hydraulic oil (e.g. HLP 46 or oil of different producer of identical viscosity) can be filled in all splitters. Oil change is not necessary.

Vent the tank before each operation by screwing the filling screw out and in (pic. 7/A).

Operation



Attention: Make sure wood is cut at right angle, if possible, and seated closely on the splitting table. Cross-cut or extremely branchy wood can slide or bend the service arms.



Always put wood on surfaces (tables) designated for this purpose (never on the frame). That could damage the splitter.

1. Start the engine by pressing the green switching button. **Attention: Be particular about the running direction of the engine at 400V models!**
2. Keep the feeder cable as short as possible at 230 V models and select as big cross section as possible.
3. **When the temperature is low, let the splitter run idle for app. 15 minutes so that oil warms up to corresponding temperature.**
4. Put the split material on the table and hold it using clamping plates on the lever.
5. Splitting starts by pressing both levers down (as soon as the splitting knife enters wood tip the lever slightly out while pressing it down. This will prevent holding sheets (arms) from bending).
6. Lift at least one lever after you have finished splitting – the splitter pillar will automatically go up.

It is strictly prohibited to operate the wood splitter in two persons with one holding wood and the other one pressing on the clamping plates. Blocking one lever (clamping plate) is prohibited, too.

Transport instructions

Transport

All wood splitters are fitted with big wheels. Grasp the handle on the splitting pillar with one hand and handle above the engine with the other hand and slightly tilt the splitter to you for transport purposes. The splitter can effortlessly be moved in this position.

To prevent hydraulic oil leakage, never transport the splitter laid down.
Always let the splitting knife go absolutely down for transport.

Residual risks and protective measures



Warning!!!

Taking out of operation, any change, blocking, disassembly, changeover or assembly of all parts on safety and protective equipment of the appliance is strictly prohibited and can have serious consequences, i.e. life threatening injuries if not observed.

The producer cannot be held liable for material damages or injuries caused as a result of such negligence. All guarantee claims towards the producer immediately expire at each of the above-mentioned negligence. The splitter can only be operated by one person. Remove wood remnants that could block or negatively influence the safety and service elements near the splitter and workplace during operation.

Mechanical residual risks

Threat	Description	Protective measure(s)	Residual risk
Jamming	Parts of body can get jammed or amputated when splitting as a result of hydraulic knife going down. There is a risk the split wood gets jammed. Please be aware that wood is strongly tight when being removed and fingers can get jammed in the splitting crack.	Always use the two-hand safety operation. Do not interfere in the splitting process. Two persons must never work with the appliance Get out any jammed piece of wood. Beware of falling wood – it can injure your legs.	Worn-out or damaged aid must immediately be replaced. Have an eye to bystanders! Always wear safety shoes when working.
Cutting	Parts of body can get jammed or amputated when splitting as a result of hydraulic knife going down.	Always use the two-hand safety operation. Do not interfere in the splitting process.	Worn-out or damaged aid must immediately be replaced.
Common accidents	Violent splitting can cause serious injuries when dry wood is processed. Pieces of wood created during splitting can fall down and injure especially legs of the working person. Splitting wedge extension can get in the table and thus cause appliance damage or serious injuries of persons.	Never interfere in the splitting process. Always keep a sufficient safety distance. Always operate the appliance carefully and cautiously. Always wear specified protective clothing and work carefully. Always wear protective glasses when working with the appliance. Always wear specified protective clothing and work carefully. Wear corresponding safety shoes to the specified protective clothing. Always disassemble the table before working with the splitting wedge extension (see page 12)	Worn-out or damaged aid must immediately be replaced. Always have an eye to bystanders.
Getting caught, winding up	Wide clothing, jewels and long hair can get caught by moving parts.	Always wear close-fitting clothing; do not wear jewels and protect your hair with a hairnet.	

Electrical residual risks

Threat	Description	Protective measure(s)	Residual risk
Direct electric contact	Faulty cable or plug can be a cause of electric shock.	Always have any faulty cables or plugs replaced by a specialist. Use the appliance with a safety switch against stray current (FI).	Check the feeder cable before each use
Indirect electric contact	Injury by conductive parts of exposed electrical or faulty construction parts	Always disconnect the plug at maintenance work. To be operated only with a safety switch against stray current (FI).	

Noise threat

Threat	Description	Protective measure(s)	Residual risk
Hearing damage	Long-term working with the appliance can damage hearing.	Always wear earphones.	

Neglect of ergonomic principles

Threat	Description	Protective measure(s)	Residual risk
Negligent use of personal protective aids	Appliance operation without corresponding protective aids can cause serious external and internal injuries.	Always wear specified protective clothing and work carefully.	
Inadequate local lighting	Insufficient lighting represents a high safety risk.	Always ensure sufficient lighting when working with the appliance.	

Other threats

Threat	Description	Protective measure(s)	Residual risk
Thrown-away items or spraying liquids	Mechanical particles can injure your eyes when splitting.	Always wear protective glasses when working with the appliance.	

Failures

Failure	Cause	Removing
Splitter with no output	<ul style="list-style-type: none"> - Wrong running direction (only at 400 V) - Too little hydraulic oil - Booster rod bent; no full pushing of the hydraulic lifter - Wood with too many knags and splitting knife gets jammed - Service arm bent 	<ul style="list-style-type: none"> - Have the running direction changed by a specialist - Fill in hydraulic oil - Adjust the rod mechanism; tighten appropriate nuts - Grease the splitting knife with fat - Put the service arm to the starting position
Green switching button keeps releasing after being pushed	<ul style="list-style-type: none"> - Directly earthed conductor is not connected - Faulty fuse, etc. (only at 400 V) - Running at 2 phases (at 400 V) 	<ul style="list-style-type: none"> - Have the cable or power checked by a specialist - Check the cable
Hydraulic pump is whistling; intermittent running of the splitting knife	<ul style="list-style-type: none"> - Too little hydraulic oil in the tank 	<ul style="list-style-type: none"> - Fill in hydraulic oil

No other works than those for which the appliance has been made and those described in the Operating Instructions can be executed with this appliance.

