

# LS6T-52 Log Splitter

## Operation Manual

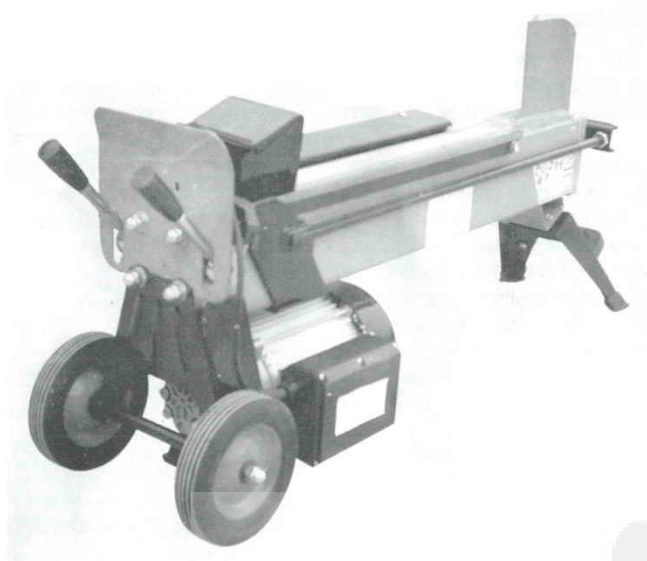

Please carefully read this operation manual before starting work.

CE

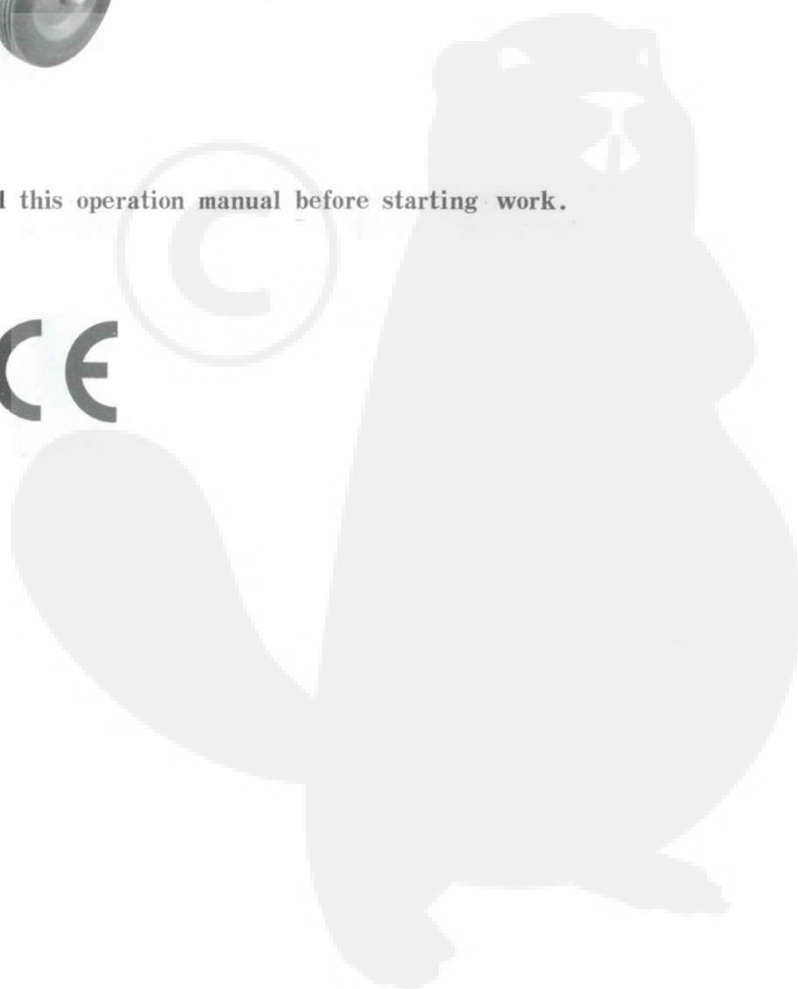
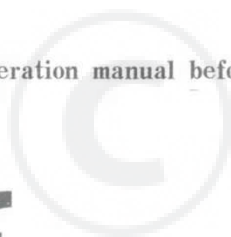

Thank you for purchasing Type LS6T-52 6-Ton Log Splitter. Please carefully read this operation manual and strictly observe these instructions for the safety of you and the personnel around you. In this manner, you will enjoy long and satisfactory use of this product.

### GENERAL SAFE RULES

#### Warning:

All the operation and use of the machine may have some risk but the carefulness and caution taken in use can remarkably reduce the risk of personal injury. The negligence of basic safety precautions can result in injury of operator or damage of property.

1. Read and fully understand the operation manual, including the operation and scope of application as well as potential hazards.
2. Check for damaged part. Before further use, should check protection device or damaged part to ensure the Log Splitter can have normal operation and finish intended duty. Check the function of motion parts and check whether the part or fixing device is broken or cracked, or other conditions that may have negative effect on the operating performance of the machine. Must repair and change protective device or damaged part as required.
3. Before starting maintenance work, switch off the power and do so even when changing the spare parts such as wedge, chisel or cutting bar.
4. Should keep the protective device in the state of readiness for work.
5. If required, should wear ear protector, eye protector/goggles, visor and work gloves.
6. Drugs, alcohols and medicine. Never operate this machine under the influence of alcohol or some medicines.
7. Never stand on the machine. Otherwise there will be risk of be injured when falling.
8. Never operate this machine without supervision. Switch off power supply.

Never leave off the machine until it completely stops.

9. When calibrating or changing the parts or working on the machine, should pull the power plug out of the outlet.
10. Make sure that the cord is fully protected and ensure no damage from assembly or material.
11. Should keep a safe distance between your hands and the log, and between the pusher and the wedge. If the splitter is turned on, never put the hand onto the motion parts of the machine.
12. Never wear ornaments or loose clothes, which can be entangled with the log chips.

### ELECTRICAL CONNECTION

Connect the power cord to a standard power supply via an approved plug or suitable protective and isolated switch. The power should meet specifications stated on the nameplate.

#### Extension cord

If the extension cord is applied, we recommend connecting a moisture-proof plug and keeping this plug away from moisture.

This cord will produce a voltage drop, which can hamper the electrical motor from giving a full power and reduce the machine's performance. Therefore, must let the cord satisfy the following specifications:

0 - 10 meters—Diameter of cord—2.5 square millimeters

**Never use extension cord exceeding 10 meters**

If in doubt, please inquire a qualified electrician. Never make electrical repair by yourself.

### Symbols used

Standard graphic symbols are used on all machines in order to ensure complete safety of all parts of the Log Splitter. As these symbols are very important, read the information below attentively.



It is obligatory to read the machine's use and maintenance manual in full before using the machine.



It is obligatory to wear safety footwear at all times to provide protection against the risk of logs accidentally falling on feet.



It is obligatory at all times to wear gloves which protect the hands against chips and splinters which may be produced during work.



It is obligatory at all times to wear goggles or a visor which protects the hands against chips and splinters which may be produced during work.



It is forbidden to remove or tamper with the protection devices and safety devices.



It is forbidden to stand in the range of action of the machine, apart from the operator, no other person or animal may be present within a radius of 5 meters from the machine.



Dumping of used oil in the environment is forbidden. The oil must be disposed of according to current legislation in the country where this operation is carried out.



Danger of cutting or crushing of the hand: never touch hazardous areas while the wedge is moving.



Warning: always pay attention to the movement of the log pusher.



Warning: never remove a log trapped in the wedge with your hands.



Warning: Before carrying out any maintenance operation described in this manual, disconnect the plug of the machine.



Warning: voltage as indicated on the rating plate

How to use control rod to vary the speed: when control rod at first position, i.e. position under the middle, the velocity of the Log Splitter is faster with smaller strength. when fully depressing the control rod, the Log Splitter's movement velocity is slower but can split the log with the biggest power.

### SPECIAL WARNINGS WHEN USING THE LOG SPLITTER

Using this powerful tool may create special hazards. Take particular care to safeguard yourself and those around you.

#### Hydraulic systems

Never operate this tool if there is a hazard presented by hydraulic system. Before using the splitter, check for hydraulic leaks. Be sure the tool and your work area are clean and free of oil spills. Hydraulic fluid can create hazards, causing you to slip and fall, your hands to slip while using the machine, or fire hazard.

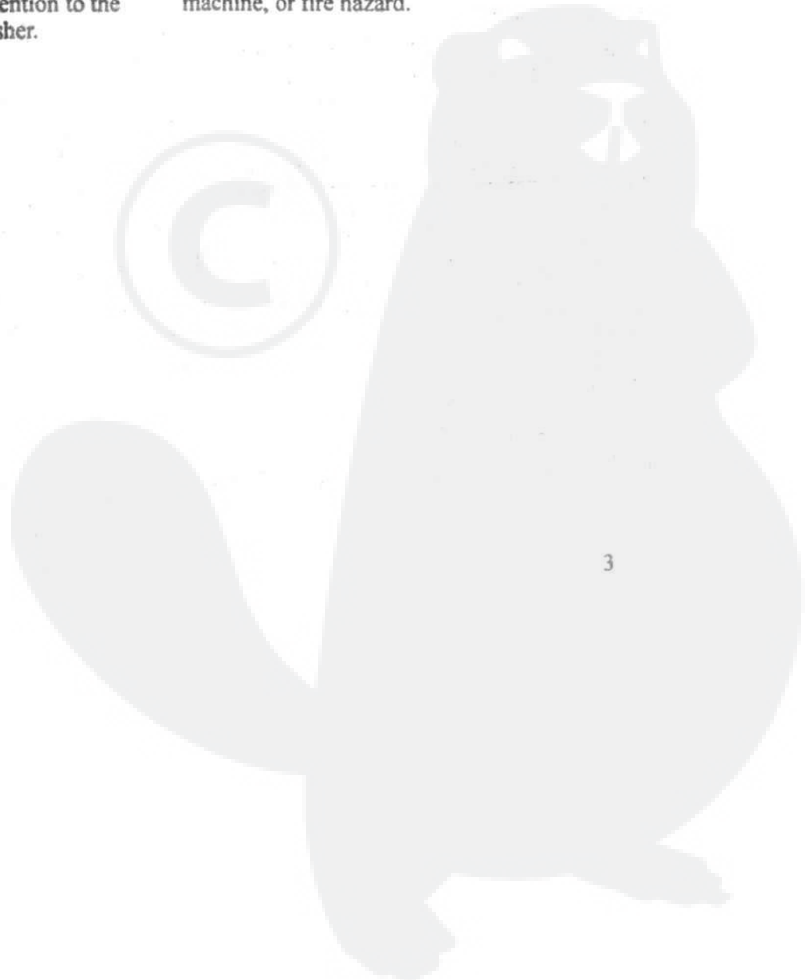
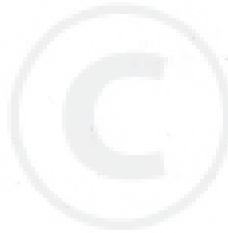

**Electrical Safety.**

Never operate this tool if there is an electrical hazard. Never operate an electrical tool in wet conditions. Never operate this tool with an improper electrical cord or extension cord. Never operate this tool unless you are plugged into a properly grounded outlet, which supplies specified power and is protected by a 16 Amp circuit breaker.

**Physical Hazards**

Log Splitting creates special physical hazards. Never operate this tool unless you are wearing proper safety gloves, hard-toed shoes and the approved eye protection. Be careful of the splinters that will be produced, to avoid puncture injury and potential jamming of the tool. Never try to split logs, which are too large or small to fit properly within the tool. Never attempt to split logs containing nails, wire or other debris. Clean up as you work: accumulated split wood and wood chips can create a hazardous work environment. Never continue to work in a cluttered work area, which may cause you to slip, trip or fall. Keep onlookers away from this tool, and never allow unauthorized persons to operate this tool.

**NOTICE:**

**No list of warnings is all-inclusive. The operator must supply common sense, and operate this tool in a safe manner**

**FEATURES OF THIS LOG SPLITTER**

- 1. Portable.** Small size, lightweight and built-in wheels make it easy to deliver this powerful tool to the work site.
- 2. Powerful.** 6-ton power delivered by a beefy 30cm hydraulic ram will make short work of your log splitting task.
- 3. Electric Powered.** Convenient and reliable electric powered hydraulic system avoids the expense and hassle of maintaining a small gas engine. Just plug it in and start splitting.
- 4. Hydraulic Ram.** Powerful hydraulic ram splits logs in a safe controlled manner, without axes, sledge hammers or wedge.
- 5. 2-Hand Safety Control.** Built-in safety design keeps your hands away from the log and splitter during operation.
- 6. Durable Steel Construction.** Welded steel construction, and enclosed hydraulic ram make this a tough, durable tool you'll use for years.

**MAIN SPECIFICATIONS**

		LS 6T-52
Electrical motor:	220 volts - 240 volts / 50 hertz	2850 rpm
	3 horsepower (2200 Watts)	
Max. force:	6 Tons	
Log size capacity:	520 mm (length)	(50 - 250) mm (diameter)
Ram Travel:	400 mm	
Ram Diameter:	30 mm	
Hydraulic Oil Capacity:	3.1 liters	
Overall dimensions:	970 mm (length) x 300 mm (Width) x 490 mm (height)	
Net Weight:	49 kgs	

**Special safety regulations for the Log Splitter****Warning:**

This powerful Log Splitter may cause special hazards. Pay special attention to protect yourself and those around you. Must observe basic safety precautions to reduce risk of injury. Please carefully read this operation manual before starting work.

1. This machine must be always be used by one operator only.
2. Never split the logs bigger than the specified log size capacity. The log is not permitted to have nails, which may jump up or damage the machine. The log end surface must be cut level and all the branches must be removed of the trunk. Should split the log along the direction of vein. Never put the log vertically onto the Log Splitter because this may damage the Log Splitter.
3. The operator must handle the control device with both hands and never use other means to operate the control device.
4. The Log Splitter must be operated by the adults who have read this operation manual only. Anybody not reading this manual is forbidden to use this Log Splitter.
5. Position the machine on a support of 60-75cm high, free from any objects that could prevent complete freedom of movement for the operator while working. Therefore we recommend using a special Log Splitter platform. Never operate the machine on the ground because this may arise the risk of the injury to the face due to the splinter or rubbish and make the operation difficult.
6. Never split 2 logs at one time otherwise

- the log may jump up. This is dangerous!
7. Never put or change log when machine in running because this is very dangerous.
  8. When the machine is running, the people or animal must be at least 5 meters away from the machine.
  9. Never tamper with the protective device of Log Splitter or work without the protective device.
  10. In order to split hard log, never force the Log Splitter for over 5 seconds. The superheated oil may damage the machine under pressure. In this case, should suspend the machine and turn the log by 90 degrees and then start splitting again. If the log can't be split yet, this means the log hardness exceeds the capacity of the machine and must pick out the log. In this way, the machine will not be damaged.
  11. Never leave the running machine unintended. If not working, should stop the machine and unplug the power.
  12. Never use this machine near the natural gas, gasoline tank or other flammable materials.
  13. Never open switch box or electrical motor cover. If need, contact the qualified electrician.
  14. Make sure that the machine and cord are kept away from the water. Take care to handle the cord. Never yank or tear the power cord. Keep the cord away from high temperature, oil and sharp objects.

#### Recommended log size

Log size capacity:  
 $520 \text{ mm (length)} \times (50 - 250) \text{ mm (diameter)}$

1. The specified diameter of the log is just for reference. If the fine log has knot or the log fiber is too hard, it would be very difficult to split.  
 If the fiber of a bigger log is smooth and loose, the splitter can also split it.
2. Never use the cam pressure to force the Log Splitter to split superhard log for over 5 seconds. The superheated oil can damage the machine under pressure.

It is important that if the log can't be split for the first time, then stop the machine and turn the log by 90 degrees and then start splitting. If the log can't be split yet, this means the log hardness exceeds the capacity of the machine and must pick out the log. In this way, the machine will not be damaged.

#### Recommended hydraulic oil

We recommend the use of the following hydraulic oil for the hydraulic ram:

**SHELL TELLUS T22**  
**ARAL VITAM G122**  
**SP ENGERGOL HCP22**  
**MOBIL DTE11**  
 Or equivalent oils

*Never use other kinds of oils.*

#### CHECK BEFORE UNCASING AND INSTALLATION

Take out all the components from the packing box and ensure each package is clear in the carton for the purpose of sorting and checking for the shipping damage. If finding any damaged component, should contact dealer immediately.

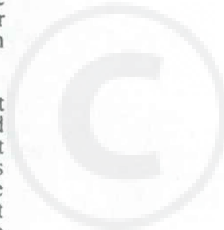

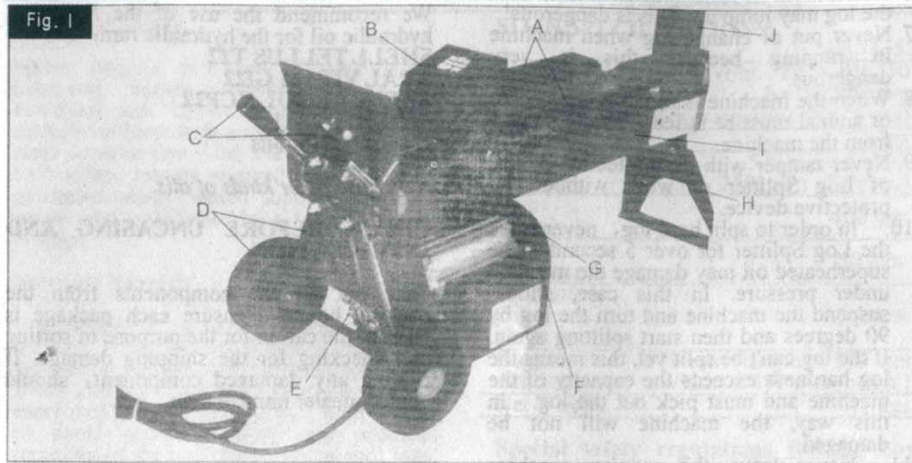

**Figure 1: List of major components**

Check these components according to the following list and Figure 1.

- A. Log guiding plates
- B. Log pusher
- C. Operating handle assembly
- D. Wheel and frame
- E. Oil pump
- F. Electrical motor switch
- G. Electrical motor assembly
- H. Supporting feet
- I. Main body
- J. Splitting wedge

All the screws, bolts, washer and jig are in the packing box. (The complete list is on the attached part list).

#### INSTALLATION OF WHEEL AND SUPPORTING FEET

Carefully take out the Log Splitter from the packing box with the help of another person and put it onto the foam material on the supporting surface (the foam material in the packing box together with the machine). (See Figure 2)

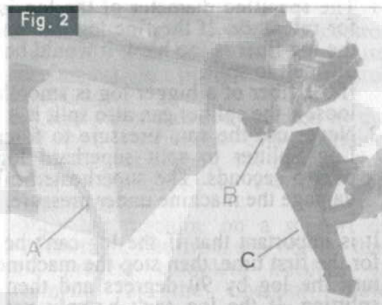

Put the main part on the foam material and fix with 2 screws (21) and 2 nuts (20) and tighten up the supporting feet (19). (See Figure 3)

On the main part that has been fixed on the foam block with the supporting feet, use safety ring (59) to fix 2 wheels (60) onto the shaft of wheel frame (61), then use the wheel shaft cover (58) to cover the wheels. Made sure that the wheels are not obstructed and turn uniformly. (See Figure 3)

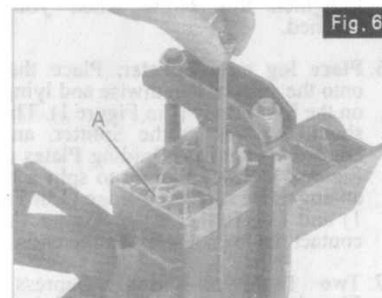
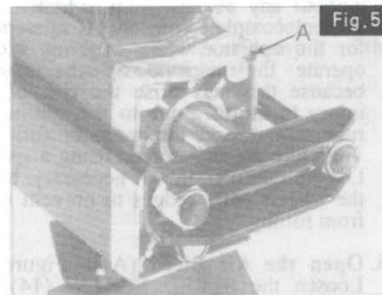
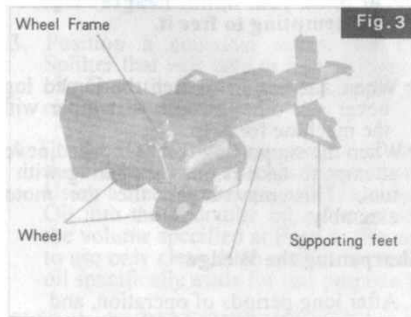

#### Installation of operating handle

Take out the operating handles(54/55) from the carton, and screw them onto the receiving hole(52)of the handles, then tighten up. (See Figure 4)

Now the Log Splitter is ready for work.

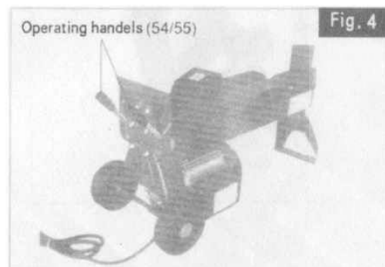

#### OPERATION

- 1 **Plan your work site.** Work safely and save effort by planning your work before hand. Have your logs positioned where they can be easily reached. Have a site located to stack the split wood or load it onto a nearby truck or other carrier.
- 2 **Prepare the logs for splitting.** This splitter accommodates logs up to 520mm in length. When cutting up limbs and large sections, do not cut sections any longer than the specified length. Do not attempt to split green logs. Dry, seasoned logs split much more easily, and will not jam as frequently as green wood (moisture).
- 3 **Route the power cord.** Locate an appropriate power outlet, and secure an adequate extension cord, if needed. Route the cord from the splitter to the power source in a way that safeguards against tripping on the cord, or the cord becoming damaged during the work session. Be sure to avoid wet conditions.
- 4 **Position Splitter Securely.** Be sure the splitter is positioned firmly on level,

solid supporting platform, 60-70cm high, without any objects on it, which could prevent complete freedom of movement for the operator while working. Never operate the machine on the ground because this may arise the risk of the injury to the face due to the splinter or rubbish and make the operation difficult. Therefore we recommend using a special Log Splitter platform. If necessary, block the wheels with wedges to prevent them from rolling.

5. **Open the Air Bleed** (A in Figure 5). Loosen the BLEED SCREW (14) 3-4 turns whenever the splitter is being used. Retighten this screw when you are finished.
  6. **Place log onto Splitter.** Place the log onto the splitter, lengthwise and lying flat on the Main Body (I in Figure 1). The log should lie flat on the Splitter, and be cradled by the Log Guiding Plates (A in Figure 1). Never attempt to split a log at an angle. Be sure the Wedge (J in Figure 1) and Log Pusher (B in Figure 1) will contact the log squarely on the ends.
  7. **Two hand operation.** Depress the Electric Motor Start Switch (Point F in Figure 1) with one hand. Wait a few seconds as the motor spins up and creates pressure in the Hydraulic pump. Then, when it is safe to do so, depress the Operating Handle (C in Figure 1). The Log Pusher (B in Figure 1) will compress the log, pushing it against the Wedge (J in Figure 1), splitting the log. Once the log is split, release both the Electric Motor Start Switch (F in Figure 1) and the Operating Handle (C in Figure 1); this will allow the Log Pusher (B in Figure 1) to retract.
- Warning: If the log does not split immediately, do not force it by maintaining the thrust for more than a few seconds. This can damage the tool. It is better to try repositioning the log on the splitter, or setting the log aside.**
8. **Stack as you work.** This will provide a safer work area, by keeping it uncluttered, and avoid the danger of tripping, or damaging the power cord.
  9. **Remember** to retighten the BLEED SCREW (Pos. 14 in Figure 5) when you are finished.

## HOW TO FREE A JAMMED LOG

1. Release both controls, so that the LOG PUSHER (Pos.B in Figure 1) will be fully retracted.
2. Insert a triangular wedge of wood under the log, and activate the log pusher to push the wedge under the jammed log.
3. Repeat this process using progressively larger wedges, until the jammed log is freed.

**Warning: Never hammer on the jammed log, or place your hands near the log when attempting to free it.**

- When attempting to free the jamed log, never ask other people to tamper with the machine for help.
- When the supporting feet is blocked, never attempt to take it out by striking with a tool. This may break the the motor assembly.

## Sharpening the Wedge

1. After long periods of operation, and when required; sharpen the wedge using a fine-toothed file and carefully removing any burrs or flat spots on the edge.

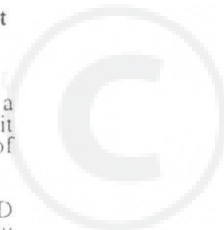



**Warning!**

Be sure to unplug the power before any maintenance work!

**Changing the Hydraulic Oil**

(The quantity of the hydraulic oil and recommended type have been indicated on page 5).

1. Make sure the LOG PUSHER (B in Figure 1) is fully retracted.
2. Unscrew the DIP STICK (10) and remove it together with O-type oil seal (11). (Figure 6)
3. Position a container under the Log Splitter that will hold at least 4 liters of oil. Then tilt the machine to empty the oil into the container.
4. Tilt the Log Splitter the other way, with the Oil Fill/Drain Port (in Figure 7) up. Using a clean funnel, pour the Hydraulic Oil into the hydraulic oil cylinder with the volume specified at Page 4. (Be sure to use only clean, high quality hydraulic oil specifically made for this purpose.)
5. Clean the DIP STICK (10), and insert it to make sure the oil level is between the two marks on the dipstick.

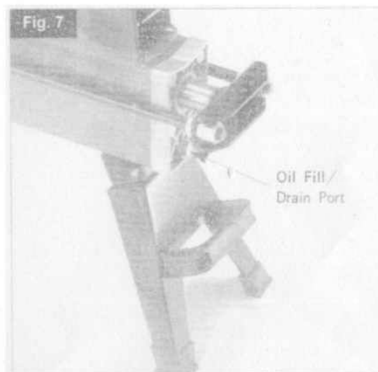

6. Clean the DIPSTICK (10) and O-Type SEAL (11) and re-install. Be careful not to damage the threads of the aluminum OIL CYLINDER COVER.

**Warning!**

Be sure to dispose of the dirty oil properly. Take it to your local waste oil-recycling center. Never dump it on the ground or mix it with trash.



**Trouble-shooting**

Problems that may arise when using the log splitter and recommended remedies are given in the table below. In the case of operations carried out by unauthorized personnel, the guarantee will be immediately null and void and the manufacturer will be relieved of any responsibility for injury to persons and animals and damage.

Problem	Probable cause	Corrective action
Log fails to split	Incorrect positioning of the log	Position correctly the log
	Log exceeds permitted dimensions or the wood is too hard for the capacity of the machine.	Try to cut a small part or use other means to reduce the size of the log
	Wedge do not cut	Sharpen the wedge, check for burrs or nicks, file if necessary
	Oil leak	Locate the leak using a piece of card or wood.
	Hydraulic pressure too low	Contact your dealer
Log Pusher/Cam advances jerkily or with strong upward vibrations	Air in the circuit	Check oil level. Fill oil if necessary. If problem remain, contact your dealer.
Oil leak from the Cams or from other external points	Leakage from the tank	Check that the bleed screw has been unscrewed before using the machine.
	Seals worn	Contact your dealer

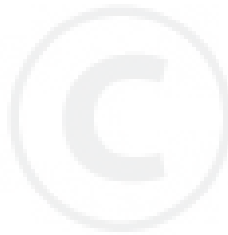

Parts Diagram

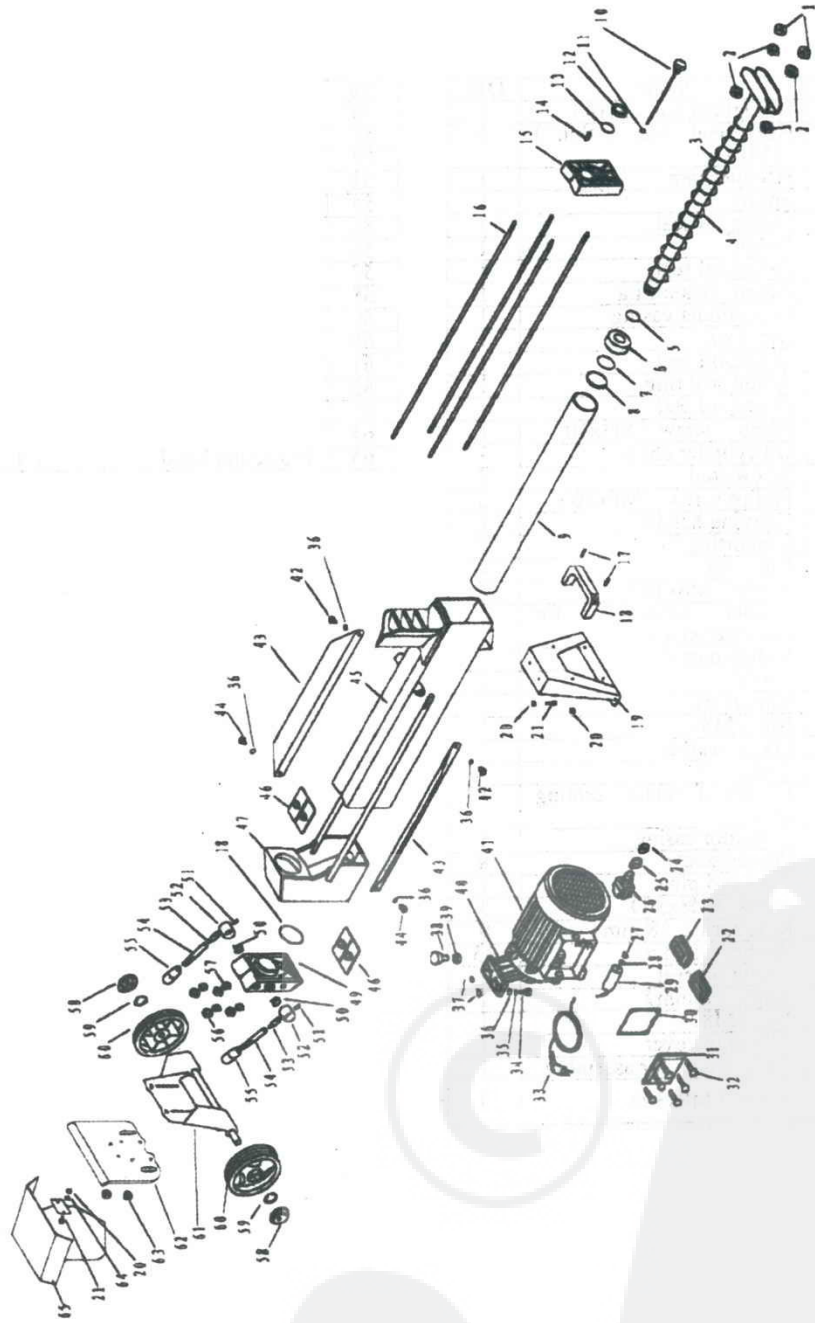

## Log Splitter Parts List

No	Name	Qty
1	Hexagonal nut (M14)	2
2	Hexagonal nut ( thin ) (M14)	4
3	Hammer ram	1
4	Spring	1
5	O-ring oil seal	1
6	Piston	1
7	O-ring oil seal	1
8	Square piston ring	1
9	Oil cylinder casing	1
10	Dip stick	1
11	O-ring oil seal	1
12	Teflon seal ring	1
13	O-ring oil seal	1
14	Bleed screw (M3x10)	1
15	Oil cylinder cover	1
16	Screw stud	2
17	Philips screw (M6x20)	2
18	Carrying handle	1
19	Supporting foot	1
20	Nut (M6)	4
21	Screw (M6x14)	2
22/23	Rubber supporter for electrical motor	1
24	Switch dust shield	1
25	Switch	1
26	Switch seat	1
27	Nut (M8)	1
28	Fixing washer	1
29	Capacitor	1
30	Dustproof rubber sealing ring	1
31	Capacitor casing	1
32	Philips screw	8
33	Cord and plug	1
34	Screw (M8x30)	3
35	Ring spring (8 mm)	9
36	Washer (8 mm)	13
37	O-ring oil seal	2
38	Screw (8 mm)	1
39	Nut (M8)	1
40	Oil pump cover	1
41	Electrical motor assembly	1
42/44	Screw (M8x30)	4
43	Log guiding plate	2
45	Main body	1
46	Plastic sheath plate	2
47	Log pusher assembly	1
48	O-ring oil seal	1
49	Oil cylinder cover - front	1

No	Name	Qty
50	Spring	1
51	Fixing screw (M8x30)	1
52	Handle seat	1
53	Valve knob	1
54	Handle bar	1
55	Handle	1
56	Nut (M8)	2
57	Brass shim	4
58	Wheel axle cover	2
59	Shaft fixation hook	2
60	Rubber wheel	2
61	Wheel frame	1
62	Support plate	1
63	Washer (10 mm)	2
64	Spring	1
65	Protection hood	1

**PLEASE READ THE FOLLOWING CAREFULLY**

THE MANUFACTURER AND/OR DISTRIBUTOR HAS PROVIDED THE PARTS DIAGRAM IN THIS MANUAL AS A REFERENCE TOOL ONLY. NEITHER THE MANUFACTURER NOR DISTRIBUTOR MAKES ANY REPRESENTATION OR WARRANTY OF ANY KIND TO THE BUYER THAT HE OR SHE IS QUALIFIED TO MAKE ANY REPAIRS TO THE PRODUCT OR THAT HE OR SHE IS QUALIFIED TO REPLACE ANY PARTS OF THE PRODUCT. IN FACT, THE MANUFACTURER AND/OR DISTRIBUTOR EXPRESSLY STATES THAT ALL REPAIRS AND PARTS REPLACEMENTS SHOULD BE UNDERTAKEN BY CERTIFIED AND LICENSED TECHNICIANS AND NOT BY THE BUYER. THE BUYER ASSUMES ALL RISK AND LIABILITY ARISING OUT OF HIS OR HER REPAIRS TO THE ORIGINAL PRODUCT OR REPLACEMENT PARTS THERETO, OR ARISING OUT OF HIS OR HER INSTALLATION OF REPLACEMENT PARTS THERETO.

