

MANUEL D'UTILISATION

SERRE 2250x2250x2500

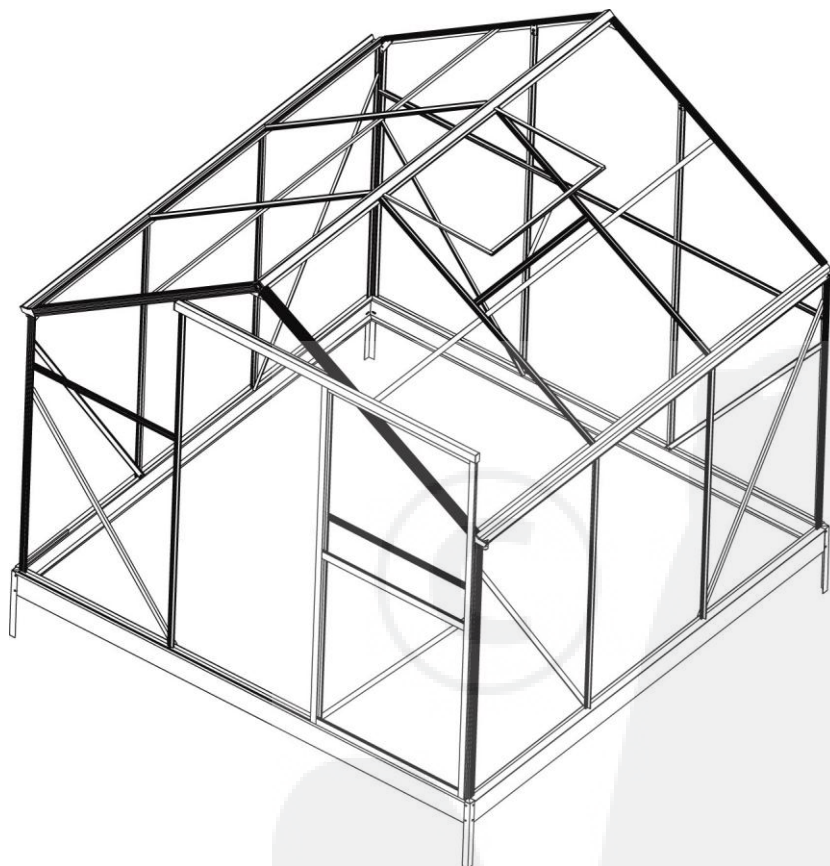

Ref : XLSERRE

Important

Lire attentivement cette notice avant de commencer le montage.
Vérifier la présence de toutes les pièces mentionnées dans cette notice.
Respecter l'ordre de montage.

























































Instructions de sécurité

- Porter les équipements de protection nécessaire (gants, chaussures et lunettes de protection) pour le montage.
- Ne pas monter la serre en cas de pluie, orage ou vent.
- Respecter les consignes de sécurité des outils nécessaires au montage.
- Ecarter toute personne étrangère au montage du chantier.
- Ne pas mettre les sachets plastiques et les petits composants a la portée des enfants.
- Ne pas mettre les profilés aluminium en contact avec une source électrique.
- Ne pas stocker d'appareil produisant de la chaleur dans la serre (barbecue, chauffage etc.)
- Positionner et fixer la serre sur une surface plate et non exposée au vent.
- S'assurer de l'absence de réseaux (eaux, gaz, électricité) sous l'emplacement de la serre.
- Ne pas monter sur le toit: risque de chute et de blessures.

Conseils

- Choisir un emplacement ensoleillé.
- Si vous désirez fixer la serre sur un sol béton, utiliser les trous pré-perforés de la base métal (cf. étape 16). Ces vis ne sont pas fournies.
- Le sens d'ouverture de la porte est à droite et ne peut pas être modifié.

Éléments du kit

 D1 x2	 7 x4	 17 x1	 S1 x2	PANNEAU EN POLY-CARBONATE	
 D2 x2	 15 x4	 13 x1	 S2 x4		P1 x2
 D3 x1	 8 x2	 21 x4	 S3 x1		P2 x1
 D4 x2	 9 x2	 22 x2	 S4 x6		P3 x4
 W1 x1	 10R x1	 23 x2	 S5 x2		P4R x2
 W2 x2	 10L x1	 B1 x1	 S6R x2		P4L x2
 W3 x1	 18 x4	 B2 x16	 S6L x2		P5 x1
 W4 x1	 19 x4	 B3 x6	 S7 x2		P6 x1
 1 x2	 11 x4	 B4 x4	 S8 x1		P7 x1
 2 x2	 14 x1	 B5 x4	 F1 x6		P8 x6
 3 x4	 20 x1	 B6 x2	 F2 x4	P9 x5	
 4 x2	 12 x1	 B7 x1	 F3 x8	P10 x1	
 5 x1	 16 x1	 B8 x1	 F4 x130	OUTILS FOURNIS	
 6 x1			 F5 x1		 x1
			 F6 x2	 x1	

Outillage et équipement préconisé

Tournevis	Mètre
Mastic et Silicone	Maillet
Niveau	Ciseaux
Escabot	Gant de protection
Poinçon	Perceuse et foret 2mm

Vue générale des panneaux en polycarbonate

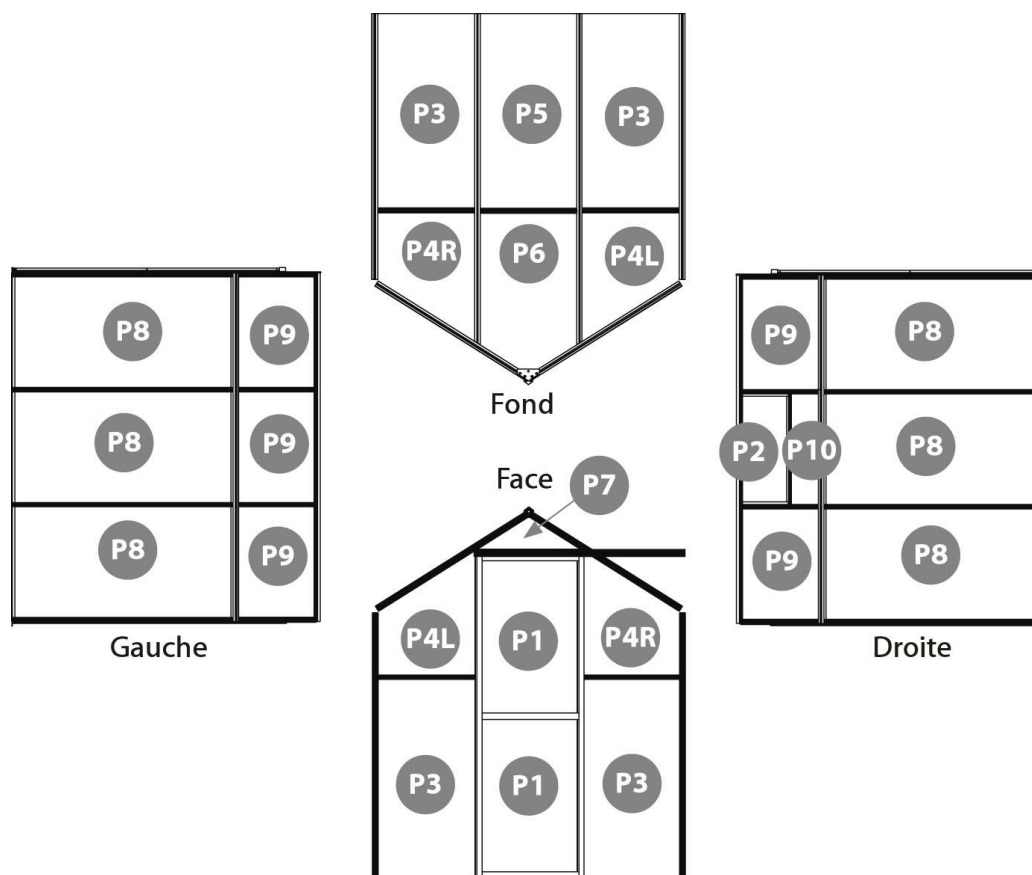

Le côté des panneaux polycarbonate recouvert d'un film plastique correspond au côté protégé des UV. Il doit être mis côté extérieur de la serre.

Vis à tête hexagonal

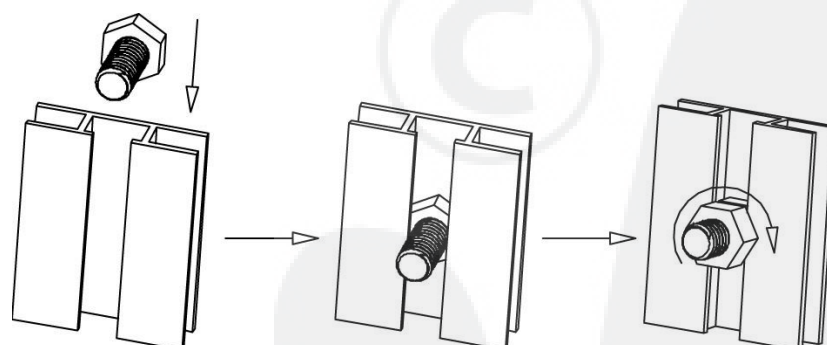







Insérer la vis dans la glissière du profilé, puis serrer l'écrou jusqu'à ce qu'il ne tourne plus.

PORTE

Etape 1 :

Eléments nécessaires : **D1x2** **D2x2** **D3x1** **D4x2**
S1x2 **F1x6** **P1x2**

PART	NO.	Qty.
	D1	2
	D2	2
	D3	1
	D4	2
	S1	2
	F1	6

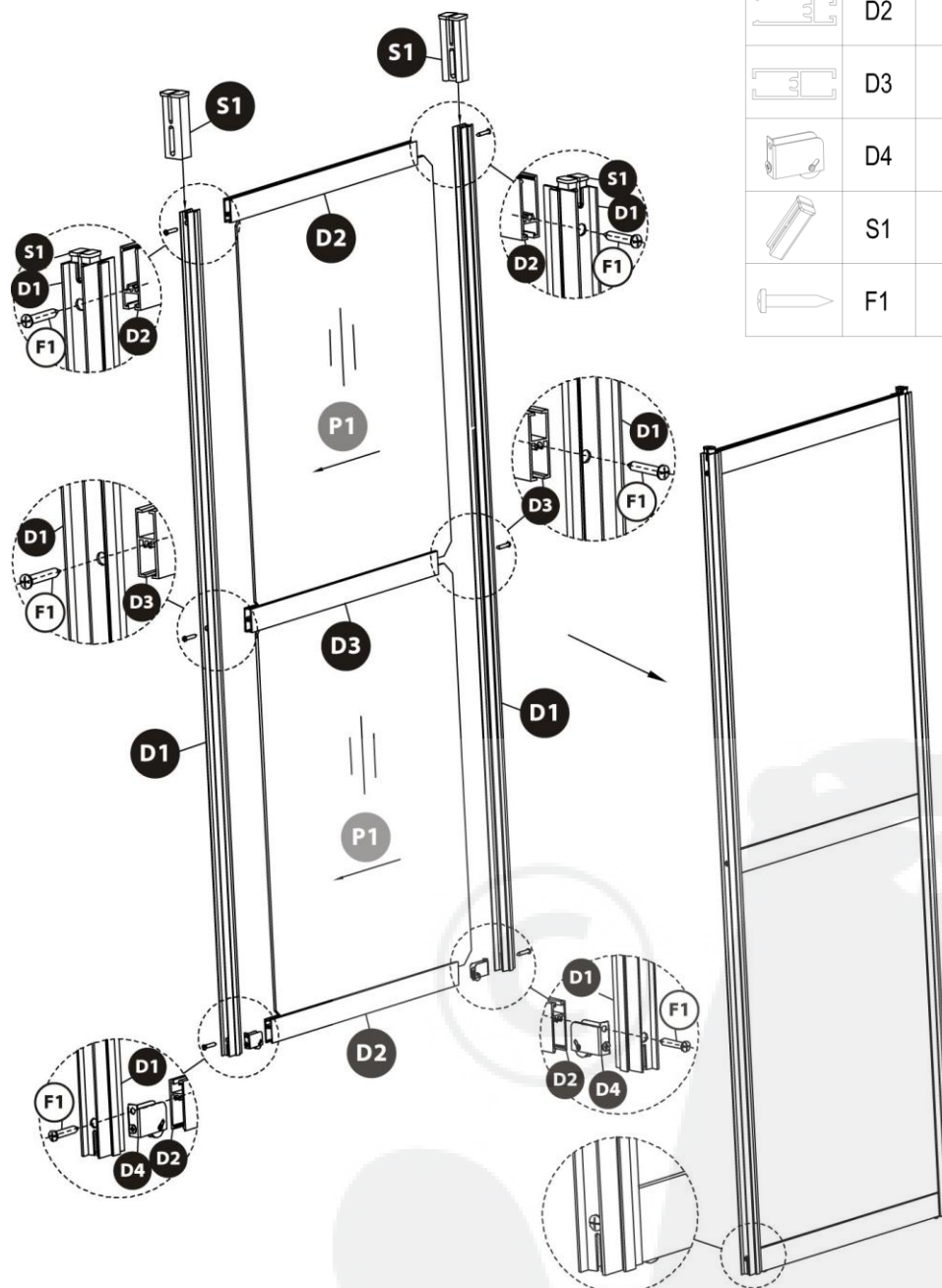

Nota

- **D4** est déjà assemblé avec **D2** par l'usine.
- Encastrer **P1** dans **D2** et **D3**.
- Ensuite encastrer **S1** dans **D1**.
- Puis assembler l'ensemble à l'aide de 6 vis **F1**.

FENÊTRE

Etape 2 :

Eléments nécessaires : **W1**x1 **W2**x2 **W3**x1 **W4**x1
S8x1 **F2**x4 **F5**x1 **P2**x1

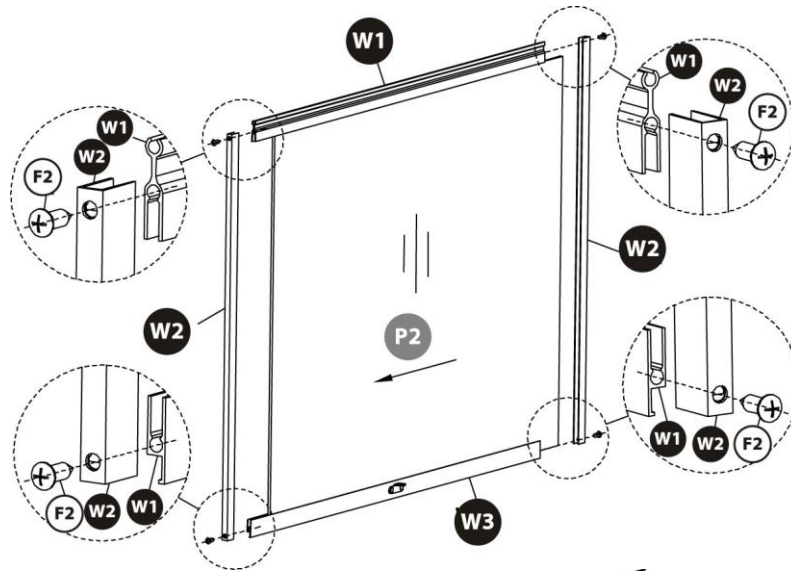

PART	NO.	Qty.
	W1	1
	W2	2
	W3	1
	W4	1
	S8	1
	F2	4
	F5	1

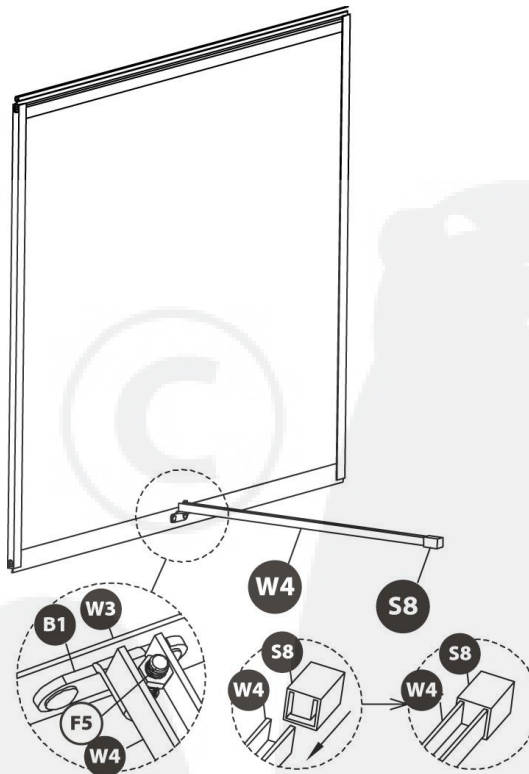





Nota

- **B1** est déjà assemblé avec **W3** par l'usine.
- Encastrer **P2** dans **W1** et **W2**.
- Ensuite assembler les deux côtés **W2** à l'aide de 4 vis **F2**.

STRUCTURE

Etape 3 :

Eléments nécessaires : **4**x2 **5**x1 **6**x1 **7**x4 **10R**x1 **10L**x1 **F4**x18

PART	NO.	Qty.
	4	2
	5	1
	6	1
	7	4
	10R	1
	10L	1
	F4	18

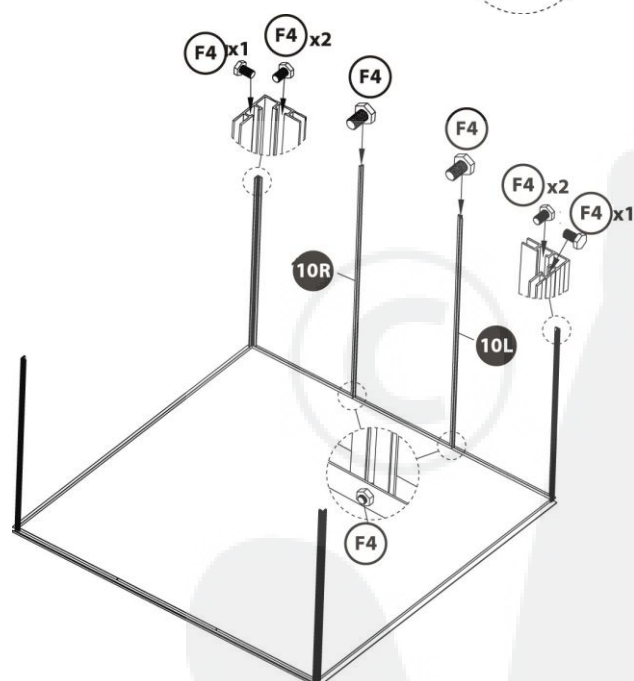
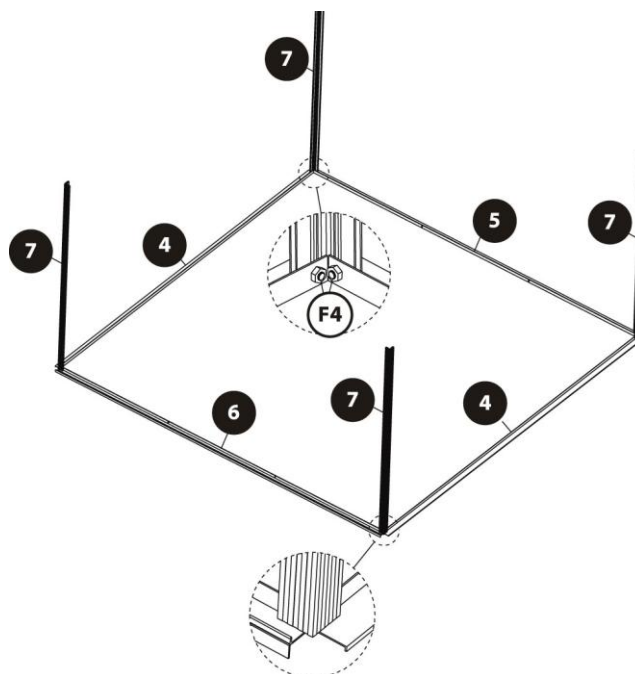

Nota

- Assembler le montant **10R** sur le support **5** avec une vis **F4** sans oublier de placer une vis dans **10R**. Répéter l'opération pour **10L**.
- Placer trois vis **F4** dans les deux montants **7** fixés sur le support **5**.

Etape 4

Eléments nécessaires : S2x2 S3x1 11x2 13x1 14x1 F4x6
 P3x2 P4Lx1 P4Rx1 P5x1 P6x1

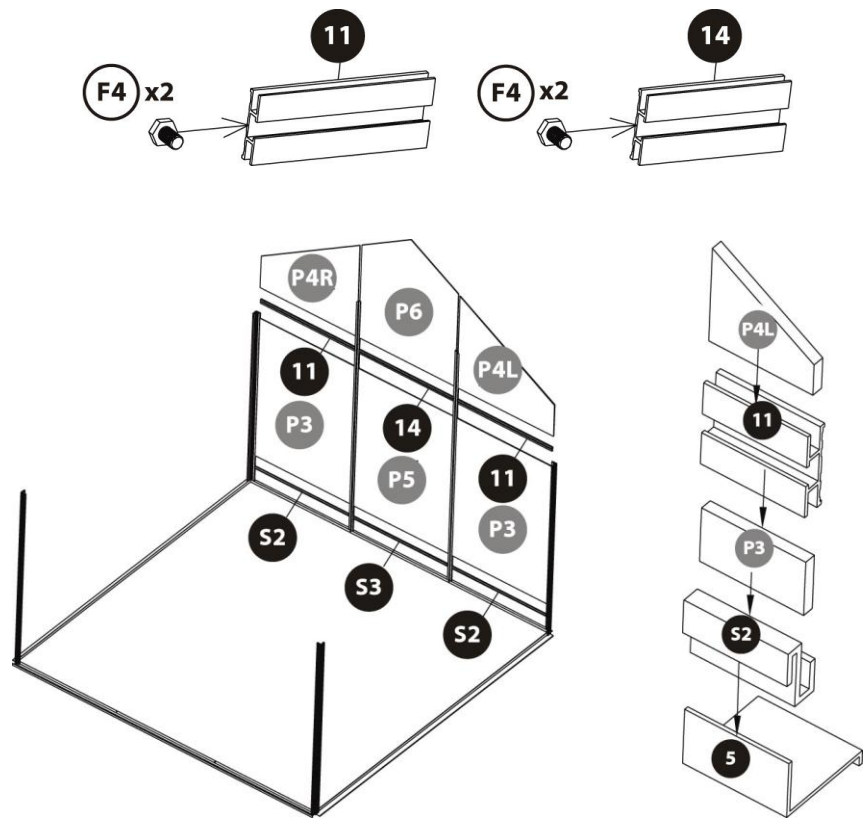

PART	NO.	Qty.
	S2	2
	S3	1
	11	2
	14	1
	13	1
	F4	6

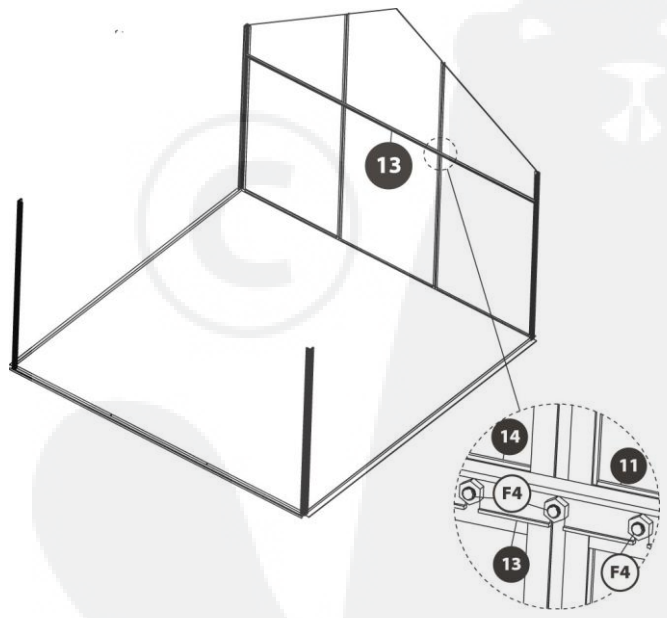



Nota

- Repère **13** correspond à la barre entière.

Etape 5

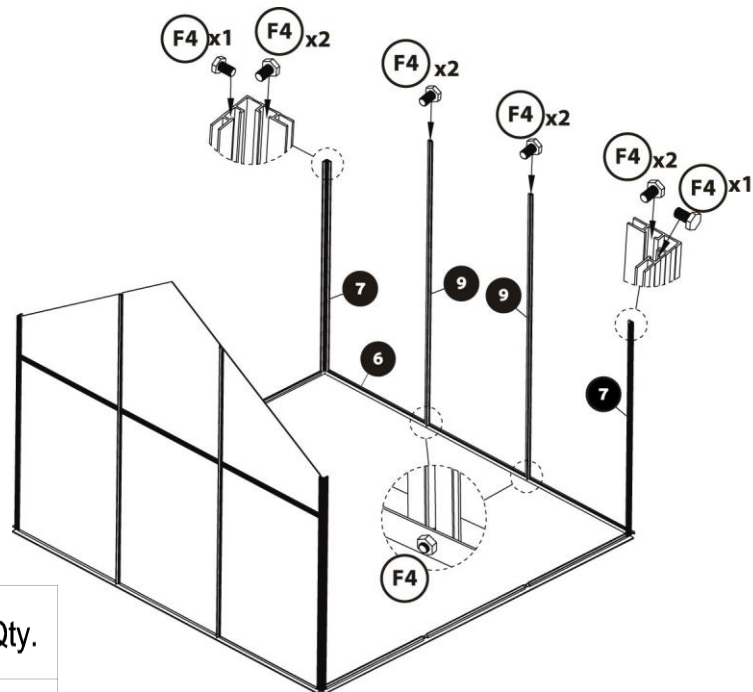
Eléments nécessaires : 9x2 12x1 F4x12

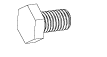

PART	NO.	Qty.
	9	2
	12	1
	F4	14

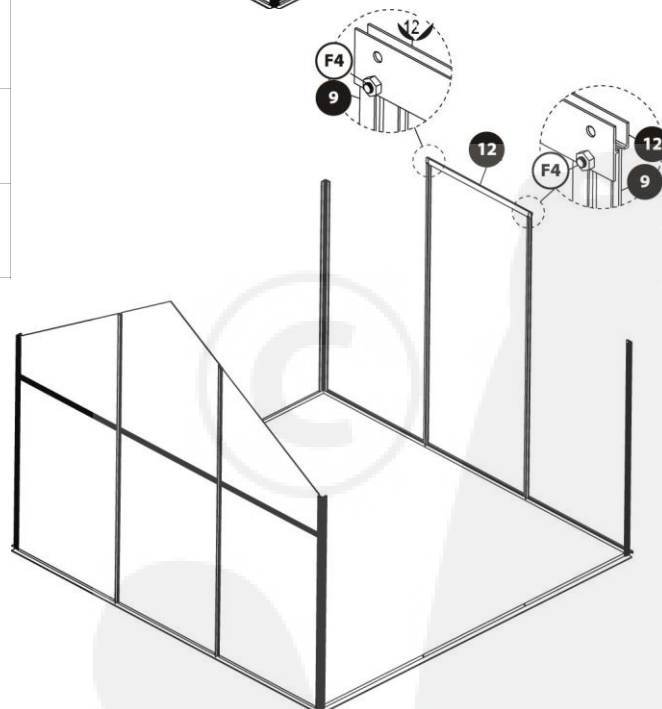





Nota

- Assembler le montant 9 sur le support 6 avec une vis F4 et placer deux autres vis. Répéter l'opération pour le deuxième élément 9.
- Placer trois vis F4 dans les deux montants 7 fixés sur le support 6.

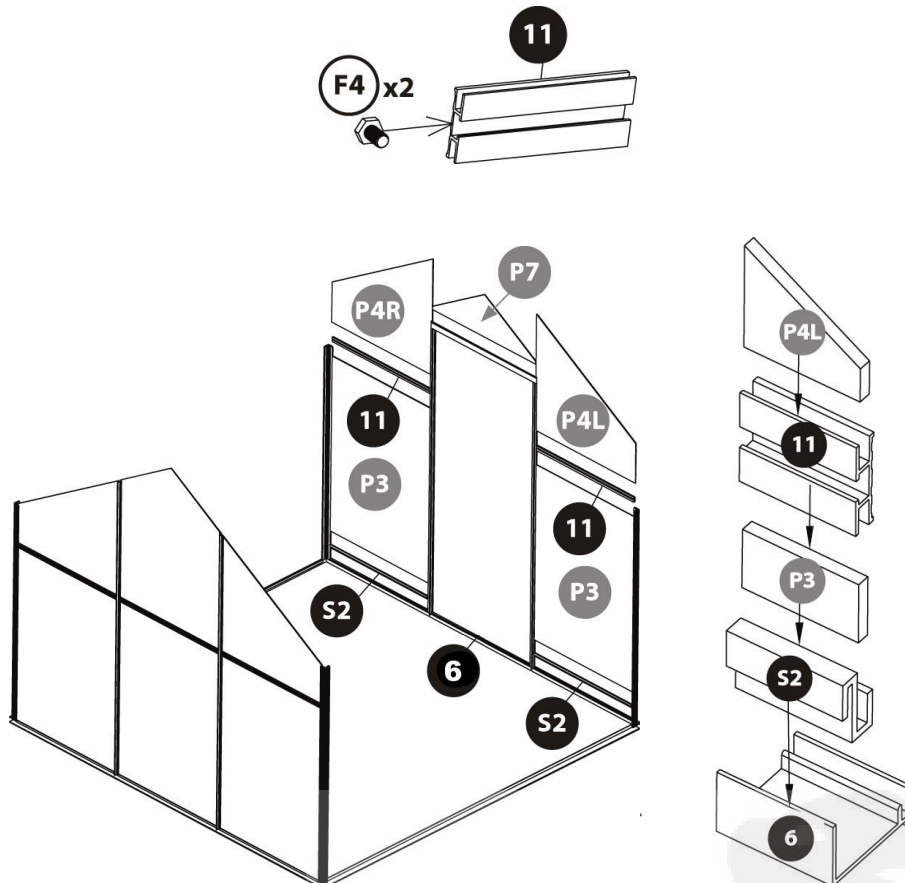
Etape 6

Eléments nécessaires : S2x2 11x2 B3x4 F4x4
P3x2 P4Lx1 P4Rx1 P7x1



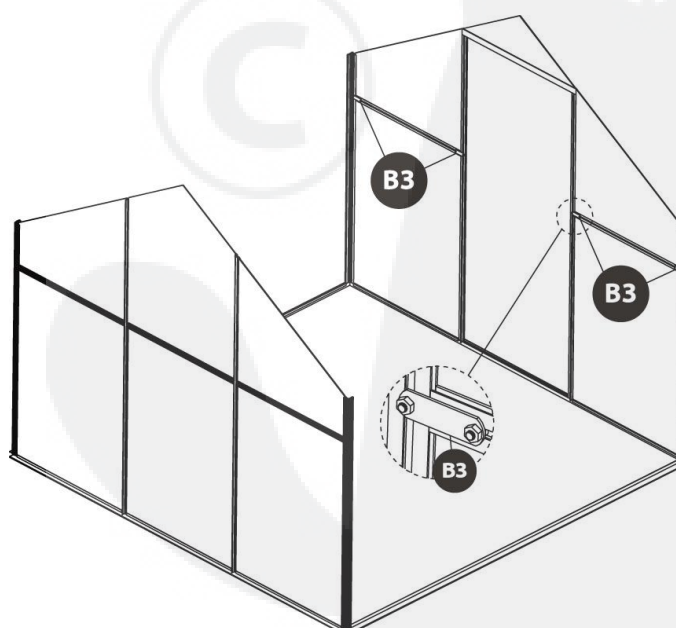

PART	NO.	Qty.
	S2	2
	11	2
	B3	4
	F4	4



Etape 7

Eléments nécessaires : 8x2 15x4 F4x12

PART	NO.	Qty.
	8	2
	15	4
	F4	38

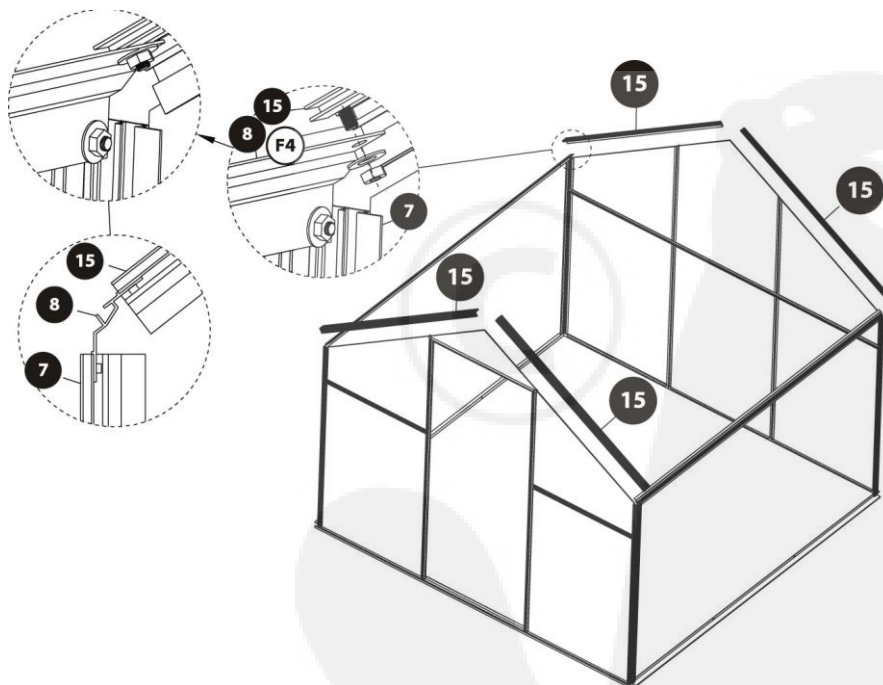
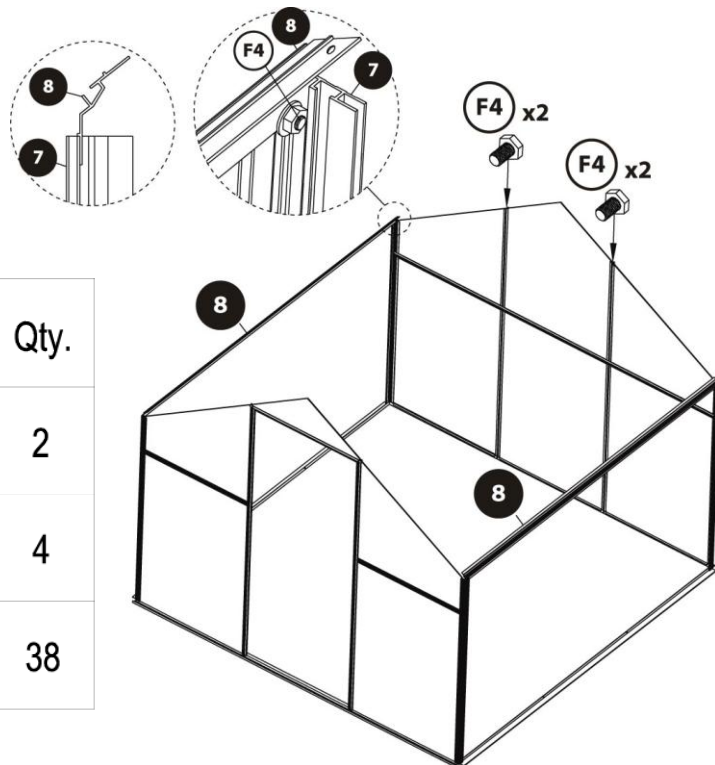





Nota

- Veiller à bien respecter le sens de montage du profilé 8 pour l'assemblage de la gouttière. (voir étape 13)

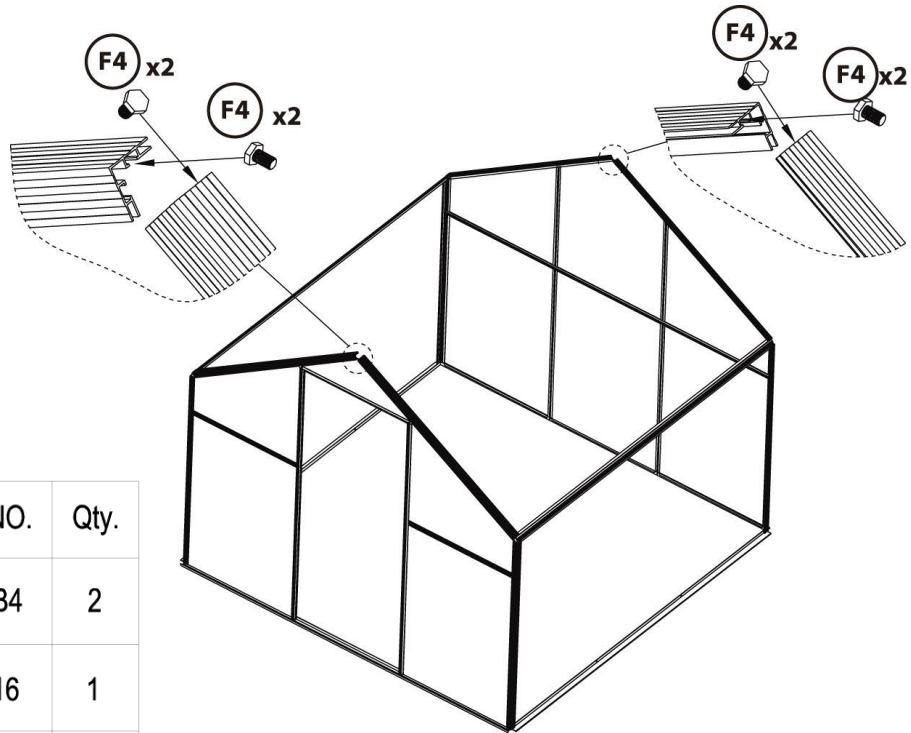
Etape 8

Eléments nécessaires : **16**x1 **B4**x2 **F4**x12 **F6**x2





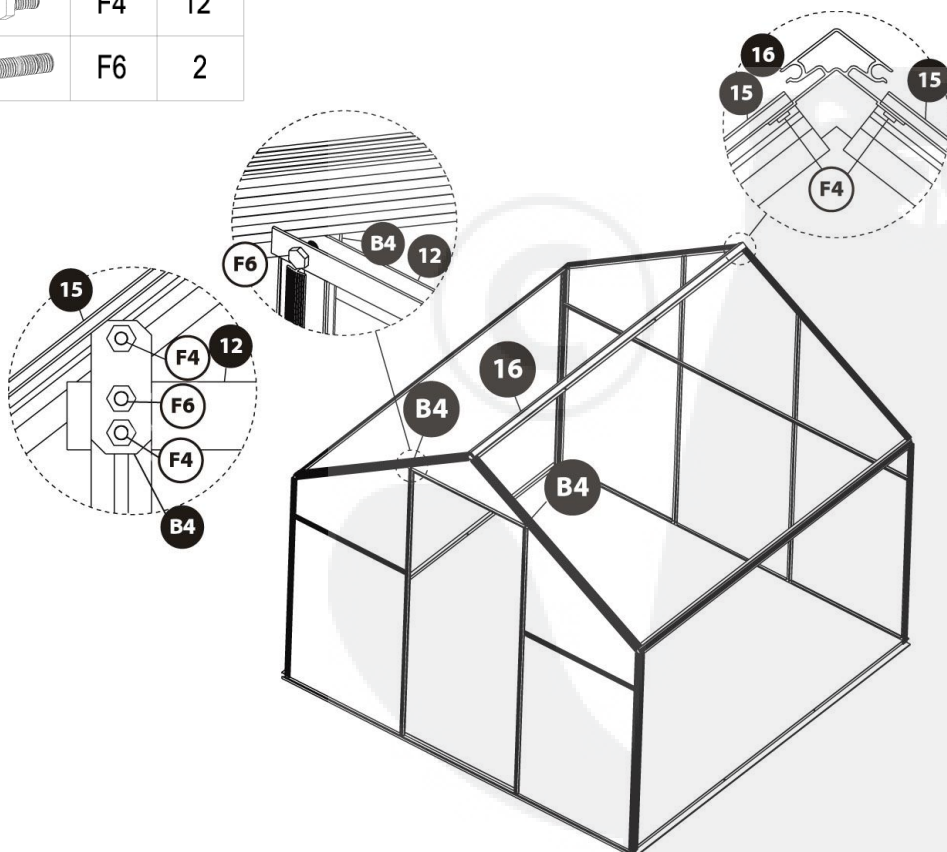

PART	NO.	Qty.
	B4	2
	16	1
	F4	12
	F6	2



Etape 9

Eléments nécessaires : 17x1 B4x2 B5x4 B6x2
F4x28

PART	NO.	Qty.
	B4	2
	B5	4
	B6	2
	17	1
	F4	38

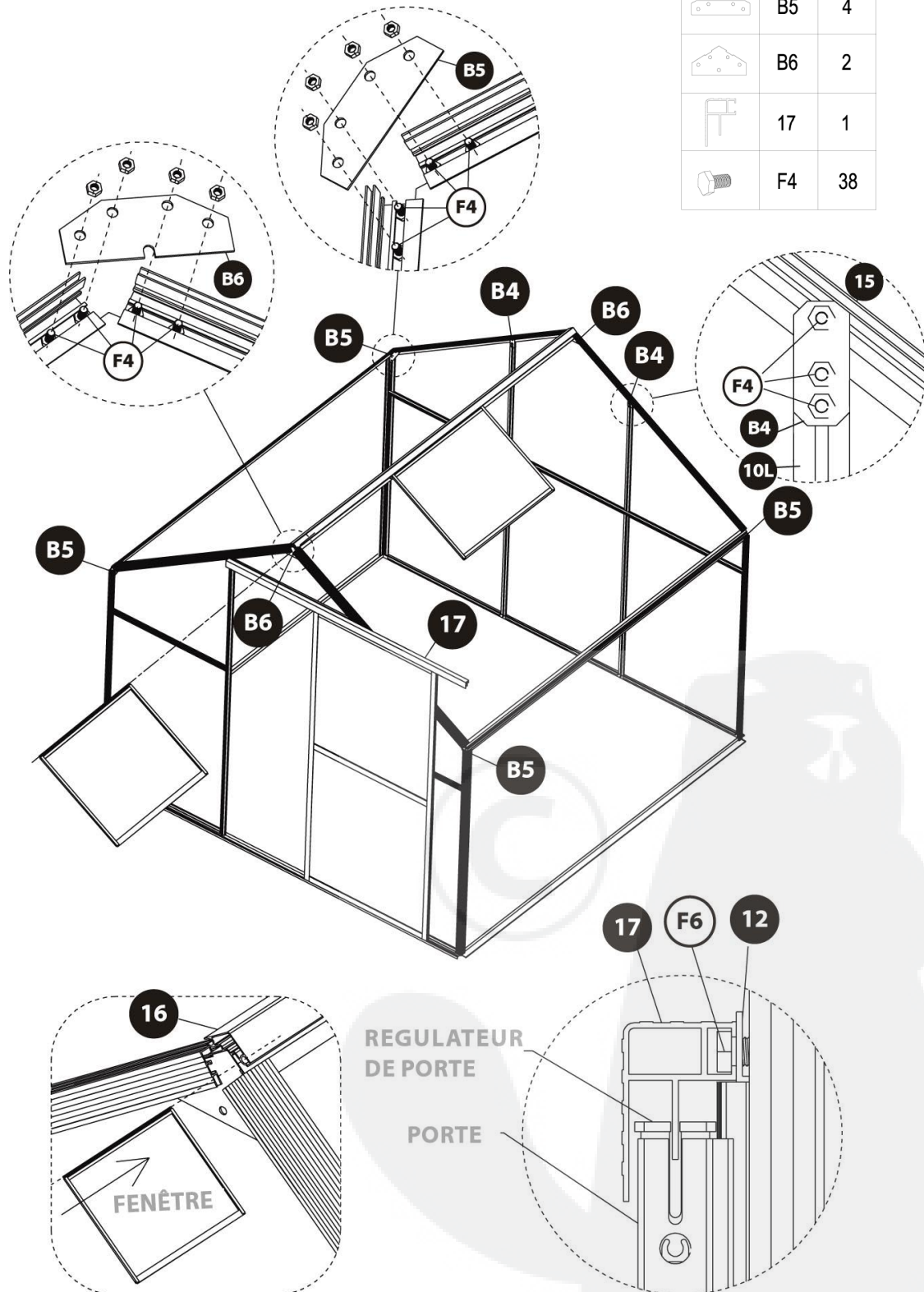

Etape 10

Eléments nécessaires : 18x4 19x4 F4x22

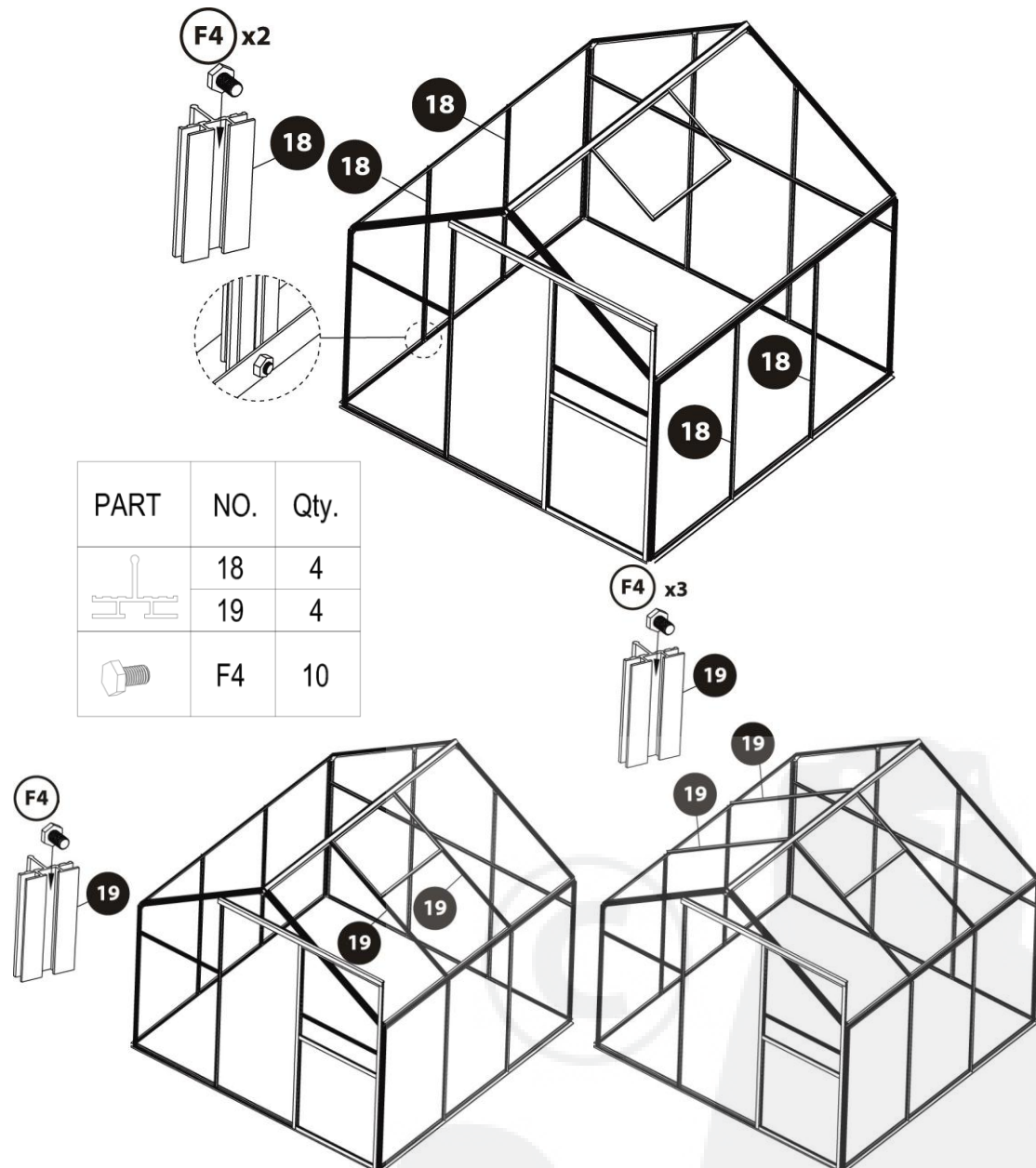





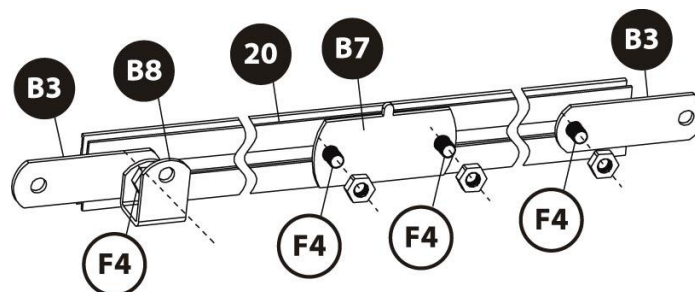

Nota

- Placer 4 vis F4 dans les profilés 19 du milieu, côté fenêtre. Ne placer que 3 vis F4 dans les autres profilés 19.

Etape II

Eléments nécessaires : **20**x1 **21**x4 **22**x2 **24**x4
B3x2 **B7**x1 **B8**x1 **F4**x4



PART	NO.	Qty.
	20	1
	B7	1
	B3	2
	B8	1
	21	4
	22	2
	24	4
	F4	4

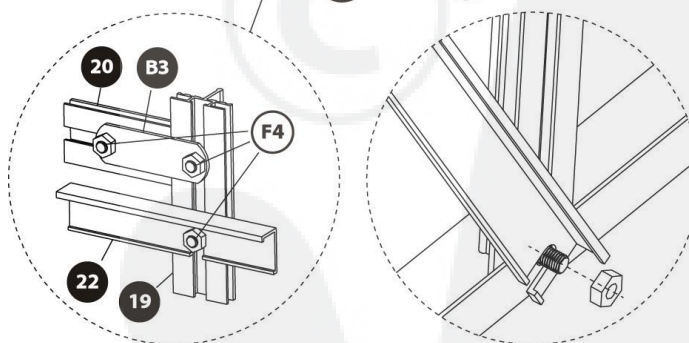
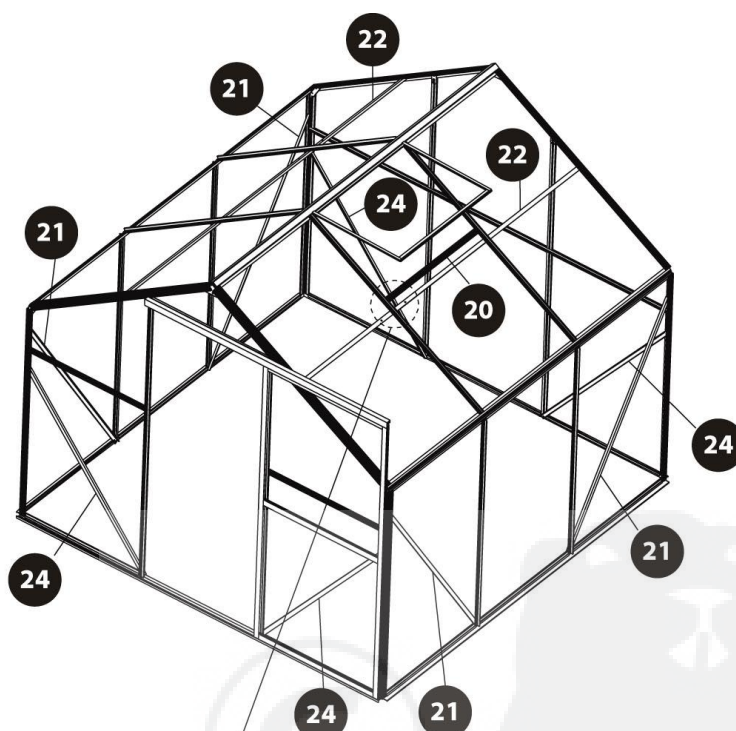



Nota

- Quand la fenêtre est fermée, le guide **W4** est maintenu par **B8**.

Etape 12

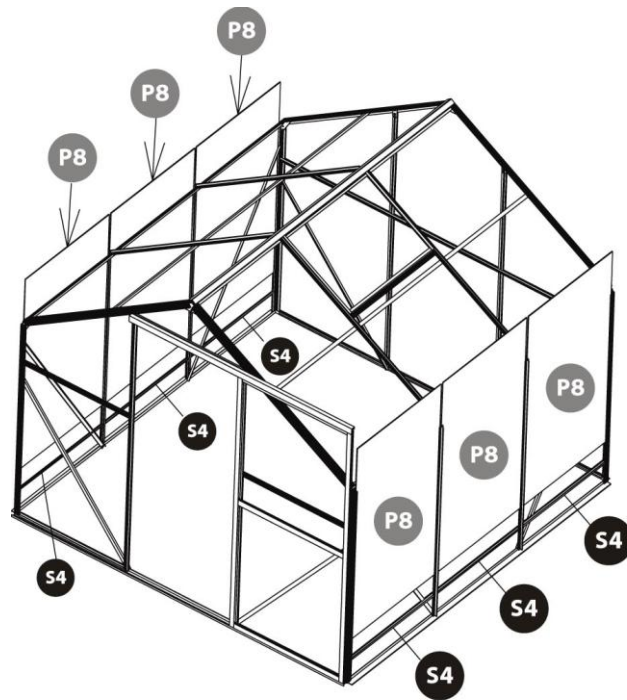
Eléments nécessaires : **S4x6** **P8x6** **P9x5** **P10x1**



PART	NO.	Qty.
	S4	6

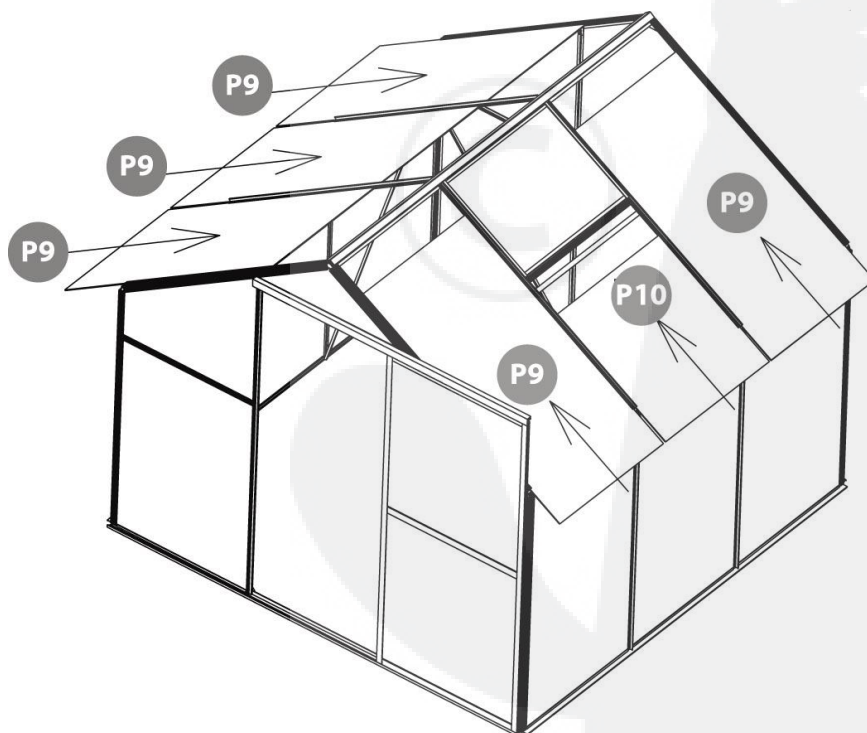

Etape 13

Eléments nécessaires : **23**x2

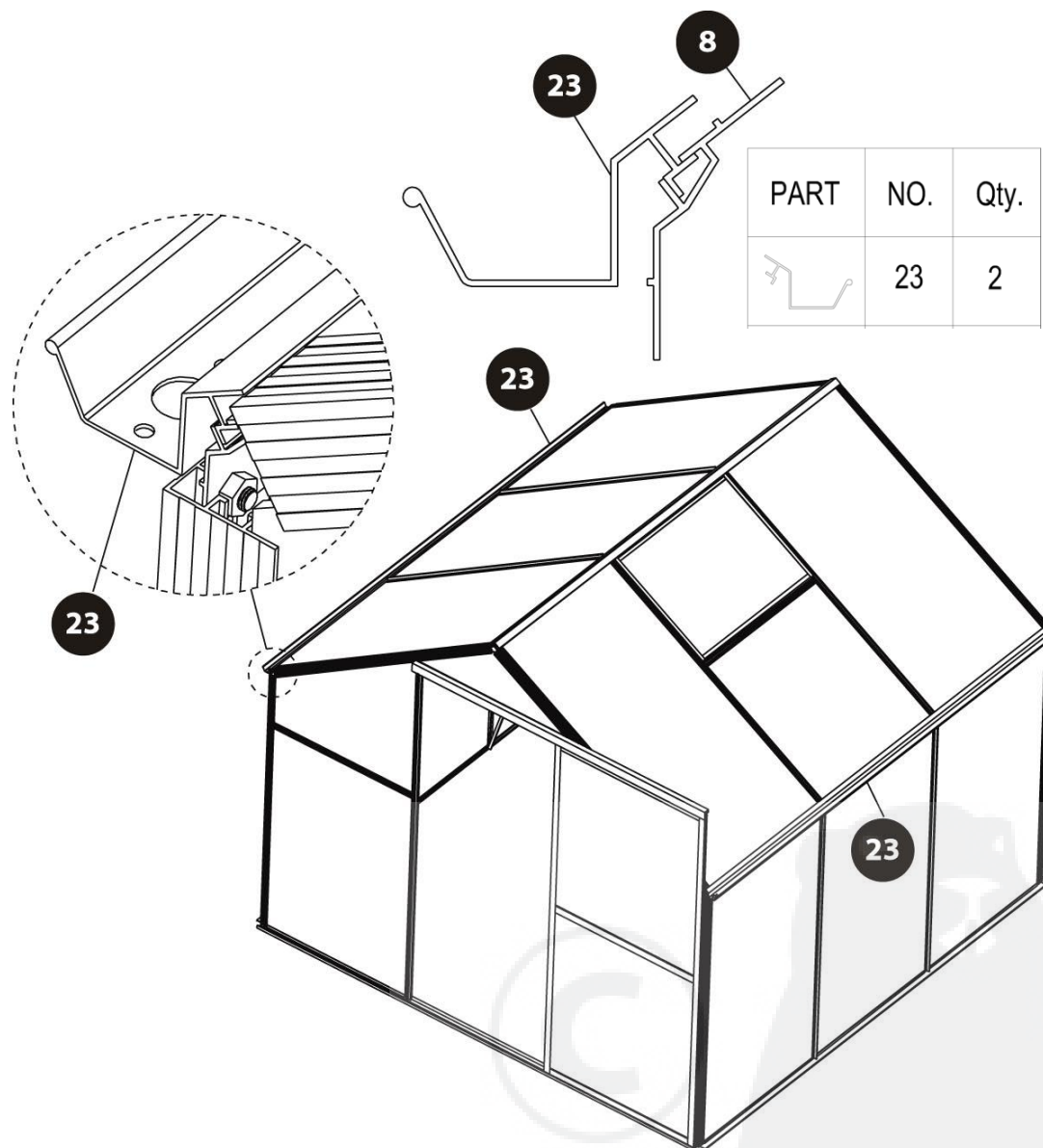

Etape 14

Eléments nécessaires : **S5**x2 **S6L**x2 **S6R**x2 **S7**x2 **F3**x8

PART	NO.	Qty.
	S5	2
	S6R	2
	S6L	2
	S7	2
	F3	8

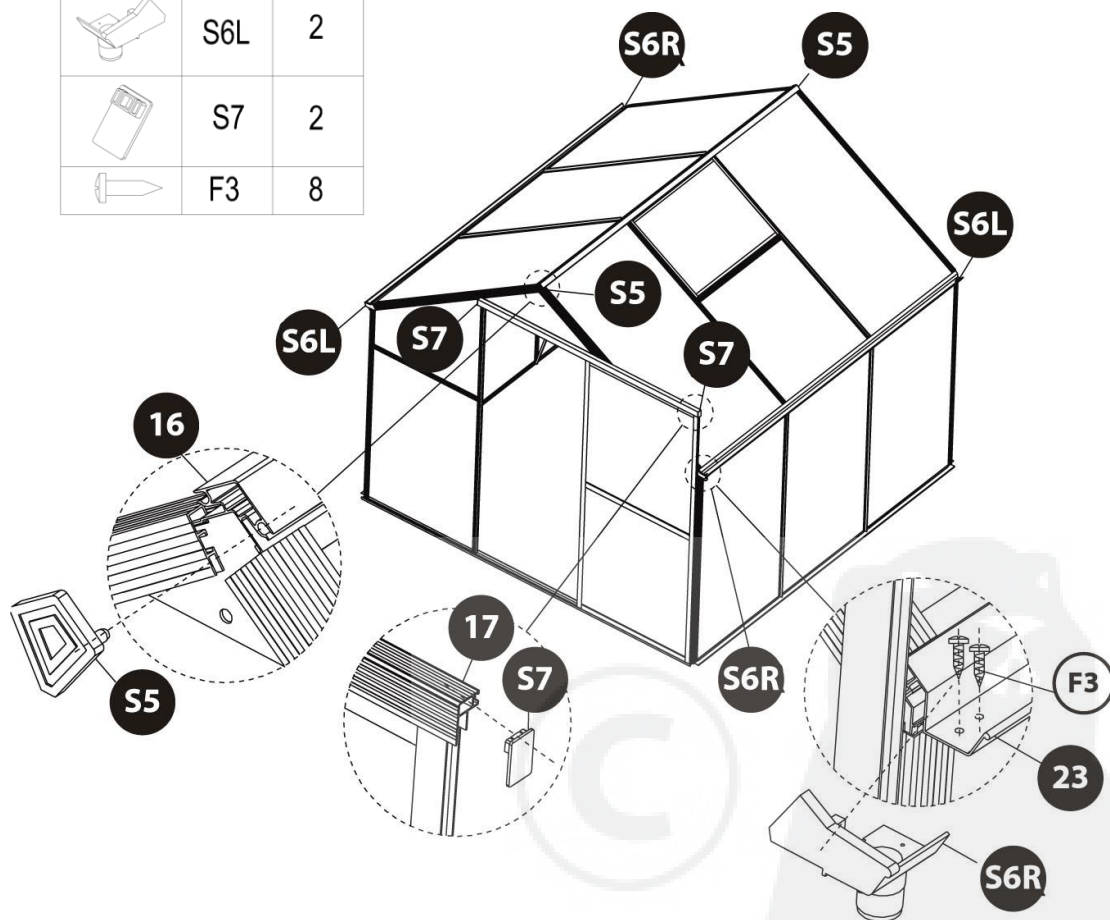



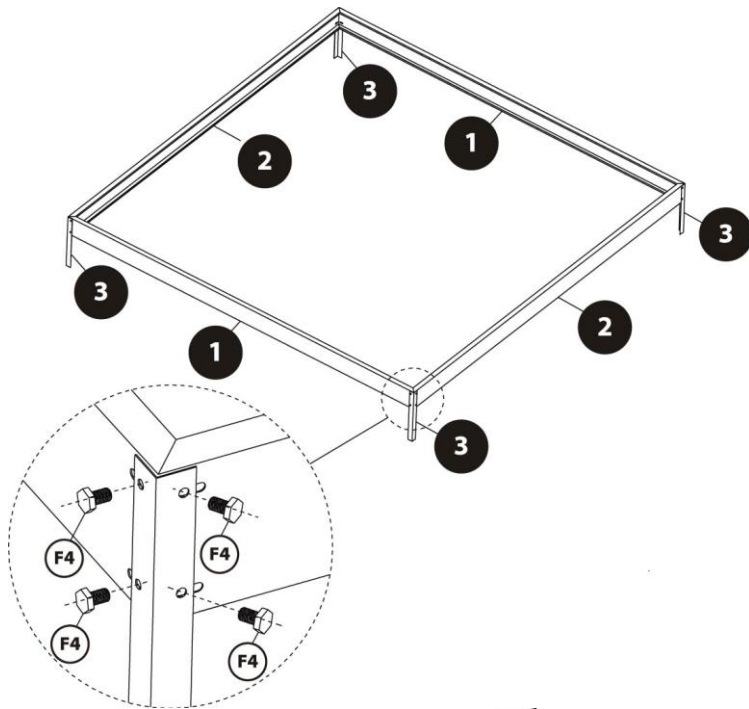

BASE

Etape 15 :

Eléments nécessaires : 1x2 2x2 3x4 F4x16

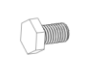

PART	NO.	Qty.
	1	2
	2	2
	3	4
	F4	16

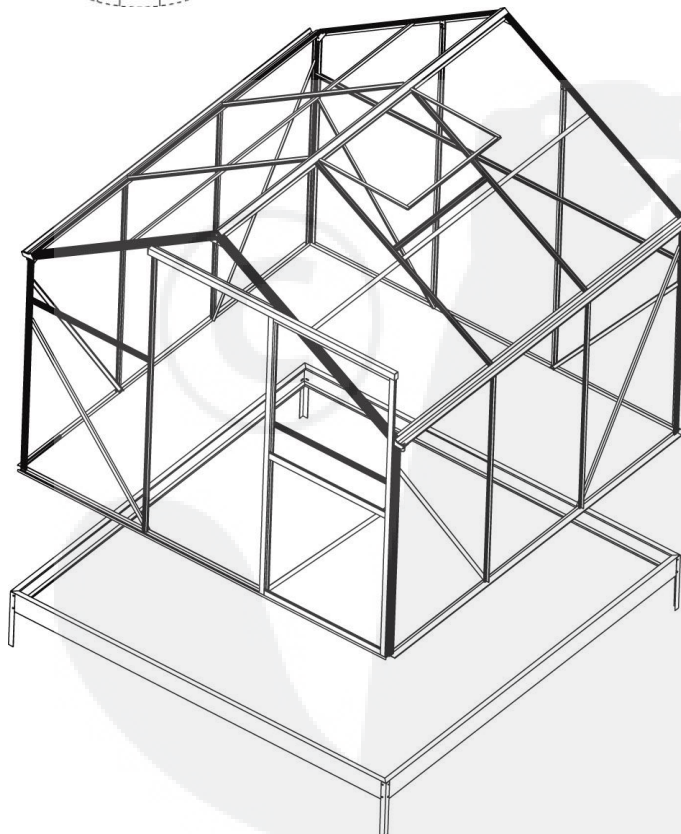

Etape 16

Eléments nécessaires : **B2**x16

PART	NO.	Qty.
	B2	16

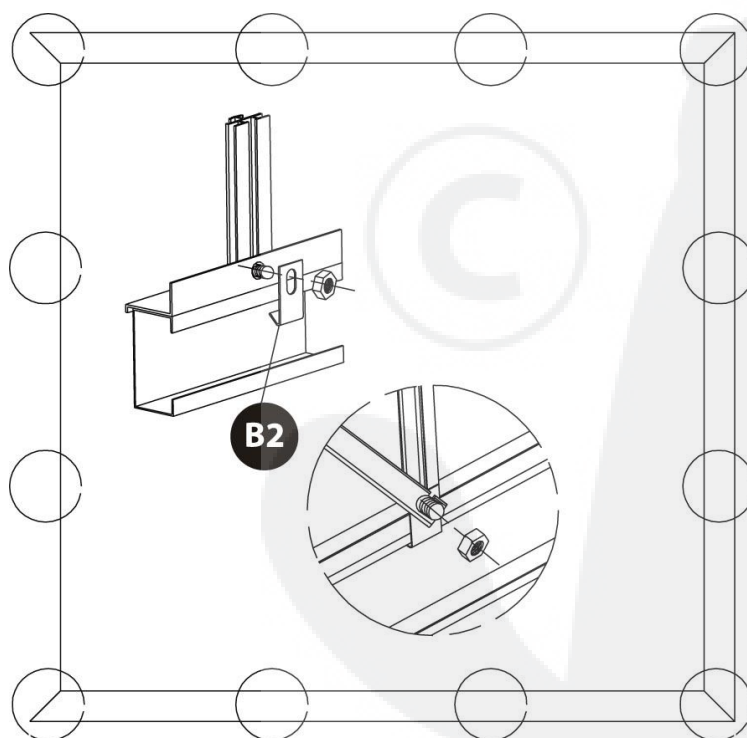
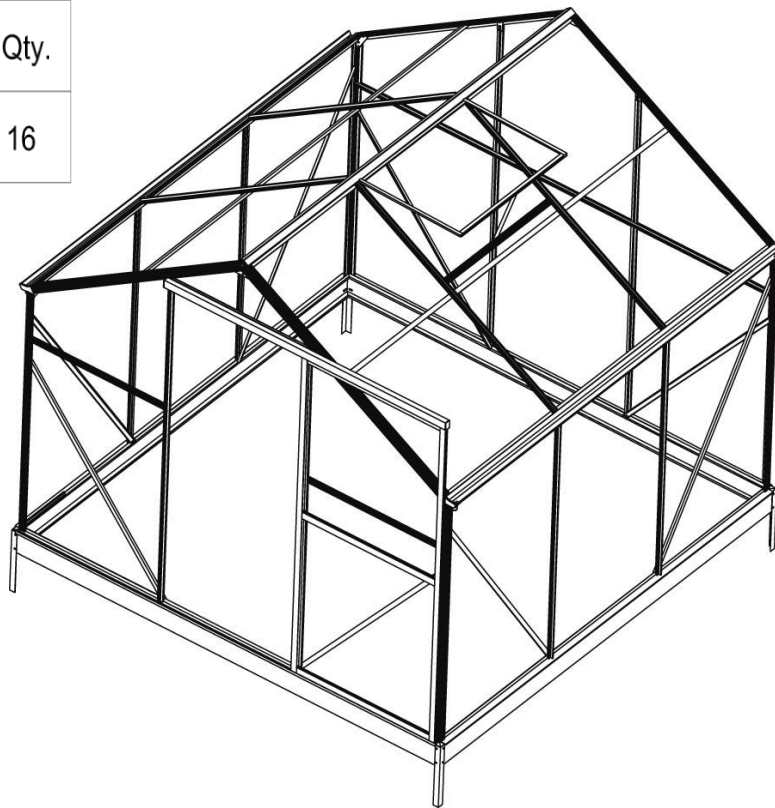

Entretien de la serre

- Pour le nettoyage, préférer un détergent doux et rincez à l'eau froide.
- Ne surtout pas utiliser d'acétone, nettoyant abrasif et/ou détergents spéciaux pour le nettoyage des panneaux en polycarbonate.
- Pour une utilisation optimale, graisser régulièrement avec un gel adapté les glissières et les articulations.
- Si le toit est recouvert de feuilles et/ou neige, dégager ceux-ci pour une meilleure utilisation de la serre.

