







RASENTRAKTOREN
LAWN TRACTORS
Tracteurs de pelouse

Inhaltsverzeichnis
Table of contents
Tables de matières

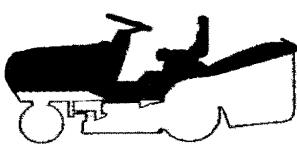
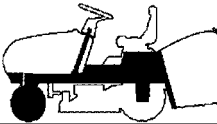
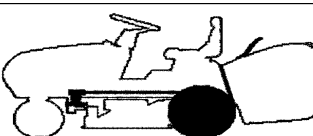

Modelle 2007

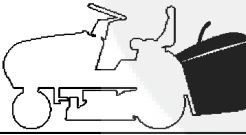
Crossover
102/16 Hydro OHV
Art. 65060

1		KARROSSERIE BODY CARROSSERIE
2		RAHMENSATZ & LENKGETRIEBE CHASSIS & STEERING CHASSIS & BARRE DE DIRECTION
3		GETRIEBE TRANSMISSION TRANSMISSION
4		MOTOR ENGINE MOTEUR
5		SCHNEIDWERK CUTTING PLATE PLATEAU DE COUPE
6		TANK, BATTERIE & KOMPONENTEN TANK, BATTERY & COMPONENTS TANK, BATTERIE & COMPOSANTS
7		GRASFANGSACK KPL. GRASS CATCHER ASSY. BAC COMPOSANTS
8		ELEKTRIK 1 ELECTRIC 1 ELECTRIQUES 1

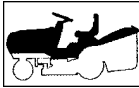

Crossover
102/16 Hydro OHV
 Art. 65060
 2007

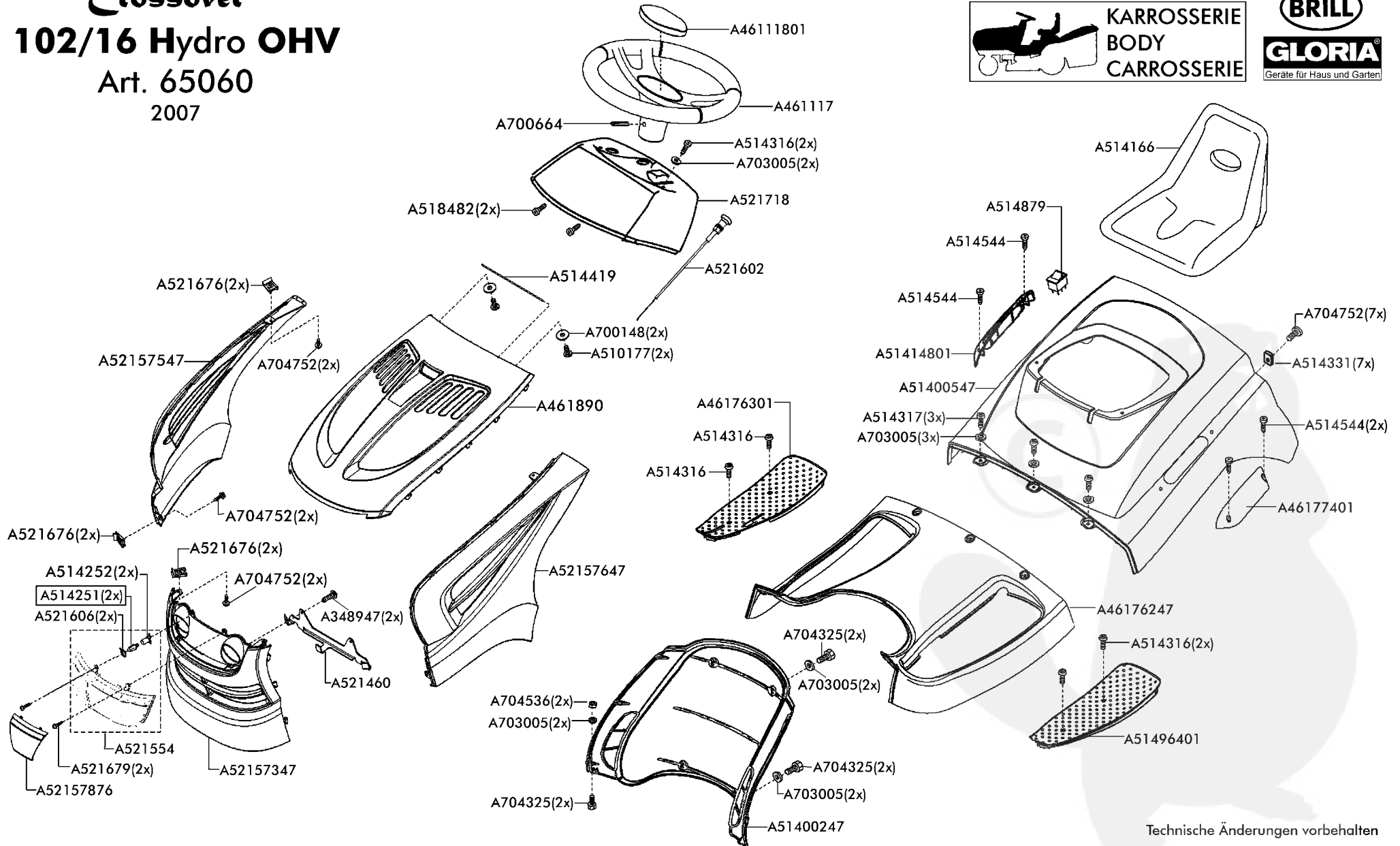
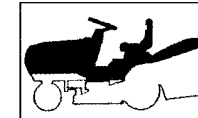

Technische Änderungen vorbehalten

2/22		RASENTRAKTOREN		Crossover			
2007		LAWN TRACTORS		102 / 16 Hydro OHV - Art. 65060			
Rev080102		Tracteurs de pelouse		Modell 2007			
Bild Nr. REF.N° POS.N°	BEST.-NR. PART.-N° N° d. PIECE	BEZEICHNUNG	DESCRIPTION	DÉSIGNATION	Qty.		
1	A348947	SCHRAUBE PT-KB 60X20 1442	SCREW	ECROU	2		
2	A461117	LENKRAD KPL	STEERING WHEEL	VOLANT	1		
3	A46111801	ABDECKKAPPE FÜR LENKRAD R9005	STEERING CAP	BOUCHON	1		
4	A46176247	ABDECKUNG, UNTEN	LOWER COVER PLATE	COUVRE	1		
5	A46176301	TRITTPLATTE RECHTS R9005	RIGHT FOOTBOARD	COUVRE MARCHEPIED DROITE	1		
6	A46177401	ABDECKUNG SCHALTKULISSE FUSSC R9005	BEZEL	BANDEAU	1		
7	A461890	OBERTEIL HAUBE OEM-BRILL ANSAUGHUTZE	UPPER HOOD R7016 65060	CAPOT R7016 65060	1		
8	A510177	SHR PT-KB 60 X14 1411	SCREW KB 60 X14 1411	VIS KB 60 X14 1411	2		
9	A51400247	KONSOLE MOTORHAUBE R6001	CENTRAL DASHBOARD	SUPPORT TABLEAU CENTR.	1		
10	A51400547	MITTELKONSOLE HINTEN R6001	REAR COVER	COUVRE	1		
11	A51414801	ABDECKUNG HÖHENVERSTELLUNG R9005	BEZEL R9005	BANDEAU R9005	1		
12	A514166	SITZ 1	SEAT	SIÈGE	1		
13	A514251	LAMPE XENON 6W	FARILAMP XENON 6W	LAMPE XENON 6W	2		
14	A514252	LAMPENFASSUNG TRAKTOR	LAMP HOLDER	DOUILLE DE LAMPE	2		
15	A514316	SCHRAUBE SFS-TAPT 6X12 2019 A3R	SCREW	VIS	6		
16	A514317	SCHRAUBE SFS.TAPT6X16 2019 A3R	SCREW	ECROU	3		
17	A514331	BLECHMUTTER 4.8 FORM 1 VZ	NUT	ECROU	7		
18	A514419	FEDERSTAHL DRAHT VERZ	ROD	BARRE	1		
19	A514544	SCHRAUBE PT-KB60X30 1411A3R	SCREW	ECROU	4		
20	A514879	SCHALTER JXA2Z00B-AZC00-000-XA	SWITCH	BOUTON	1		
21	A51496401	TRITTPLATTE LINKS 102 R9005	LEFT FOOTBOARD	COUVRE MARCHEPIED GAU.	1		
22	A518482	SCHRAUBE PT-KB50X18 1411	SCREW PT-KB50X18 1411	VIS PT-KB50X18 1411	2		
23	A521460	SCHARNIERBLECH HAUBE	HOOD SUPPORT	CAPOT SUPPORT	1		
24	A521554	SCHEINWERFER KPL HAUBE-4 XENON 6W	FLOOD LIGHT CARTRIDGE ASSY.	PHARE GARNITURE CPL.	1		
25	A52157347	FRONTTEIL HAUBE R6001	FRONT HOOD GREEN	CAPOT VERT	1		
26	A52157547	SEITENTEIL RECHTS HAUBE R6001	SIDE HOOD RIGHT	CAPOT DROITE	1		
27	A52157647	SEITENTEIL LINKS HAUBE R6001	SIDE HOOD LEFT	CAPOT GAUCHE	1		
28	A52157876	FRONTBLLENDE	COVER PLATE	GRILL	1		
29	A521602	CHOKERZUG"CAPRO"	CHOKECONTROL	COMMANDE STARTER	1		
30	A521606	SCHLAUCHKLEMME "REFLEKTOR"	FAIR LED	FIXATION	2		
31	A521676	SCHNAPPMUTTER NU 0921	NUT NU 0921	ECROU NU 0921	6		
32	A521679	SCHRAUBE PT-KB 30X12 WN 5452	SCREW	VIS	2		
33	A521718	BEDIENKONSOLE TAMP Y-SILBER "CHOKER"	DASHBOARD TAMP Y-SILBER "CHOKER"	TABLEAU DE BORD TAMP Y-SILBER "CHOKER"	1		
34	A700148	SCHEIBE 6,4 9021-ST VZ	WASHER	RONDELLE	1		
35	A700664	SPANNHUELSE 8 X 60 1481	COLLET	DOUILLE	1		
36	A703005	SCHEIBE 6,4 9021-ST A3S	WASHER	RONDELLE	11		
37	A704325	SCHRAUBE 6X 40 933- 8.8A3S	SCREW	VIS	6		
38	A704536	MUTTER 6KT 6 985- 8 A3B	NUT	ECROU	2		
39	A704752	SCHRAUBE KO 4,8X16 ZZ-C7981VZ	SCREW	ECROU	13		

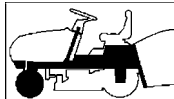

RAHMENSATZ & LENKGETRIEBE
CHASSIS & STEERING
CHASSIS & BARRE DE DIRECTION

Crossover

102 / 16 Hydro OHV - Art. 65060

Modell 2007



Crossover

102/16 Hydro OHV

Art. 65060

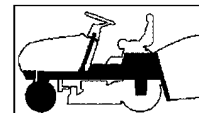

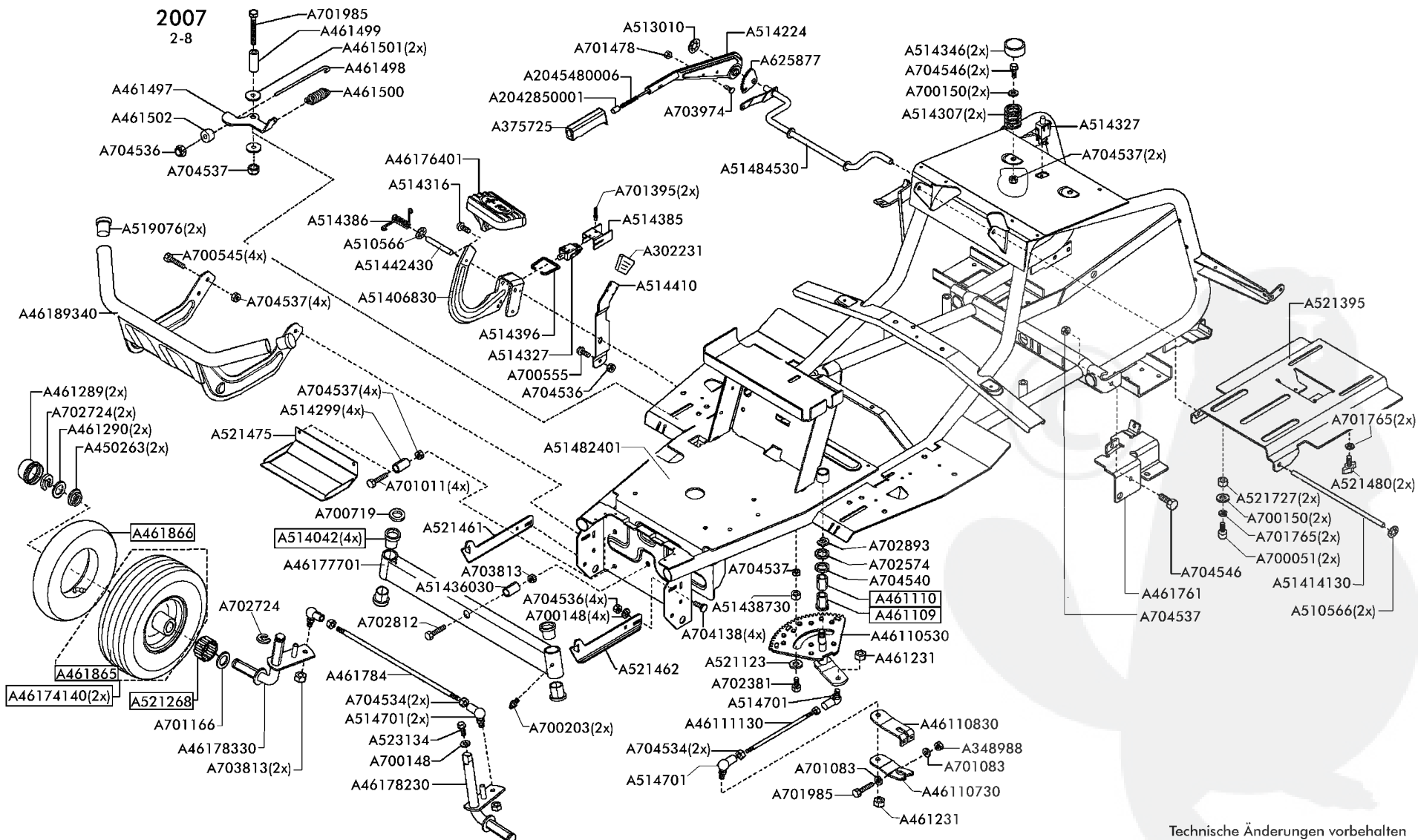

RAHMENSATZ & LENKGETRIEBE
CHASSIS & STEERING
CHASSIS & BARRE DE DIRECTION



Technische Änderungen vorbehalten

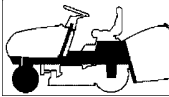

4/22	RASENTRAKTOREN		RAHMENSATZ & LENKGETRIEBE CHASSIS & STEERING CHASSIS & BARRE DE DIRECTION		Crossover	1/3	
2007	LAWN TRACTORS		102 / 16 Hydro OHV - Art. 65060				
Rev080102	Tracteurs de pelouse		Modell 2007				
Bild Nr. REF.N° POS.N°	BEST.-NR. PART-N° N° d. PIECE	BEZEICHNUNG	DESCRIPTION	DÉSIGNATION	Qty.		
1	A2042850001	DRUCKKNOPF F. BR-HEBEL T	BUTTON	POUSSOIR	1		
2	A2045480006	FEDER F. HANDGRIFF T	SPRING	RESSORT	1		
3	A302231	KAPPE R9005	CAP	BONNET	1		
4	A348988	MUTTER SIC- BIW M 8 A3C- 8 MITTELGESICH	NUT	ECROU	1		
5	A375725	HANDGRIFF HOENENVERST. T	KNOB	POIGNEE	1		
6	A450263	BUCHSE TRAKTOR VORDERRAD	BUSH	DOUILLE	2		
7	A46110530	LENKSEGMENT GESCHW VERZ	SEGMENT	SEGMENT GUIDER	1		
8	A46110730	LENKHEBEL 2 TEILIG UNTEN VERZ	LOWER STEERING ARM	LEVIER GUIDER EN BAS	1		
9	A46110830	LENKHEBEL 2 TEILIG OBEN VERZ	UPPER STEERING ARM	LEVIER GUIDER EN HAUT	1		
10	A461109	BUNDBUCHSE LENKUNG	COLLAR BUSH	DOUILLE	1		
11	A461110	BUCHSE	BUSH	DOILLE	1		
12	A46111130	SCHUBSTANGE VERZ	STEERING ROD DIRECTION	LEVIER BARRE DE	1		
13	A461231	MUTTER SIC- BIW M10 A3B- 8	NUT	ECROU	2		
14	A461289	ABDECKKAPPE"TRAKTOR"	HUB COVER	COUVRE MOYEU	2		
15	A461290	SCHEIBE 42MM FÜR TRAKTOR	WASHER	RONDELLE	2		
16	A461497	WIPPE FÜR KUPPLUNG FAHRANTRIEB	ROCKER	BASCULE	1		
17	A461498	ZUGSTANGE FÜR KUPPLUNG FAHRANTRIEB	TENSION ROD	BARRE	1		
18	A461499	ROHR FÜR KUPPLUNG FAHRANTRIEB	TUBE FOR CLUTCH (DRIVE)	TUYAU EMBRAYAGE ENTR.D.ROUE	1		
19	A461500	ZUGFEDER FÜR KUPPLUNG FAHRANTRIEB	SPRING	RESSORT	1		
20	A461501	LAGERSCHEIBE FÜR KUPPLUNG FAHRANTRIEB	DISK	DISQUE	2		
21	A461502	KUGELFÜHRUNG FÜR KUPPLUNG FAHRANTR	GUIDANCE	GUIDAGE	1		
22	A46174140	VORDERRAD 15X6.00-6 BREIT KPL R9006	FRONT WHEEL 15X6.00-6	ROUE AVANT 15X6.00-6	2		
23	A461761	BREMSZUGWIDERLAGER	BRACKET	EQUERRE-SUPPORT	1		
24	A46176401	PEDALAUFLAGE BREMSE UND KUPPL. R9005	CLAMP COVER FRONT	COUVRE ETRIER AVANT	1		
25	A46178230	ACHSSCHENKEL LINKS 15" GESCHW VERZ	LEFT STUB AXLE	FUSEAU GAUCHE	1		
26	A46178330	ACHSSCHENKEL RECHTS 15" GESCHW VERZ	RIGHT STUB AXLE	FUSEAU DROITE	1		
27	A461784	SPURSTANGE 15"	TIE ROD 15"	TIRANT 15"	1		
28	A461865	MANTEL F. REIFEN 15X6,00-6 2PR	SHOE 15X6,00-6 2PR	PNEU 15X6,00-6 2PR	2		
29	A461866	SCHLAUCH 15X6,00-6 TR13	HOSE 15X6,00-6 TR13	TUYAU 15X6,00-6 TR13	2		
30	A46189340	STOSSSTANGE 30 MM LANG R9006 BRILL	BUMPER R9006	PARE-CHOCS	1		
31	A510566	SCHNELLBEFESTIGER 8SXN26	CROWN FASTENER	FIXATEUR A COURONNE	3		
32	A513010	SCHNELLBEFESTIGER 16 SXN27	CROWN FASTENER	FIXATEUR A COURONNE	1		
33	A514042	BUCHSE-ACHSSCHENKEL	BRASS	COUSSINET	4		
34	A51406830	PEDAL RECHTS VERZ	DRIVE PEDAL	PEDALE TRANSMISSION	1		
35	A514224	HEBEL KPL.HÖHENVERSTELLUNG	LEVER	LEVIER	1		
36	A51424130	BEFESTIGUNGSBÜGEL SCHALTUNG VERZ	PLATE	PLAQUE	1		
37	A514299	PENDELANSCHLAG VERZ	BLOCK	BLOC	4		
38	A514307	DRUCKFEDER FÜR SITZ	SPRING	RESSORT	2		

5/22		RASENTRAKTOREN		 RAHMENSATZ & LENKGETRIEBE CHASSIS & STEERING CHASSIS & BARRE DE DIRECTION		Crossover		102 / 16 Hydro OHV - Art. 65060		2/3			
2007		LAWN TRACTORS				Modell 2007							
Rev073804		Tracteurs de pelouse											
Bild Nr. REF.N° POS.N°	BEST.-NR. PART-N° N° d. PIECE	BEZEICHNUNG	DESCRIPTION	DÉSIGNATION	Qty.								
39	A514316	SCHRAUBE SFS-TAPT 6X12 2019 A3R	SCREW	VIS	1								
40	A514327	DRUCKSCHALTER	PRESS SWITCH	INTERRUPTEUR À PRESSION	2								
41	A514346	ABDECKKAPPE D-35 RAL9005	HOOD	PROTECTEUR	2								
42	A51436030	LAGERBUCHSE-VORDERACHSE VERZ	SPACER	ENTRETOISE	1								
43	A514385	SCHALTERHALTER	SUPPORT	SUPPORT	1								
44	A514386	DREHFEDER RECHTS	SPRING	RESSORT	1								
45	A51438730	DISTANZBUCHSE VERZ	SPACER	BAGUE D'ÉCARTEMENT	1								
46	A514396	BÜGEL	CONNECTING PLATE	PAQUE DE CONNEXION	1								
47	A514410	FESTSTELLFEDER RECHTS	SPRING	RESSORT	1								
48	A51442430	LAGERBOLZEN PEDAL VERZ.	PIN	PIVOT	1								
49	A51447701	PENDELACHSE GESCHW R9005	FLOATING AXLE	ABRE OSCILLANT	1								
50	A514701	WINKELGELENK CS16-M10+SIC	JOINT	JOINT	4								
51	A5148240110	RAHMEN 102CM R9005 NACHARBEIT	CHASSIS 102 R9005	CHASSIS 102 R9005	1								
52	A51484530	LAGERWELLE GESCHW VERZ	SHAFT	ARBRE	1								
53	A519076	ROHRSTOPFEN FÜR ROHR 30X2	COVER	BOUCHER	2								
54	A521123	SCHEIBE D50X5	WASHER	RONDELLE	1								
55	A521268	ROLLENLAGER 20X30X55	ROLLER BEARING	COUSSINET	2								
56	A521375	SKT-MUTTER+SPERRZ.1/4"-20 UN 8.8	NUT	ECROU	2								
57	A521395	VERSTELLKONSOLE SITZ GENIETET	PLATE	PLAQUE	1								
58	A521461	ANBINDUNGSBLECH RECHTS	STIFFENING RIGHT	RENFORCEMENT DROITE	1								
59	A521462	ANBINDUNGSBLECH LINKS	BRACKET LEFT	RENFORCEMENT GAUCHE	1								
60	A521475	WÄRMELEITBLECH UNTEN H-4 UND 2 ZYLINDER	LOWER HEAT GUARD	DÉFLECTEUR CHALEUR EN BAS	1								
61	A521480	FLÜGELSCHRAUBE M8X20	SCREW	VIS	2								
62	A521727	DISTANZBUCHSE	SPACER	ENTRETOISE	2								
63	A523134	SFS-TAPT.M6X12 2021 A2K	SCREW	VIS	1								
64	A625877	SEGMENT "FE/ZN 12 F"	STEERING SHAFT	ARBRE DIRECTION	1								
65	A700051	SCHRAUBE 8X 20 912- 8.8 VZ	SCREW 8X 20 912- 8.8 VZ	VIS 8X 20 912- 8.8 VZ	2								
66	A700148	SCHEIBE 6,4 9021-ST VZ	WASHER	RONDELLE	5								
67	A700150	SCHEIBE 8,4 9021-ST VZ	WASHER	RONDELLE	4								
68	A700203	NIPPEL AS 6X1 KEG 71412	GREASE DISPENSER	GRAISSEUR	2								
69	A700545	SCHRAUBE 8X 16 933- 8.8VZ	SCREW 8X 16 933- 8.8VZ	VIS 8X 16 933- 8.8VZ	4								
70	A700555	SCHRAUBE 6X 16 933- 8.8VZ	SCREW	VIS	1								
71	A700719	SCHEIBE 21 433 VZ	WASHER	RONDELLE	1								
72	A701011	SCHRAUBE 8X 50 933- 8.8VZ	SCREW	VIS	4								
73	A701083	SCHEIBE 8,4VZ7349"701083"	WASHER	RONDELLE	1								
74	A701166	SCHEIBE PA 20X28X0,5 988	WASHER	RONDELLE	1								
75	A701395	BLINDNIET 4,0X 8	RIVET	RIVET	2								
76	A701478	MUTTER HUT 5 986- 8 VZ	NUT	ECROU	1								

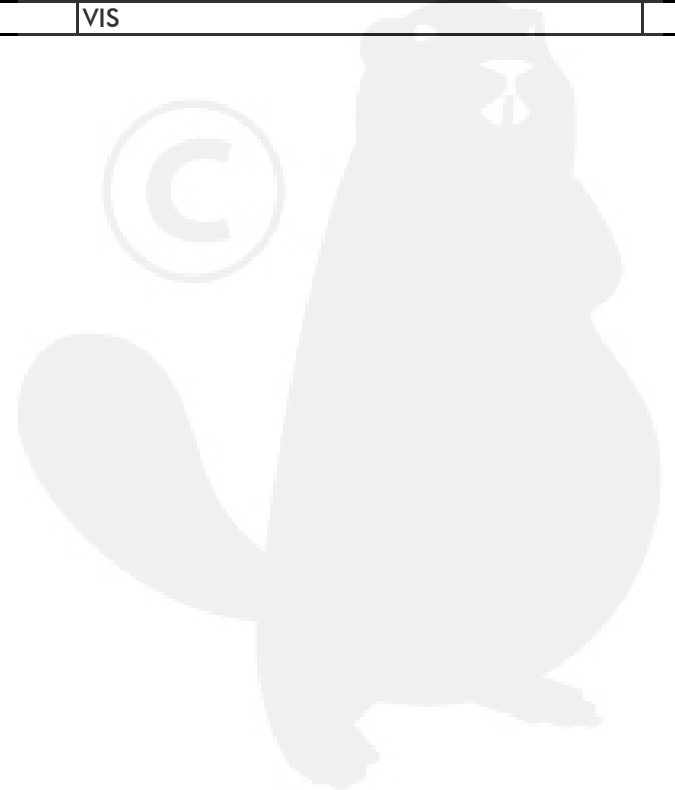
6/22		RASENTRAKTOREN		 RAHMENSATZ & LENKGETRIEBE CHASSIS & STEERING CHASSIS & BARRE DE DIRECTION	Crossover		3/3	
2007		LAWN TRACTORS			102 / 16 Hydro OHV - Art. 65060			
Rev073804		Tracteurs de pelouse			Modell 2007			
Bild Nr. REF.N° POS.N°	BEST.-NR. PART-N° N° d. PIECE	BEZEICHNUNG	DESCRIPTION	DÉSIGNATION	Qty.			
77	A701765	SCHEIBE FÄCHER- A 8,4 6798 VZ	WASHER FÄCHER- A 8,4 6798 VZ	RONDELLE A 8,4 6798 VZ	4			
78	A701985	SCHRAUBE 8X 55 931- 8.8VZ	SCREW	VIS	1			
79	A702381	SCHRAUBE 8X 30 7991- 8.8 VZ	SCREW	VIS	1			
80	A702574	SCHEIBE PA 14X20X1,0 988 VZ	WASHER	RONDELLE	1			
81	A702724	SCHEIBE SICH 15 6799 VZ	WASHER	RONDELLE	3			
82	A702812	SHR10X 55 931- 8.8A3C	SCREW	VIS	1			
83	A702893	SCHEIBE SICH 10 6799 DAC	WASHER	RONDELLE	1			
84	A703813	MUTTER 6KT 10 985-10 A3B	NUT	ECROU	3			
85	A703974	SCHRAUBE 5X 20 965-4.8-H A3B	SCREW	VIS	1			
86	A704138	SCHRAUBE 6X 16 603- 4.6A3B	SCREW	ECROU	4			
87	A704534	MUTTER 10 934- 8 A3B	NUT	ECROU	4			
88	A704536	MUTTER 6KT 6 985- 8 A3B	NUT	ECROU	6			
89	A704537	MUTTER 6KT 8 985- 8 A3B	NUT	ECROU	13			
90	A704540	SCHEIBE A 13 125-ST A3B	WASHER	RONDELLE	1			
91	A704546	SCHRAUBE 8X 20 933- 8.8A3B	SCREW	VIS	3			

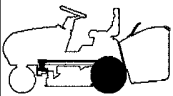

8/22		RASENTRAKTOREN		 GETRIEBE TRANSMISSION TRANSMISSION	Crossover		102 / 16 Hydro OHV - Art. 65060 Modell 2007	1/2	
2007		LAWN TRACTORS							
Rev073804		Tracteurs de pelouse							
Bild Nr. REF.N° POS.N°	BEST.-NR. PART.-N° N° d. PIECE	BEZEICHNUNG	DESCRIPTION	DÉSIGNATION	Qty.				
1	A317280	KABELSCHELLE	CABLE CLIP	COLLIER	2				
2	A321126	MUTTER KASTEN- M 6-ST GALVZ+PASSI	NUT M 6-ST GALVZ+PASSI	ECROU M 6-ST GALVZ+PASSI	2				
3	A46128730	BOXVERRIEGELUNG GESCHW VERZ	BOX LOCKING	BOX DISPOSITIF DE BLOCKAGE	1				
4	A46128830	VERRIEGELUNGSSTANGE VERZ	LOCKING ROD	BARRE DE BLOCKAGE	1				
5	A461289	ABDECKKAPPE"TRAKTOR"	HUB COVER	COUVRE MOYEU	2				
6	A461290	SCHEIBE 42MM FÜR TRAKTOR	WASHER	RONDELLE	2				
7	A461292	RÜCKHOLFEDER BOXVERRIEGELUNG	TENSION SPRING	RESSORT	1				
8	A461429	KLEMMBLECH 51118	CLAMP PLATE	BORNE	1				
9	A461431	MUTTER 5/16" UNC B	NUT	ECROU	2				
10	A461473	ANLAUFSCHLEIBE 52119	WASHER	RONDELLE	2				
11	A461494	DISTANZHÜSLE LINKES RAD HY-GEAR 310-051	SPACER	DOUILLE	1				
12	A461506	BOLZEN	BOLT	BOULLON	2				
13	A46151301	RÜCKWAND 102 R9005	REAR PANEL	PANNEAU ARRIERE	1				
14	A461514	RIEMENFÜHRUNG HINTEN	BELT GUIDE	GUIDE DE COURROIE	1				
15	A461536	MANTEL FÜR REIFEN 18X8,50-8 2PR	SHOE 18X8,50-8 2PR	PNEU 18X8,50-8 2PR	2				
16	A46174830	LAGERBOCK FÜR PEDAL VERZ	BEARING BRACKET	CHEVALET SUPPORT	1				
17	A46175130	PEDAL RÜCKWÄRTS GESCHW VERZ	PEDAL BACKWARD DRIVE	PEDAL EN ARRIÈRE	1				
18	A46175630	VERBINDUNGSSTAB GESCHW VERZ	CONNECTION ROD	BARRE DE CONNEXION	1				
19	A46176030	UMLENKUNG HINTEN GESCHW VERZ	SHAFT ASSY	LEVIER CPL	1				
20	A461766	DURCHFÜHRUNGSTÜLLE	FIXING RING	ANNEAU DE GUIDAGE	1				
21	A461768	GEWINDESTAB	THREAD ROD	TIGE FILETÉE	1				
22	A46177001	DREHMOMENTABSTÜTZUNG FUSSC GES R900	REAR SHAFT ASSY	ARBRE ARRIÈRE	1				
23	A461771	BUCHSE FÜR BREMSHEBEL VERZ	BUSH	DOILLE	1				
24	A461772	BYPASSHEBEL HYDRO FUSSCONTROL	LEVER HYDRO CONTROL	LEVIER CONTROLE HYDRO	1				
25	A461773	GETRIEBE-HYDRO GEAR FUSSC"358-0510"	HYDRO TRANSMISSION ASSY	TRANSMISSION AUTOMATIQUE HYDRO	1				
26	A461788	DÄMPFER 52406	BUFFER	AMORTISSEUR	1				
27	A461789	KUGELKOPF 51426	ADAPTER	ADAPTER	2				
28	A46179001	PEDALAUFLAGE VORWÄRTS HY-FUßS R9005	CLAMP COVER REAR	COUVRE ETRIER ARRIERE	1				
29	A46179101	PEDALAUFLAGE RÜCKWÄRTS HY-FUßS R9005	PEDAL BACKWARD	PEDAL EN ARRIÈRE	1				
30	A461793	PEDAL VORWÄRTS MIT SS HY-FUSSC R9005	PEDAL FORWARD	PEDAL EN AVANCER	1				
31	A461808	SCHRAUBE SKT 5/16" X 16 SELBSTSCHNEID	SCREW	VIS	1				
32	A510434	SCHRAUBE SFS-TAPT.6X20 2016	SCREW	VIS	1				
33	A511249	SCHNELLBEFESTIGER 7SXN26	CROWN FASTENER 7SXN26	FIXATEUR A COURONNE 7SXN26	1				
34	A511693	SCHRAUBE PT-KB 5X10 WN1411 A3B	SCREW	VIS	2				
35	A512725	SCHNELLBEFESTIGER14SXN26	CROWN FASTENER 14SXN26	FIXATEUR A COURONNE 14SXN26	3				
36	A514081	Y-STEHLAGER 3/4"	SUPPORT ASSY	SUPPORT CPL	1				
37	A514157	SCHALT-BOWDENZUG-BREMSE	BOWDEN CABLE	FIL	1				
38	A514239	WINKELGELENK C13SXN68/02R	JOINT	JOINT	2				

9/22		RASENTRAKTOREN		 GETRIEBE TRANSMISSION TRANSMISSION	Crossover		2/2	
2007		LAWN TRACTORS			102 / 16 Hydro OHV - Art. 65060			
Rev073804		Tracteurs de pelouse			Modell 2007			
Bild Nr. REF.N° POS.N°	BEST.-NR. PART-N° N° d. PIECE	BEZEICHNUNG	DESCRIPTION	DÉSIGNATION	Qty.			
39	A514313	PASSFEDER 3/16"X3/16"X2 1/4	FIT-IN KEY	GOUPILLE	2			
40	A514327	DRUCKSCHALTER	PRESS SWITCH	INTERRUPTEUR À PRESSION	1			
41	A514329	MIKROSCHALTER FÜLLSTANDANZEIGE	SWITCH	INTERRUPTEUR	1			
42	A514337	ABDECKTÜLLE FÜR DRUCKSCHALTER	COVER	COUVERCLE PROTECTION	1			
43	A514682	SCHALTHEBEL LANG	LEVER	LEVIER	1			
44	A51486201	LAGERARM RECHTS UNTEN R9005	LOWER BEARING ARM RIGHT	PALIER BRAS DROITE EN BAS	1			
45	A51486301	LAGERARM RECHTS OBEN R9005	UPPER BEARING ARM RIGHT	PALIER BRAS DROITE EN HAUT	1			
46	A51486401	LAGERARM LINKS UNTEN R9005	LOWER BEARING ARM LEFT	PALIER BRAS GAUCHE EN BAS	1			
47	A51486701	LAGERARM LINKS OBEN R9005	UPPER BEARING ARM LEFT	PALIER BRAS GAUCHE EN HAUT	1			
48	A514882	FAHRANTRIEBSRIEMEN 102 HD	DRIVE BELT 102 HD	COURROIE 102 HD	1			
49	A514942	VERRIEGELUNGSKNOPF R9005	ARRESTOR KNOB	BOUTON DE PRESSION ARRE.	1			
50	A521339	FÜLLSTANDSUMMERGEHÄUSE UND HEBEL	PROTECTION COVER & LEVER CPL	COUVERCLE PROTECTION & LEVIER CPL	1			
51	A52185340	HINTER-RAD 18X8.5-8 BREIT KPL R9006	REAR WHEEL CPL 18X8.5-8	ROUE ARRIERE CPL 18X8.5-8	2			
52	A523134	SFS-TAPT.M6X12 2021 A2K	SCREW	VIS	2			
53	A526521	SCHNELLBEFESTIGER 3SXN26	CROWN FASTENER	FIXATEUR A COURONNE	2			
54	A546222	SCHLAUCH 18"X8.5"-8 / 9.50-8 TR13	HOSE 18"X8.5"-8 / 9.50-8 TR13	TUYAU 18"X8.5"-8 / 9.50-8 TR13	2			
55	A700128	RG FED- B 8 127 VZ	LOCK WASHER	DISQUE DE RESSORT	2			
56	A700137	SCHEIBE A 6,4 125-ST VZ	WASHER	RONDELLE	6			
57	A700148	SCHEIBE 6,4 9021-ST VZ	WASHER	RONDELLE	1			
58	A700150	SCHEIBE 8,4 9021-ST VZ	WASHER	RONDELLE	15			
59	A700303	SCHRAUBE 8X 70 931- 8.8VZ	SCREW	VIS	2			
60	A700555	SCHRAUBE 6X 16 933- 8.8VZ	SCREW	VIS	2			
61	A700661	HUEL SPAN 6 X 20 1481	BUSHING	DOUILLE	2			
62	A700702	SCHRAUBE 6X 25 933- 8.8VZ	SCREW	VIS	2			
63	A700844	SCHRAUBE 8X 20 603- 4.6VZ	SCREW	VIS	4			
64	A700967	SCHRAUBE 8X 35 603- 4.6VZ	SCREW	VIS	2			
65	A701375	SCHRAUBE 6X 12 7985- 4.8-H VZ	SCREW 8X 25 933- 8.8A3B	VIS 8X 25 933- 8.8A3B	2			
66	A701521	SCHRAUBE 8X 40 933- 8.8VZ	SCREW	VIS	1			
67	A702724	SCHEIBE SICH 15 6799 VZ	WASHER	RONDELLE	2			
68	A703892	SCHRAUBE 8X 45 933- 8.8A3B	SCREW	VIS	6			
69	A704263	SCHEIBE S 19X26X1,5 988A3C	WASHER	RONDELLE	4			
70	A704272	SCHEIBE PA 8X14X1,0 988	WASHER	RONDELLE	2			
71	A704533	MUTTER 8 934- 8 A3B	NUT	ECROU	2			
72	A704536	MUTTER 6KT 6 985- 8 A3B	NUT	ECROU	8			
73	A704537	MUTTER 6KT 8 985- 8 A3B	NUT	ECROU	26			
74	A704538	SCHEIBE A 8,4 125-ST A3B	WASHER	RONDELLE	2			
75	A704545	SCHRAUBE 8X 25 933- 8.8A3B	SCREW 8X 25 933- 8.8A3B	VIS 8X 25 933- 8.8A3B	1			
76	A704546	SCHRAUBE 8X 20 933- 8.8A3B	SCREW	VIS	6			
77	A704744	SCHRAUBE 8X 65 931- 8.8A3B	SCREW	VIS	2			
78	A705322	SPLINT 2 X 20 94 A3B	SPLINT	AUBIER	1			

11/22		RASENTRAKTOREN		Crossover		1/2				
2007		LAWN TRACTORS		102 / 16 Hydro OHV - Art. 65060						
Rev073804		Tracteurs de pelouse		Modell 2007						
Bild Nr. REF.N° POS.N°		BEST.-NR. PART.-N° N° d. PIECE		BEZEICHNUNG		DESCRIPTION		DÉSIGNATION		Qty.
				MOTOR		ENGINE		MOTEUR		
1	A321126	MUTTER KASTEN- M 6-ST GALVZ+PASSI		NUT M 6-ST GALVZ+PASSI		ECROU M 6-ST GALVZ+PASSI				2
2	A348988	MUTTER SICHERUNG BIW M 8 A3C- 8 MITTELGESICHERUNG		NUT		ECROU				5
3	A375953	SCHRAUBE 8X 40 VERBUS RIPP		SCREW		VIS				3
4	A46149301	RIEMENFÜHRUNG HD102 GESCHW R9005		BELT GUIDE		GUIDAGE COURROIE				1
5	A461522	KRÜMMER LINKS HONDA 2-ZYLINDER GESCHW		EXHAUST CONNECTING TUBE LEFT GCV530		TUBE DE CONNEXION GAUCHE GCV530				1
6	A461524	KRÜMMER RECHTS HONDA 2-ZYLINDER GESCHW		EXHAUST CONNECTING TUBE RIGHT GCV530		TUBE DE CONNEXION DROITE GCV530				1
7	A461631	MOTOR HONDA GCV 530-SE-E2-SD		MOTOR HONDA GCV 530-SE-E2-SD		MOTOR HONDA GCV 530-SE-E2-SD				1
8	A461637	LUFTLEITBLECH HONDA GCV 530		AIR GUIDE HONDA GCV 530		DÉFLECTEUR HONDA GCV 530				1
9	A461894	ABWEISBLECH		PLATE		PLATEAU				1
10	A500207	SCHRAUBE 8X 50 VERBUS RIPP A3R 8.8		SCREW		VIS				1
11	A51421630	ZENTRIERHÜLSE VERZ.		BUSHING		DOILLE				3
12	A514394	RIEMENFÜHRUNG VERZ		BELT GUIDE		GUIDAGE COURROIE				1
13	A514398	ÖSE-RIEMENFÜHRUNG MITTE		BELT GUIDE		GUIDAGE				1
14	A51461810	DICHTUNG TECNA-NR.35-414		SEAL TECNA-NR.35-414		JOINT TECNA-NR.35-414				2
15	A514716	SPANNROLLE INNEN +LAGER		TENSIONER INSIDE ASSY		ROUE SERRAGE				1
16	A514717	SPANNROLLE AUSSEN+LAGER		TENSION ROLL ASSY. OUTSIDE		ROUE SERRAGE À L'EXTÉRIEUR				1
17	A51480430	DISTANZBUCHSE WIPPE VERZ		SPACER		ENTRETOISE				1
18	A51485730	ANTRIEBSSEGMENT BBC 102 GESCHW VERZ		PULLEY		POULIE				1
19	A514943	PASSFEDER 1/4"X1/4"X1"A		FIT-IN KEY		GOUPILLE				1
20	A514944	SCHRAUBE UNF 7/16"X3" 10.9		SCREW		VIS				1
21	A51494830	RIEMENFÜHRUNG FAHRANTRIEB GESCHW VERZ		BELT GUIDE		GUIDE DE COURROIRE				1
22	A514957	FÜHRUNGSBLECH 5-GANG 102		PLATE		GUIDAGE				1
23	A52109630	SPANNROLLENWIPPE D16 GESCHW VERZ		LEVER D16		LEVIER D16				1
24	A521391	UMLENKROLLE ALU+LAGER		PULLEY ASSY		POULIE GUIDAGE CPL				3
25	A521469	AUSPUFFHALTEBLECH		SUPPORT		SUPPORT				1
26	A521475	WÄRMELEITBLECH UNTEN H-4 UND 2 ZYLINDER		LOWER HEAT GUARD		DÉFLECTEUR CHALEUR EN BAS				1
27	A52147630	LUFTLEITBLECH 2-ZYLINDER VERZ		AIR GUIDE		DÉFLECTEUR				1
28	A521683	AUSPUFF 2-ZYLINDER NELSON		MUFFLER		SILENCIEUX NELSON CPL				1
29	A521684	BBC-102 2-ZYLINDER I-5217-8F		ELECTRIC CLUTCH ASSY.		EMBRAYAGE MAGNÉTIQUE CPL				1
30	A522087	ZUGFEDER-BBC		SPRING		RESSORT				1
31	A523134	SFS-TAPT.M6X12 2021 A2K		SCREW		VIS				6
32	A700148	SCHEIBE 6,4 9021-ST VZ		WASHER		RONDELLE				4
33	A700150	SCHEIBE 8,4 9021-ST VZ		WASHER		RONDELLE				3
34	A700483	SCHRAUBE 6X 12 933- 8.8VZ		SCREW		VIS				6
35	A700545	SCHRAUBE 8X 16 933- 8.8VZ		SCREW 8X 16 933- 8.8VZ		VIS 8X 16 933- 8.8VZ				2
36	A700573	SCHRAUBE 6X 20 603- 4.6VZ		SCREW		VIS				2
37	A700656	FED TEL 28 X10,2X1,25 2093		DISK SPRING		DISQUE				1

12/22		RASENTRAKTOREN		Crossover		102 / 16 Hydro OHV - Art. 65060		2/2		BRILL GLORIA <small>Quality for Today and Tomorrow</small>	
2007		LAWN TRACTORS		MOTOR ENGINE		102 / 16 Hydro OHV - Art. 65060					
Rev073804		Tracteurs de pelouse		MOTEUR		Modell 2007					
Bild Nr. REF.N° POS.N°	BEST.-NR. PART-N° N° d. PIECE	BEZEICHNUNG	DESCRIPTION	DÉSIGNATION	Qty.						
38	A700798	MUTTER 6KT 6 980-V- 8	NUT	ECROU	4						
39	A701011	SCHRAUBE 8X 50 933- 8.8VZ	SCREW	VIS	1						
40	A70108310	SCHEIBE 8,4VZ7349"701083"	WASHER	RONDELLE	1						
41	A701171	SCHRAUBE 8X 30 933- 8.8VZ	SCREW	VIS	1						
42	A701521	SCHRAUBE 8X 40 933- 8.8VZ	SCREW	VIS	1						
43	A701765	SCHEIBE FÄCHER- A 8,4 6798 VZ	WASHER FÄCHER- A 8,4 6798 VZ	RONDELLE A 8,4 6798 VZ	5						
44	A702477	SCHRAUBE 8X 80 931- 8.8VZ	SCREW	VIS	2						
45	A704536	MUTTER 6KT 6 985- 8 A3B	NUT	ECROU	2						
46	A704537	MUTTER 6KT 8 985- 8 A3B	NUT	ECROU	12						
47	A704538	SCHEIBE A 8,4 125-ST A3B	WASHER	RONDELLE	3						
48	A704546	SCHRAUBE 8X 20 933- 8.8A3B	SCREW	VIS	4						



MOTOR
ENGINE
MOTEUR





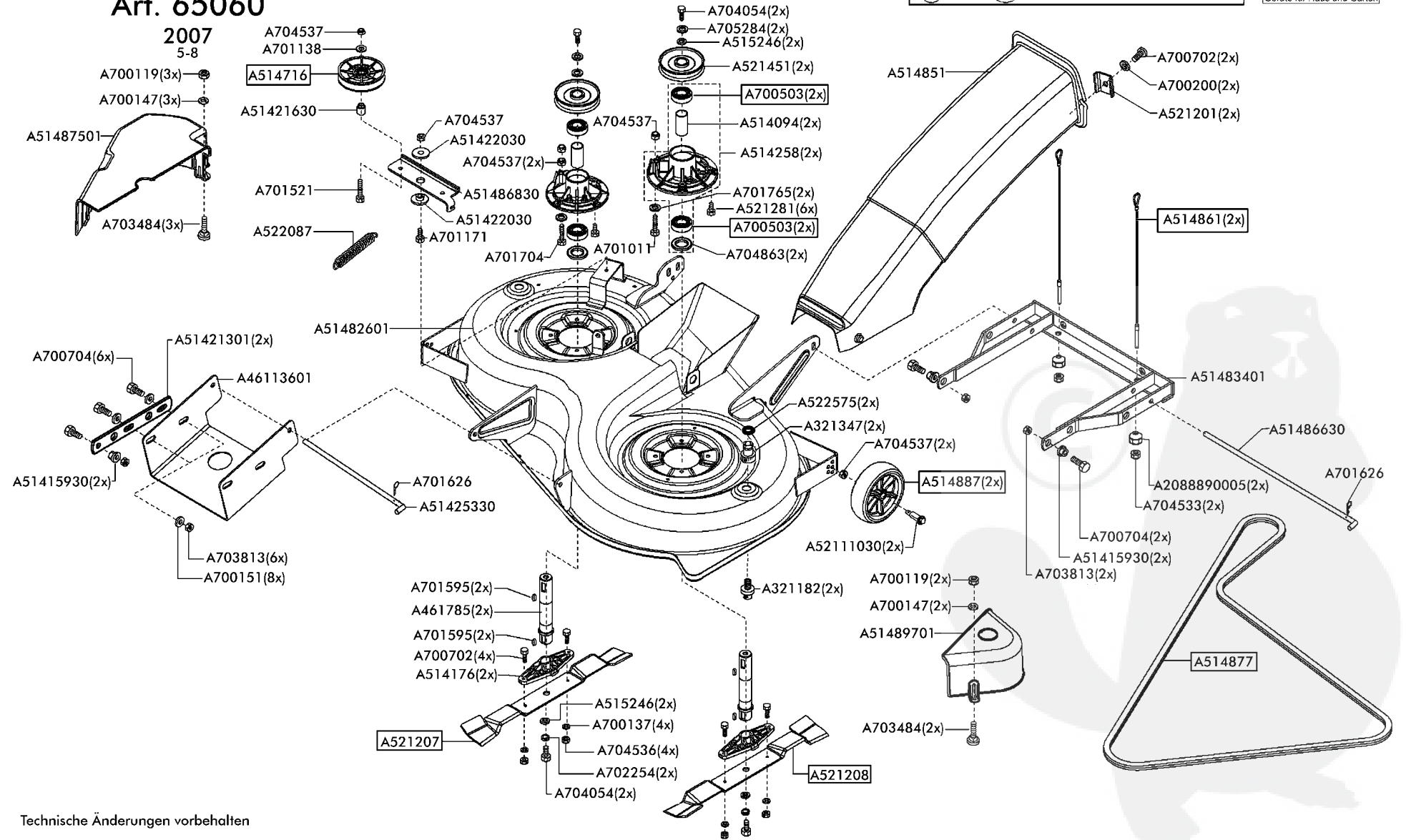

Crossover
102/16 Hydro OHV
 Art. 65060

SCHNEIDWERK
CUTTING PLATE
PLATEAU DE COUPE



Technische Änderungen vorbehalten

14/22	RASENTRAKTOREN		SCHNEIDWERK CUTTING PLATE PLATEAU DE COUPE	Crossover	102 / 16 Hydro OHV - Art. 65060	1/2	
2007	LAWN TRACTORS						
Rev073804	Tracteurs de pelouse				Modell 2007		
Bild Nr. REF.N° POS.N°	BEST.-NR. PART.-N° N° d. PIECE	BEZEICHNUNG	DESCRIPTION	DÉSIGNATION	Qty.		
1	A2088890005	KUGELMUTTER M8	NUT	ECROU	2		
2	A321182	SPÜLDÜSE R1/2"	WATER HOSE CONNECTION	RACCORD TUYAU D'EAU	2		
3	A321347	ANSCHLUSS R1/2"	TUBE ADAPTER R1/2"	ADAPTER TUYAU R1/2"	2		
4	A46113601	MÄHDECKAUFHÄNGUNG VORNE R9005	CUTTING PLATE SUPPORT FRONT	PLATEAU SUSPENSION L'AVANT	1		
5	A461785	MESSERWELLE TRAKTOR VERZ	BLADE SHAFT	ABRE	2		
6	A514094	DISTANZBUCHSE-1	SPACER	ENTRETOISE	2		
7	A51415930	DISTANZSCHEIBE VERZ	SPACER	ENTRETOISE	4		
8	A514176	MESSERHALTER	BLADE FLANGE	BRIDE	2		
9	A51421301	SCHENKEL-VORNE HÖHENVERSTELLUNG R9005	SUPPORT	SUPPORT	2		
10	A51421630	ZENTRIERHÜLSE VERZ.	BUSHING	DOILLE	1		
11	A51422030	DISTANZSCHEIBE VERZ	SPACER	ENTRETOISE	2		
12	A51425330	ABSTECKSTANGE VERZ.	ROD	BARRE	1		
13	A514258	LAGERBOCK KPL.	BLADE FLANGE ASSY. CPL	ENS. BRIDE POUR LAME CPL	2		
14	A514716	SPANNROLLE INNEN +LAGER	TENSIONER INSIDE ASSY	ROUE SERRAGE	1		
15	A51482601	SCHNEIDGEHÄUSE 102 GESCHW R9005	CUTTING CHASSIS 102	PLATEAU DE COUPE	1		
16	A51483401	AUFHÄNGUNG HINTEN 102 GESCHW R9005	REAR FRAME	SUSPENSION ARRIÈRE 102	1		
17	A514851	AUSWURFKANAL TRAKTOR 102	FUNNEL ASSY	BUSE EJECTER CPL	1		
18	A514861	DRAHTSEIL	STEEL WIRE ROPE	CABLE D'ACIER	2		
19	A51486630	ABSTECKSTANGE HINTEN VERZ	ROD	BARRE	1		
20	A51486830	SPANNWIPPE BBC VZKT	SUPPORT	SUPPORT	1		
21	A51487501	ABDECKUNG MÄHANTRIEB RECHTS R9005	BELT COVER RIGHT R9005	BARRIÈRE DROITE CPL	1		
22	A514877	MÄHANTRIEBSRIEMEN 102	V-BELT 102	COURROIE 102	1		
23	A514887	RAD 125 R9005	WHEEL 125 CPL	ROUE CPL 125	2		
24	A51489701	ABDECKUNG MÄHANTRIEB LINKS R9005	BELT COVER LEFT	BARRIÈRE GAUCHE CPL	1		
25	A515246	SCHEIBE 30/10,5 X 5	WASHER	RONDELLE	4		
26	A52111030	RADBOLZEN 102 VERZ	WHEEL BOLT	BOULLON ROUE	2		
27	A521201	FIXIERUNGSSCHEIBE 102	FIXING PLATE	PLATEAU FIXATION	2		
28	A521207	FLÜGELMESSER RECHTS TR-102	WING BLADE RIGHT 102	LAME DROITE 102	1		
29	A521208	FLÜGELMESSER LINKS TR-102	WING BLADE LEFT 102	LAME GAUCHE 102	1		
30	A521281	SCHRAUBE-TAPT 8X25 SPERRZ.A3S	SCREW	VIS	6		
31	A521451	RIEMENSCHLEIBE VERSCHRAUBT 102 KPL	PULLEY ASSY	POULIE	2		
32	A522087	ZUGFEDER-BBC	SPRING	RESSORT	1		
33	A522575	O-RING D10,78X2,62 NBR	O-RING	O-RING	2		
34	A700119	MUTTER 6KT 5 985- 8 VZ	NUT	ECROU	5		
35	A700137	SCHEIBE A 6,4 125-ST VZ	WASHER	RONDELLE	4		
36	A700147	SCHEIBE 5,3 9021-ST VZ	WASHER	RONDELLE	5		
37	A700151	SCHEIBE 10,5 9021-ST VZ	WASHER	RONDELLE	8		
38	A700200	SCHEIBE FÄCHER- J 6,4 6798 VZ	WASHER	RONDELLE	2		

15/22	RASENTRAKTOREN		SCHNEIDWERK CUTTING PLATE PLATEAU DE COUPE	Crossover 102 / 16 Hydro OHV - Art. 65060 Modell 2007	2/2	
2007	LAWN TRACTORS					
Rev073804	Tracteurs de pelouse					
Bild Nr. REF.N° POS.N°	BEST.-NR. PART-N° N° d. PIECE	BEZEICHNUNG	DESCRIPTION	DÉSIGNATION	Qty.	
39	A700503	KUGELLAGER 6205 2RS 625	BALL BEARING	ROULEMENT À BILLES	4	
40	A700702	SCHRAUBE 6X 25 933- 8.8VZ	SCREW	VIS	6	
41	A700704	SCHRAUBE10X 30 933- 8.8VZ	SCREW	VIS	9	
42	A701011	SCHRAUBE 8X 50 933- 8.8VZ	SCREW	VIS	1	
43	A701138	SCHRAUBE ST4,2X13 -C-H7981 VZ	SCREW	VIS	1	
44	A701171	SCHRAUBE 8X 30 933- 8.8VZ	SCREW	VIS	1	
45	A701521	SCHRAUBE 8X 40 933- 8.8VZ	SCREW	VIS	1	
46	A701595	PASSFEDER 8X7X20 6885	FIT-IN KEY	GOUPILLE	4	
47	A701626	FEDERSTECKER - 2,5 11024 VZ	COTTER PIN	GOUPILLE	2	
48	A701704	SCHRAUBE 8X 60 933- 8.8VZ	SCREW	VIS	1	
49	A701765	SCHEIBE FÄCHER- A 8,4 6798 VZ	WASHER FÄCHER- A 8,4 6798 VZ	RONDELLE A 8,4 6798 VZ	2	
50	A702254	SCHEIBE FÄCHER- A 10,5 6798 VZ	WASHER	RONDELLE	2	
51	A703484	SCHRAUBE 5X 16 603- 4.6A3C	SCREW	VIS	5	
52	A703813	MUTTER 6KT 10 985-10 A3B	NUT	ECROU	8	
53	A704054	SCHRAUBE10X1,0 X 35 961- 8.8	SCREW	VIS	4	
54	A704533	MUTTER 8 934- 8 A3B	NUT	ECROU	2	
55	A704536	MUTTER 6KT 6 985- 8 A3B	NUT	ECROU	4	
56	A704537	MUTTER 6KT 8 985- 8 A3B	NUT	ECROU	7	
57	A704863	RWDR AS 30X 52X 5 3760-NB	WASHER	RONDELLE	2	
58	A705284	TELLERFEDER 28 X10,2X1,5 2093	DISK SPRING	RESSORT D'ASSIETTE	2	

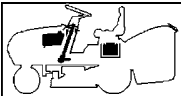

TANK, BATTERIE & KOMPONENTEN
 TANK, BATTERY & COMPONENTS
 TANK, BATTERIE & COMPOSANTS

Crossover

102 / 16 Hydro OHV - Art. 65060
 Modell 2007



Crossover
102/16 Hydro OHV
 Art. 65060
 2007
 6-8

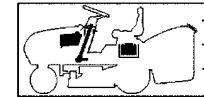

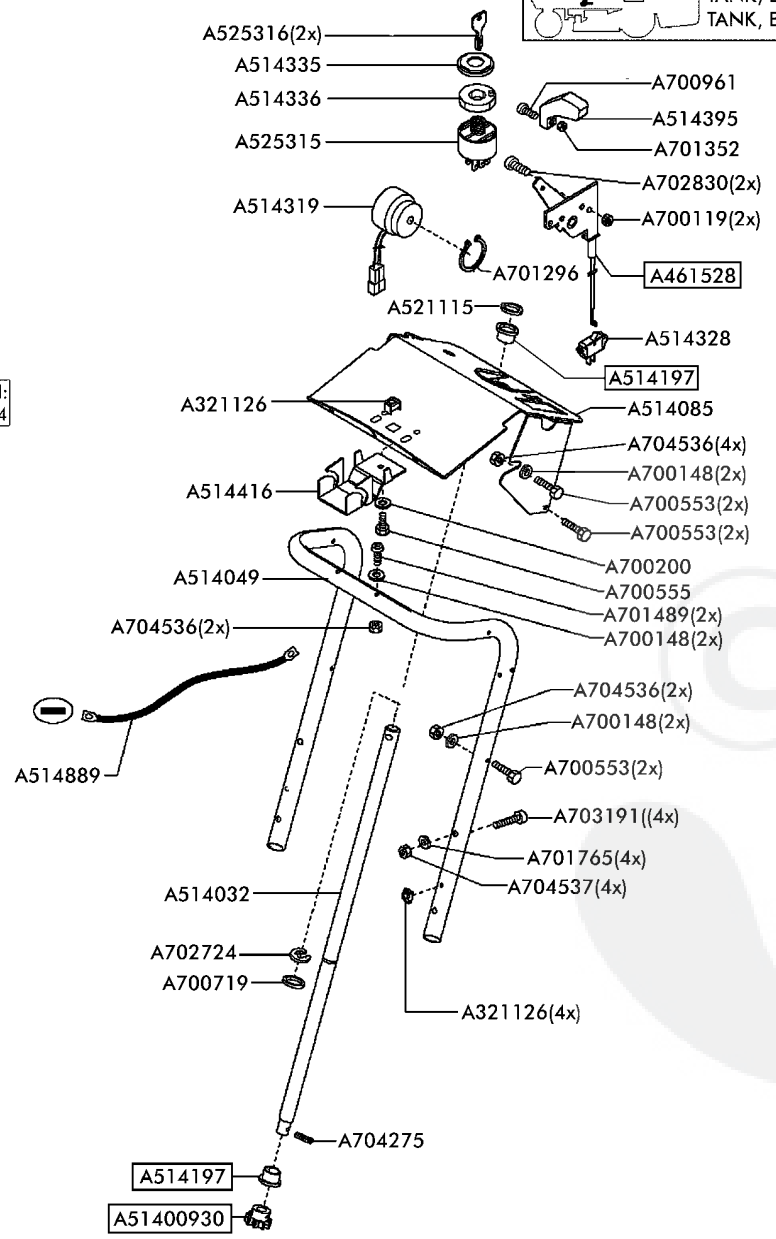
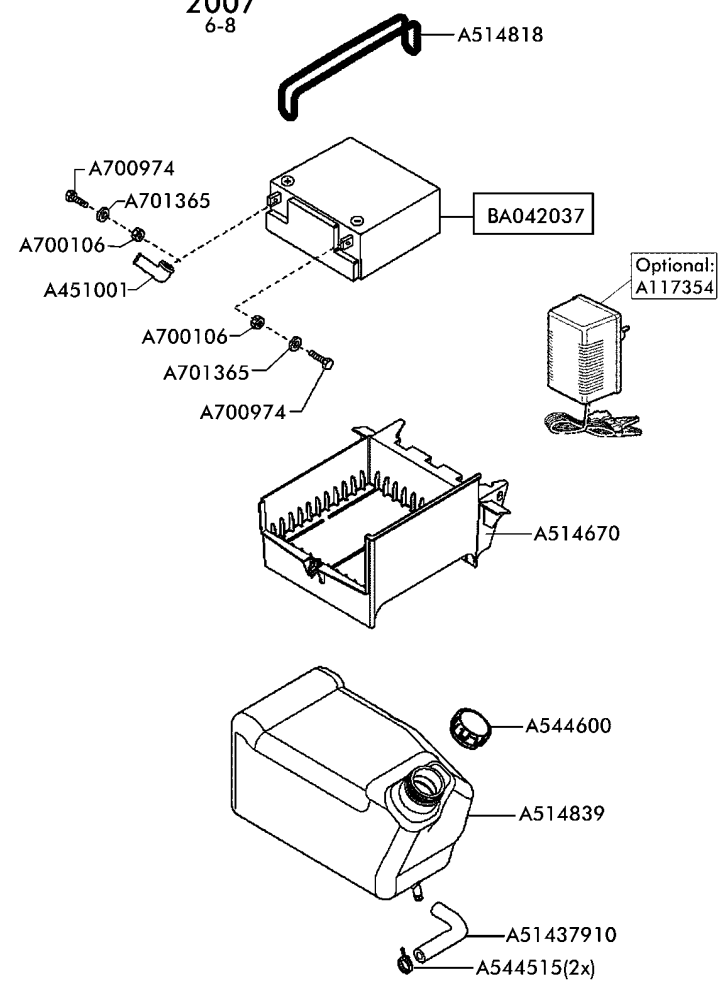

TANK, BATTERIE & KOMPONENTEN
 TANK, BATTERY & COMPONENTS
 TANK, BATTERIE & COMPOSANTS



Technische Änderungen vorbehalten

17/22		RASENTRAKTOREN		Crossover		1/2	
2007		LAWN TRACTORS		102 / 16 Hydro OHV - Art. 65060		1/2	
Rev073804		Tracteurs de pelouse		Modell 2007		1/2	
Bild Nr. REF.N° POS.N°	BEST.-NR. PART.-N° N° d. PIECE	BEZEICHNUNG	DESCRIPTION	DÉSIGNATION	Qty.		
1	A117354	LADEGERÄT Crossover 12 V (optional)	CHARGER Crossover 12 V (optional)	CHARGEUR Crossover 12 V (optional)	1		
2	A321126	MUTTER KASTEN- M 6-ST GALVZ+PASSI	NUT	ECROU	4		
3	A451001	BATTERIEPOLABDECKUNG	POL COVER	COUVERCLE DE PROTECTION	1		
4	A461528	GASFERNBEDIENUNG GCV 530	ACCELERATOR GCV 530	ACCELERATEUR GCV 530	1		
5	A51400930	LENKUNGSRITZEL VERZ.	STEERING WHEEL	PIGNON	1		
6	A514032	LENKSÄULE VERZ	STEERING COLUMN	TUBE DE DIRECTION	1		
7	A514049	STÜTZHOLM	SUPPORT	SUPPORT	1		
8	A514085	STÜTZBLECH	SUPPORT	SUPPORT	1		
9	A514197	EP-BUNDBUCHSE	BUSH	DOILLE	2		
10	A514319	FÜLLSTANDSUMMER	BUZZER (GRASS BAG FULL)	BUZZER	1		
11	A514328	KIPPSCHALTER LICHT	ROCKER SWITCH I/O	INERRUPTEUR À BASCULE	1		
12	A514335	BEFESTIGUNGS MUTTER ZÜNDSCHLOSS	LOCK NUT	EMBOUT	1		
13	A514336	VERDREHSICHERUNG ZÜNDSCHLOSS	SAFETY NUT	EMBOUT	1		
14	A51437910	BENZINSCHLAUCH ZUSCHNITT	CONNECTING TUBE	TUBE DE CONNEXION	1		
15	A514395	BEDIENHEBEL	LEVER	LEVIER	1		
16	A514416	EINRASTBLECH	ENGAGE PLATE	PANNEAU ENCLIQUETER	1		
17	A514670	BATTERIEKASTEN	BATTERY INSERT	BATTERIE CAISSE	1		
18	A514818	BEFESTIGUNGSGUMMI	RUBBER BAND	ÉLASTIQUE	1		
19	A514839	BENZINTANK	TANK	RESERVOIR	1		
20	A514889	ZUSATZ MASSEKABEL	GROUND CABLE	CABLE	1		
21	A521115	SCHNELLBEFESTIGER20SXN26	CROWN FASTENER	FIXATEUR A COURONNE	1		
22	A525315	ZÜNDANLASSCHALTER RIDER	IGNITION SWITCH	INTERRUPTEUR DEMARR. /1	1		
23	A525316	ZÜNDSCHLÜSSEL	STARTING KEY	CLEF A DEMARRAGE	2		
24	A544515	SCHLAUCHKLEMME 14,5	TUBE CLAMP	BORNE	2		
25	A544600	TANKDECKEL KPL	TANK CAP	BOUCHON DE RÉSERVOIR	1		
26	A700106	MUTTER 5 934- 8 VZ	NUT	ECROU	2		
27	A700119	MUTTER 6KT 5 985- 8 VZ	NUT	ECROU	2		
28	A700148	SCHEIBE 6,4 9021-ST VZ	WASHER	RONDELLE	6		
29	A700200	SCHEIBE FÄCHER- J 6,4 6798 VZ	WASHER	RONDELLE	1		
30	A700553	SCHRAUBE 6X 40 933- 8.8VZ	SCREW	VIS	6		
31	A700555	SCHRAUBE 6X 16 933- 8.8VZ	SCREW	VIS	1		
32	A700719	SCHEIBE 21 433 VZ	WASHER	RONDELLE	1		
33	A700961	SCHRAUBE 4X 8 7985- 4.8-H VZ	SCREW	VIS	1		
34	A700974	SCHRAUBE 5X 16 933- 8.8VZ	SCREW	VIS	2		
35	A701296	SICHERUNGSRING 25X1,2 471	CIRCLIP	CIRCLIPS	1		
36	A701352	MUTTER 6KT 4 985- 8 VZ	NUT	ECROU	1		
37	A701365	SCHEIBE FÄCHER- A 5,3 6798 VZ	WASHER	RONDELLE	2		

18/22	RASENTRAKTOREN	 TANK, BATTERIE & KOMPONENTEN TANK, BATTERY & COMPONENTS TANK, BATTERIE & COMPOSANTS	Crossover			
2007	LAWN TRACTORS		102 / 16 Hydro OHV - Art. 65060			2/2
Rev073804	Tracteurs de pelouse		Modell 2007			
Bild Nr. REF.N° POS.N°	BEST.-NR. PART-N° N° d. PIECE	BEZEICHNUNG	DESCRIPTION	DÉSIGNATION	Qty.	
38	A701489	SCHRAUBE 6X 35 933- 8.8VZ	SCREW	VIS	2	
39	A701765	SCHEIBE FÄCHER- A 8,4 6798 VZ	WASHER FÄCHER- A 8,4 6798 VZ	RONDELLE FÄCHER- A 8,4 6798 VZ	4	
40	A702724	SCHEIBE SICH 15 6799 VZ	WASHER	RONDELLE	1	
41	A702830	SCHRAUBE 5X 12 7985- 4.8-H A3R	SCREW	VIS	2	
42	A703191	SCHRAUBE 8X 40 7991- 8.8A3C	SCREW	VIS	4	
43	A704275	SPANNSTIFT 6X24 7344	PIN	GOUPILLE	1	
44	A704536	MUTTER 6KT 6 985- 8 A3B	NUT	ECROU	8	
45	A704537	MUTTER 6KT 8 985- 8 A3B	NUT	ECROU	4	
46	BA042037	BATTERIE 12V-17Ah	BATTERY 12 V-17Ah	BATTERIE 12V-17Ah	1	



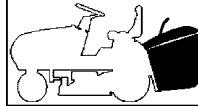

Crossover
102/16 Hydro OHV
Art. 65060

2007
7-8

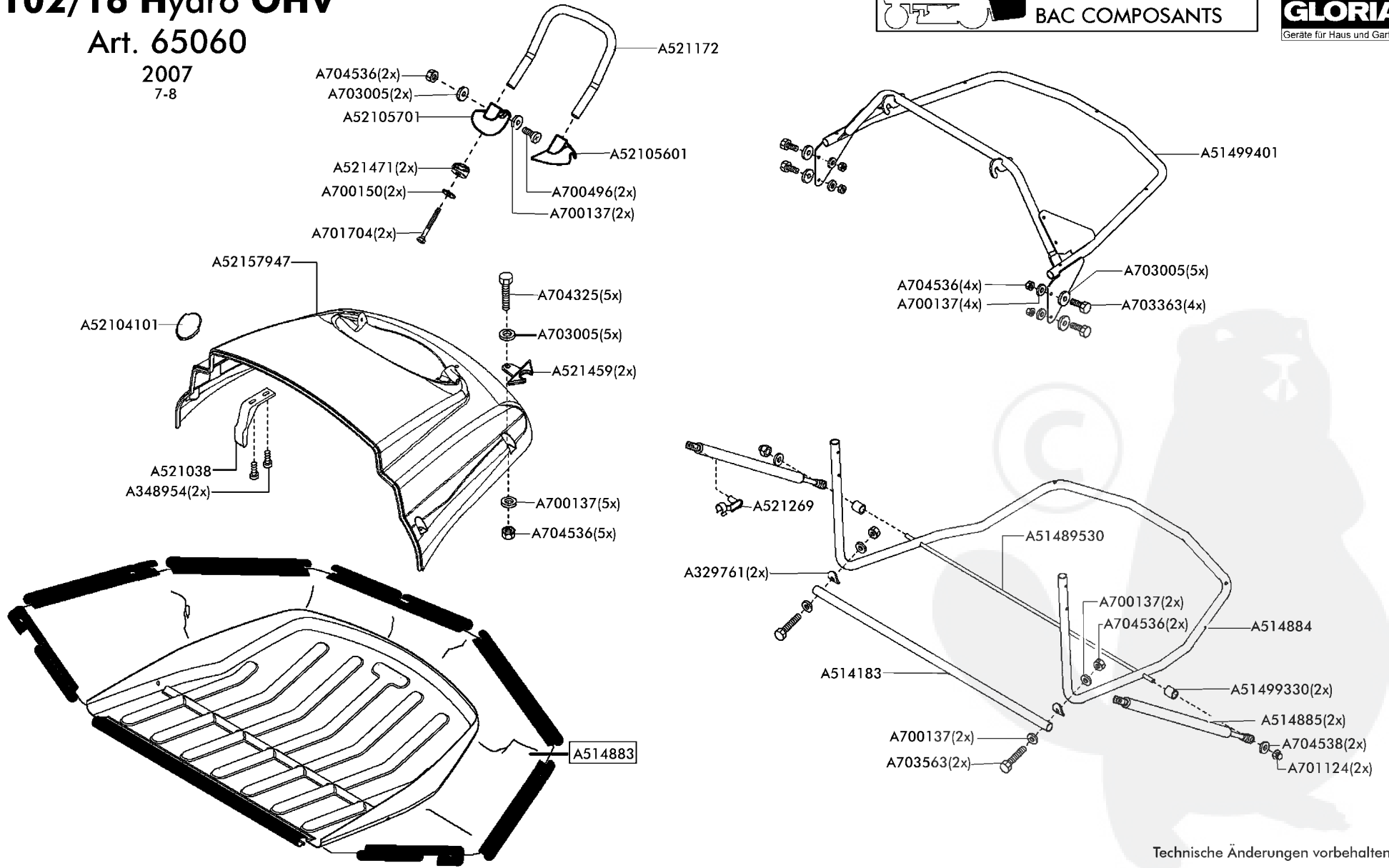
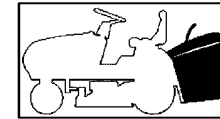

Technische Änderungen vorbehalten

20/22	RASENTRAKTOREN		GRASFANGSACK KPL.	Crossover		
2007	LAWN TRACTORS		GRASS CATCHER ASSY.	102 / 16 Hydro OHV - Art. 65060		
Rev073804	Tracteurs de pelouse		BAC COMPOSANTS	Modell 2007		
Bild Nr. REF.N° POS.N°	BEST.-NR. PART-N° N° d. PIECE	BEZEICHNUNG	DESCRIPTION	DÉSIGNATION	Qty.	
1	A329761	SCHEIBE GEBOGEN H11	CURVED WASHER H11	RONDELLE COURBE	2	
2	A348954	SCHRAUBE.PT-KB 60X25 1411 VZ	SCREW	VIS	2	
3	A514183	QUERSTREBE BOX	ROD	TIGE	1	
4	A514883	GEWEBESACK 102 KPL	GRASS CATCHER BAG ASSY 102	BAC	1	
5	A514884	BOXROHR UNTEN 102	LOWER FRAME ASSY	CHASSIS INFÉRIEUR	1	
6	A514885	GASFEDER GF8-053550-130	GAS PRESSURE SPRING GF8-053550-130	RESSORT PNEUMATIQUE GF8-053550-130	2	
7	A51489530	BOXSTREBE TRAKTOR 102 VERZ	BOX BAR	BAC HAUBAN	1	
8	A51499330	DISTANZHÜLSE BOX VERZ	DISTANCE SLEEVE	CALE DE DISTANCE	2	
9	A51499401	BOXROHR 102 GESCHW R9005	BOX TUBE	BAC TUYAU	1	
10	A521038	KONTAKTWINKEL	BRACKET	EQUERRE-SUPPORT	1	
11	A52104101	VERSCHLUSSTOPFEN R9005	CAP	BOUCHON	1	
12	A52105601	AUFSATZ LINKS R9005	ADAPTER LEFT	ADAPTER GAUCHE	1	
13	A52105701	AUFSATZ RECHTS R9005	ADAPTER RIGHT	ADAPTER DROITE	1	
14	A521172	BOXGRIFF + ROHREINS.M8 KP	HANDLE	POINGEE	1	
15	A521269	FEDERKLAPPBOLZEN FKB 6X12	SPRING SNAP BOLT	BOULON BLOQUER	1	
16	A521459	CLIP FÜR GASDÄMPFERBEFESTIGUNG	CLIP	CLIP	2	
17	A521471	UNTERLAGSCHEIBE FÜR GRIFF	WASHER	RONDELLE	2	
18	A52157947	BOXDECKEL TR 2X BOHREN	BAG COVER	COUVRE-BAC VERT	1	
19	A700137	SCHEIBE A 6,4 125-ST VZ	WASHER	RONDELLE	15	
20	A700150	SCHEIBE 8,4 9021-ST VZ	WASHER	RONDELLE	2	
21	A700496	SCHRAUBE 6X 20 912- 8.8	SCREW	VIS	2	
22	A701124	MUTTER HUT 8 986- 8 VZ	NUT	ECROU	2	
23	A701704	SCHRAUBE 8X 60 933- 8.8VZ	SCREW	VIS	2	
24	A703005	SCHEIBE 6,4 9021-ST A3S	WASHER	RONDELLE	12	
25	A703363	SCHRAUBE 6X 35 933- 8.8A3S	SCREW	VIS	4	
26	A703563	SCHRAUBE 6X 45 933- 8.8A3C	SCREW	VIS	2	
27	A704325	SCHRAUBE 6X 40 933- 8.8A3S	SCREW	VIS	5	
28	A704536	MUTTER 6KT 6 985- 8 A3B	NUT	ECROU	13	
29	A704538	SCHEIBE A 8,4 125-ST A3B	WASHER	RONDELLE	2	

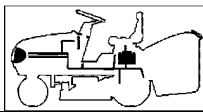

Crossover
102/16 Hydro OHV
 Art. 65060

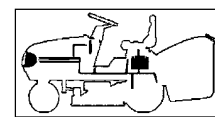

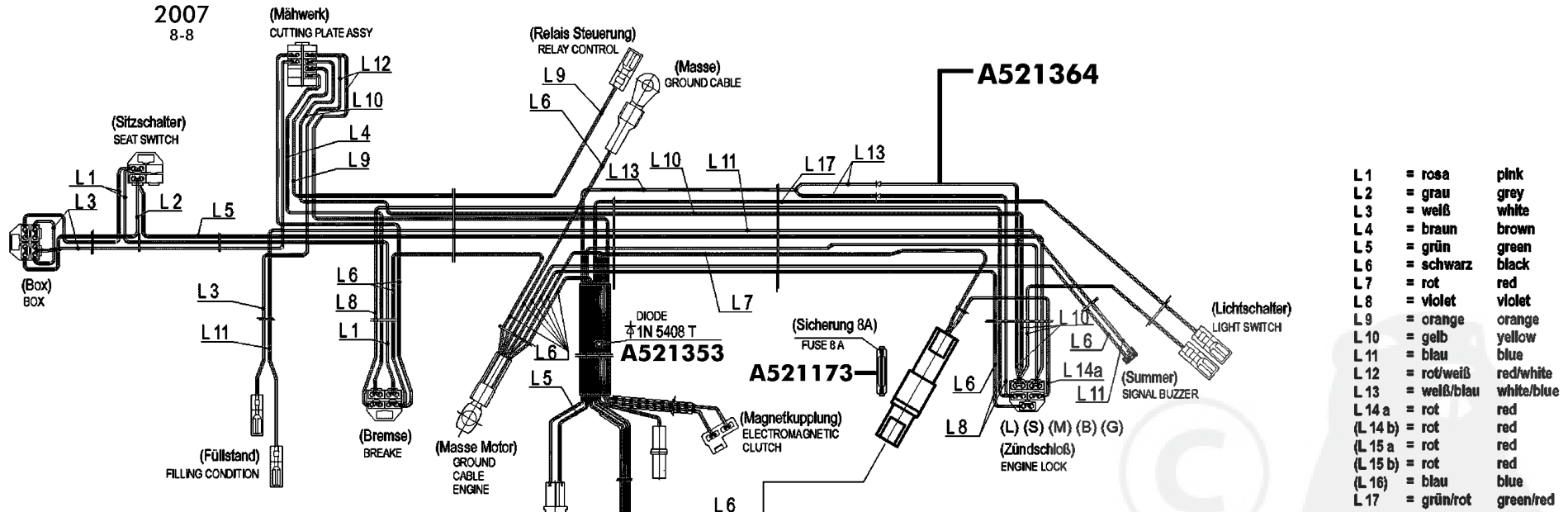

2007
 8-8

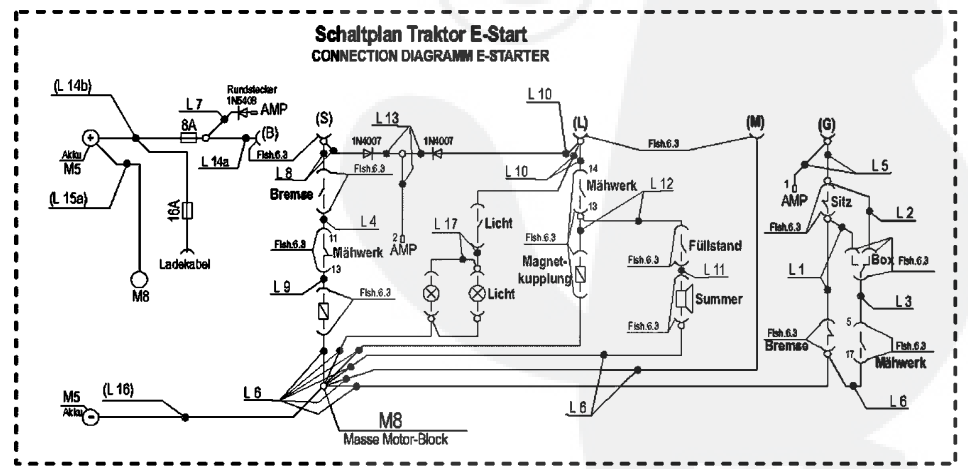
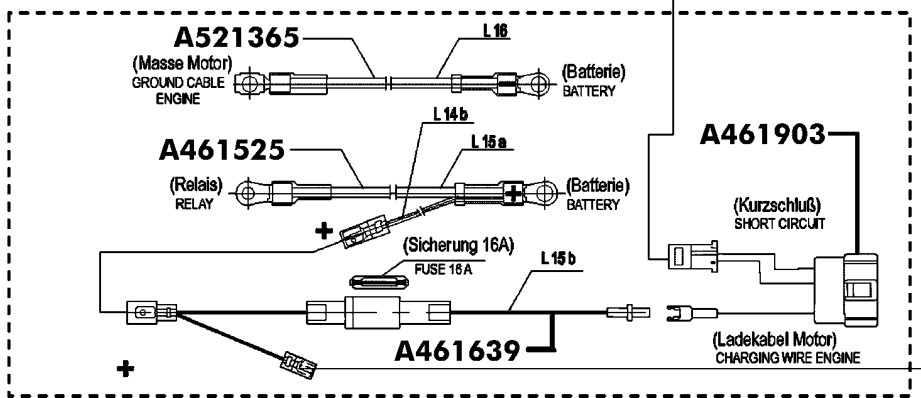

L 1	= rosa	pink
L 2	= grau	grey
L 3	= weiß	white
L 4	= braun	brown
L 5	= grün	green
L 6	= schwarz	black
L 7	= rot	red
L 8	= violett	violet
L 9	= orange	orange
L 10	= gelb	yellow
L 11	= blau	blue
L 12	= rot/weiß	red/white
L 13	= weiß/blau	white/blue
L 14 a	= rot	red
(L 14 b)	= rot	red
(L 15 a)	= rot	red
(L 15 b)	= rot	red
(L 16)	= blau	blue
L 17	= grün/rot	green/red

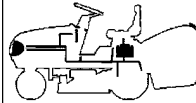

Technische Änderungen vorbehalten

22/22	RASENTRAKTOREN		ELEKTRIK 1 ELECTRIC 1 ELECTRIQUES 1	Crossover		  <small>Copyright for Photo and Caption</small>
2007	LAWN TRACTORS			102 / 16 Hydro OHV - Art. 65060		
Rev073804	Tracteurs de pelouse			Modell 2007		
Bild Nr. REF.N° POS.N°	BEST.-NR. PART-N° N° d. PIECE	BEZEICHNUNG	DESCRIPTION	DÉSIGNATION	Qty.	
1	A461525	KABEL BATTERIE/RELAIS GCV530	CABLE RED BATTERY * RELAIS GCV530	CABLE ROUGE (BATTERIE-RALAIS) GCV530	1	
2	A461639	LADEKABEL 16A GCV 530	CHARGING CABLE GCV 530	CABLE CHARGEUR GCV 530	1	
3	A461903	ADAPTER HONDA GCV 530	ADAPTER HONDA GCV 531	ADAPTER HONDA GCV 532	1	
4	A521173	SICHERUNG 8A	FUSE 8A	FUSIBLE 8A	1	
5	A521353	DIODE 5A IN5408 T ET	DIODE 5A	DIODE 5A	1	
6	A521364	KABELBAUM E-START 102	CABLES ASSY. E-START 102	ENS. CABLAGES E-START 102	1	
7	A521365	KABEL BLAU MASSELEITER	CABLE BLUE (GROUNG CABLE)	CABLE BLEU	1	

