

RASENTRAKTOREN
LAWN TRACTORS
Tracteurs de pelouse

Inhaltsverzeichnis
Table of contents
Tables de matières





Modelle 2007

Crossover

92 / 13

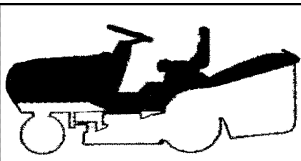
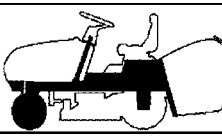
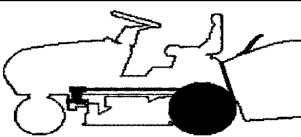
Art. 65055

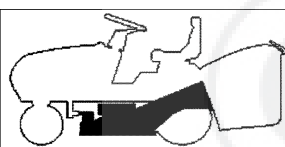
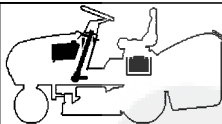
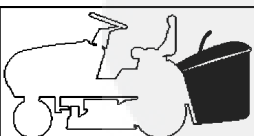
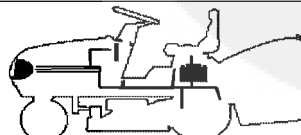
| | | |
|---|---|---|
| 1 |  | KARROSSERIE BODY CARROSSERIE |
| 2 |  | RAHMENSATZ & LENKGETRIEBE CHASSIS & STEERING CHASSIS & BARRE DE DIRECTION |
| 3 |  | GETRIEBE TRANSMISSION TRANSMISSION |
| 4 |  | MOTOR ENGINE MOTEUR |
| 5 |  | SCHNEIDWERK CUTTING PLATE PLATEAU DE COUPE |
| 6 |  | TANK, BATTERIE & KOMPONENTEN TANK, BATTERY & COMPONENTS TANK, BATTERIE & COMPOSANTS |
| 7 |  | GRASFANGSACK KPL. GRASS CATCHER ASSY. BAC COMPOSANTS |
| 8 |  | ELEKTRIK 1 ELECTRIC 1 ELECTRIQUES 1 |

Crossover
92 / 13
Art. 65055
 2007
 1-8

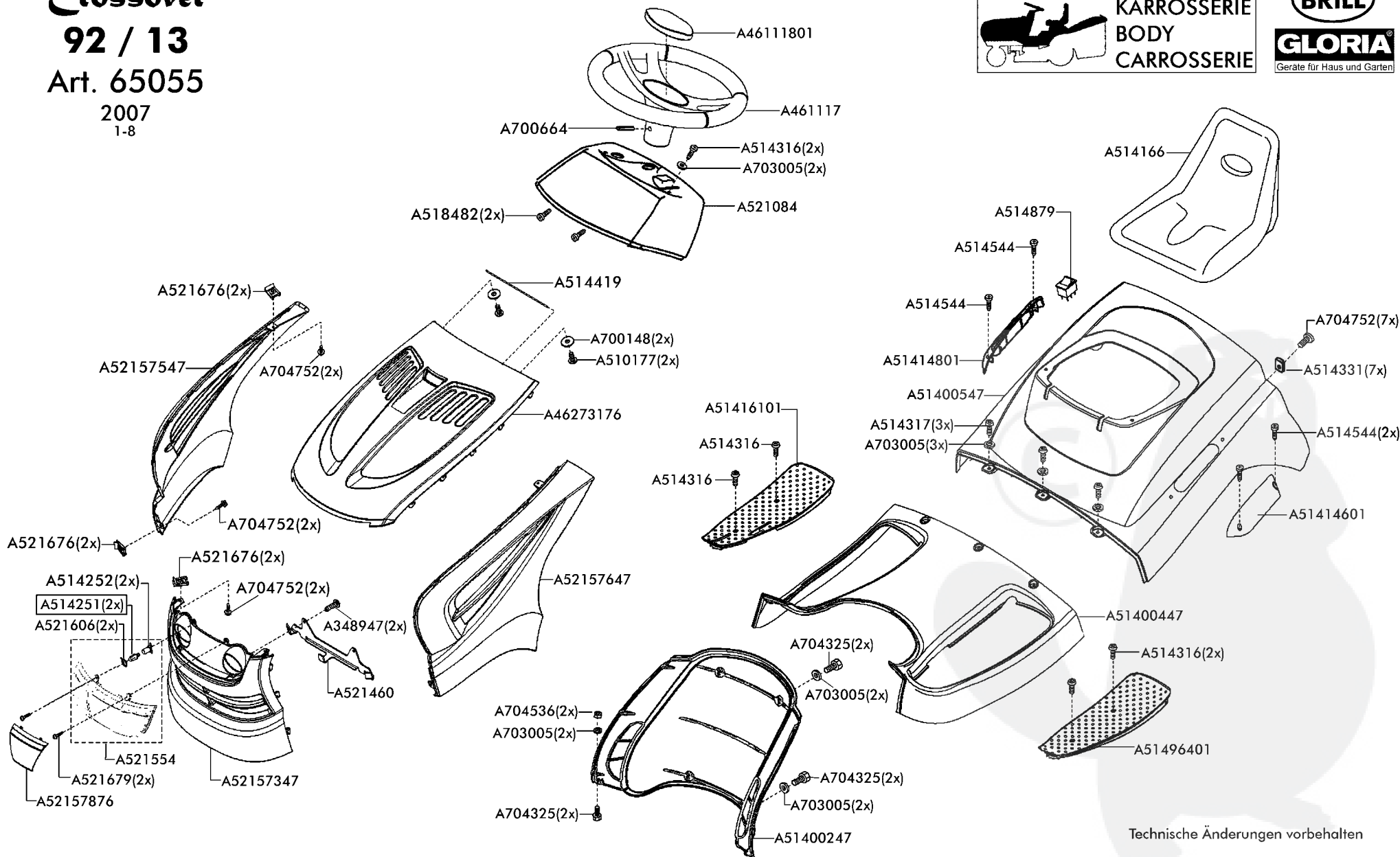

Technische Änderungen vorbehalten

| 2/22 | | RASENTRAKTOREN | | Crossover | |
|------------------------------|--------------------------------------|-----------------------------------|-----------------------------|-------------------------------|------|
| 2007 | | LAWN TRACTORS | | 92 / 13 - Art. 65055 | |
| Rev07380101 | | Tracteurs de pelouse | | Modell 2007 | |
| Bild Nr. REF.N° POS.N° | BEST.-NR. PART.-N° N° d. PIECE | BEZEICHNUNG | DESCRIPTION | DÉSIGNATION | Qty. |
| 1 | A348947 | SCHRAUBE PT-KB 60X20 1442 | SCREW | ECROU | 2 |
| 2 | A461117 | LENKRAD KPL | STEERING WHEEL | VOLANT | 1 |
| 3 | A46111801 | ABDECKKAPPE FÜR LENKRAD R9005 | STEERING CAP | BOUCHON | 1 |
| 4 | A51400447 | ABDECKUNG, UNTEN | LOWER COVER PLATE | COUVRE | 1 |
| 5 | A51416101 | TRITTPLATTE RECHTS R9005 | RIGHT FOOTBOARD | COUVRE MARCHEPIED DROITE | 1 |
| 6 | A51414601 | ABDECKUNG SCHALTGETRIEBE R9005 | BEZEL R9005 | BANDEAU R9005 | 1 |
| 7 | A46273176 | OBERTEIL HAUBE OEM-BRILL R7016 | UPPER HOOD R7016 | CAPOT R7016 | 1 |
| 8 | A510177 | SHR PT-KB 60 X14 1411 | SCREW KB 60 X14 1411 | VIS KB 60 X14 1411 | 2 |
| 9 | A51400247 | KONSOLE MOTORHAUBE R6001 | CENTRAL DASHBOARD | SUPPORT TABLEAU CENTR. | 1 |
| 10 | A51400547 | MITTELKONSOLE HINTEN R6001 | REAR COVER | COUVRE | 1 |
| 11 | A51414801 | ABDECKUNG HÖHENVERSTELLUNG R9005 | BEZEL R9005 | BANDEAU R9005 | 1 |
| 12 | A514166 | SITZ 1 | SEAT | SIÈGE | 1 |
| 13 | A514251 | LAMPE XENON 6W | FARILAMP XENON 6W | LAMPE XENON 6W | 2 |
| 14 | A514252 | LAMPENFASSUNG TRAKTOR | LAMP HOLDER | DOUILLE DE LAMPE | 2 |
| 16 | A514316 | SCHRAUBE SFS-TAPT 6X12 2019 A3R | SCREW | VIS | 6 |
| 17 | A514317 | SCHRAUBE SFS.TAPT6X16 2019 A3R | SCREW | ECROU | 3 |
| 18 | A514331 | BLECHMUTTER 4.8 FORM 1 VZ | NUT | ECROU | 7 |
| 19 | A514419 | FEDERSTAHL DRAHT VERZ | ROD | BARRE | 1 |
| 20 | A514544 | SCHRAUBE PT-KB60X30 1411A3R | SCREW | ECROU | 4 |
| 21 | A514879 | SCHALTER JXA2Z00B-AZC00-000-XA | SWITCH | BOUTON | 1 |
| 22 | A51496401 | TRITTPLATTE LINKS 102 R9005 | LEFT FOOTBOARD | COUVRE MARCHEPIED GAU. | 1 |
| 23 | A521084 | BEDIENKONSOLE TAMP Y-SILBER | DASHBOARD TAMP Y-SILBER | TABLEAU DE BORD TAMP Y-SILBER | 1 |
| 24 | A521460 | SCHARNIERBLECH HAUBE | HOOD SUPPORT | CAPOT SUPPORT | 1 |
| 25 | A521554 | SCHEINWERFER KPL HAUBE-4 XENON 6W | FLOOD LIGHT CARTRIDGE ASSY. | PHARE GARNITURE CPL. | 1 |
| 26 | A52157347 | FRONTTEIL HAUBE R6001 | FRONT HOOD GREEN | CAPOT VERT | 1 |
| 27 | A52157547 | SEITENTEIL RECHTS HAUBE R6001 | SIDE HOOD RIGHT | CAPOT DROITE | 1 |
| 28 | A52157647 | SEITENTEIL LINKS HAUBE R6001 | SIDE HOOD LEFT | CAPOT GAUCHE | 1 |
| 29 | A52157876 | FRONTBLLENDE | COVER PLATE | GRILL | 1 |
| 30 | A521606 | SCHLAUCHKLEMME "REFLEKTOR" | FAIR LED | FIXATION | 2 |
| 31 | A521676 | SCHNAPPMUTTER NU 0921 | NUT NU 0921 | ECROU NU 0921 | 6 |
| 32 | A521679 | SCHRAUBE PT-KB 30X12 WN 5452 | SCREW | VIS | 2 |
| 33 | A700148 | SCHEIBE 6,4 9021-ST VZ | WASHER | RONDELLE | 1 |
| 34 | A700664 | SPANNHUELSE 8 X 60 1481 | COLLET | DOUILLE | 1 |
| 35 | A703005 | SCHEIBE 6,4 9021-ST A3S | WASHER | RONDELLE | 11 |
| 36 | A704325 | SCHRAUBE 6X 40 933- 8.8A3S | SCREW | VIS | 6 |
| 37 | A704536 | MUTTER 6KT 6 985- 8 A3B | NUT | ECROU | 2 |
| 38 | A704752 | SCHRAUBE KO 4,8X16 ZZ-C7981VZ | SCREW | ECROU | 13 |

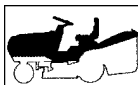



KARROSSERIE
BODY
CARROSSERIE

BRILL

GLORIA
Garden for Home and Garden

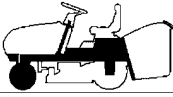

| 4/22 | | RASENTRAKTOREN | |  RAHMENSATZ & LENKGETRIEBE CHASSIS & STEERING CHASSIS & BARRE DE DIRECTION | | Crossover | | 92 / 13 - Art. 65055 | | 1/3  | |
|------------------------------|--------------------------------------|---|-------------------------|--|------|-------------|--|----------------------|--|---|--|
| 2007 | | LAWN TRACTORS | | | | Modell 2007 | | | |  | |
| Rev:07380101 | | Tracteurs de pelouse | | | | | | | | | |
| Bild Nr. REF.N° POS.N° | BEST.-NR. PART.-N° N° d. PIECE | BEZEICHNUNG | DESCRIPTION | DÉSIGNATION | Qty. | | | | | | |
| 1 | A2042850001 | DRUCKKNOPF F. BR-HEBEL T | BUTTON | POUSSOIR | 1 | | | | | | |
| 2 | A2045480006 | FEDER F. HANDGRIFF T | SPRING | RESSORT | 1 | | | | | | |
| 3 | A302231 | KAPPE R9005 | CAP | BONNET | 1 | | | | | | |
| 4 | A348988 | MUTTER SICH- BIW M 8 A3C- 8 MITTELGESICHT | NUT | ECROU | 1 | | | | | | |
| 5 | A375725 | HANDGRIFF HOENENVERST. T | KNOB | POIGNEE | 1 | | | | | | |
| 6 | A450263 | BUCHSE TRAKTOR VORDERRAD | BUSH | DOUILLE | 2 | | | | | | |
| 7 | A46110530 | LENKSEGMENT GESCHW VERZ | SEGMENT | SEGMENT GUIDER | 1 | | | | | | |
| 8 | A46110730 | LENKHEBEL 2 TEILIG UNTEN VERZ | LOWER STEERING ARM | LEVIER GUIDER EN BAS | 1 | | | | | | |
| 9 | A46110830 | LENKHEBEL 2 TEILIG OBEN VERZ | UPPER STEERING ARM | LEVIER GUIDER EN HAUT | 1 | | | | | | |
| 10 | A461109 | BUNDBUCHSE LENKUNG | COLLAR BUSH | DOUILLE | 1 | | | | | | |
| 11 | A461110 | BUCHSE | BUSH | DOILLE | 1 | | | | | | |
| 12 | A46111130 | SCHUBSTANGE VERZ | STEERING ROD DIRECTION | LEVIER BARRE DE | 1 | | | | | | |
| 13 | A461231 | MUTTER SICH- BIW M10 A3B- 8 | NUT | ECROU | 2 | | | | | | |
| 14 | A461289 | ABDECKKAPPE"TRAKTOR" | HUB COVER | COUVRE MOYEU | 2 | | | | | | |
| 15 | A461290 | SCHEIBE 42MM FÜR TRAKTOR | WASHER | RONDELLE | 2 | | | | | | |
| 16 | A461497 | WIPPE FÜR KUPPLUNG FAHRANTRIEB | ROCKER | BASCULE | 1 | | | | | | |
| 17 | A461498 | ZUGSTANGE FÜR KUPPLUNG FAHRANTRIEB | TENSION ROD | BARRE | 1 | | | | | | |
| 18 | A461499 | ROHR FÜR KUPPLUNG FAHRANTRIEB | TUBE FOR CLUTCH (DRIVE) | TUYAU EMBRAYAGE ENTR.D.ROUE | 1 | | | | | | |
| 19 | A461500 | ZUGFEDER FÜR KUPPLUNG FAHRANTRIEB | SPRING | RESSORT | 1 | | | | | | |
| 20 | A461501 | LAGERSCHEIBE FÜR KUPPLUNG FAHRANTRIEB | DISK | DISQUE | 2 | | | | | | |
| 21 | A461502 | KUGELFÜHRUNG FÜR KUPPLUNG FAHRANTR | GUIDANCE | GUIDAGE | 1 | | | | | | |
| 22 | A461535 | MANTEL FÜR REIFEN 13X6,50-6 2PR | SHOE 13X6,50-6 2PR | PNEU 13X6,50-6 2PR | 2 | | | | | | |
| 23 | A46189340 | STOSSSTANGE 30 MM LANG R9006 BRILL | BUMPER R9006 | PARE-CHOCS | 1 | | | | | | |
| 24 | A510566 | SCHNELLBEFESTIGER 8SXN26 | CROWN FASTENER | FIXATEUR A COURONNE | 3 | | | | | | |
| 25 | A513010 | SCHNELLBEFESTIGER 16 SXN27 | CROWN FASTENER | FIXATEUR A COURONNE | 1 | | | | | | |
| 26 | A51404130 | SPURSTANGE VERZ | STEERING ROD | BARRE DE DIRECTION | 1 | | | | | | |
| 27 | A514042 | BUCHSE-ACHSSCHENKEL | BRASS | COUSSINET | 4 | | | | | | |
| 28 | A51406701 | PEDALAUFLAGE BREMSE UND KUPPL. R9005 | CLAMP COVER FRONT | COUVRE ETRIER AVANT | 1 | | | | | | |
| 29 | A51406830 | PEDAL RECHTS VERZ | DRIVE PEDAL | PEDALE TRANSMISSION | 1 | | | | | | |
| 30 | A514224 | HEBEL KPL.HÖHENVERSTELLUNG | LEVER | LEVIER | 1 | | | | | | |
| 31 | A51424130 | BEFESTIGUNGSBÜGEL SCHALTUNG VERZ | PLATE | PLAQUE | 1 | | | | | | |
| 32 | A514299 | PENDELANSCHLAG VERZ | BLOCK | BLOC | 4 | | | | | | |
| 33 | A514307 | DRUCKFEDER FÜR SITZ | SPRING | RESSORT | 2 | | | | | | |
| 34 | A514316 | SCHRAUBE SFS-TAPT 6X12 2019 A3R | SCREW | VIS | 1 | | | | | | |
| 35 | A514327 | DRUCKSCHALTER | PRESS SWITCH | INTERRUPTEUR À PRESSION | 2 | | | | | | |
| 36 | A514346 | ABDECKKAPPE D-35 RAL9005 | HOOD | PROTECTEUR | 2 | | | | | | |
| 37 | A51436030 | LAGERBUCHSE-VORDERACHSE VERZ | SPACER | ENTRETOISE | 1 | | | | | | |
| 38 | A514385 | SCHALTERHALTER | SUPPORT | SUPPORT | 1 | | | | | | |

| 5/22 | | RASENTRAKTOREN | |  RAHMENSATZ & LENKGETRIEBE CHASSIS & STEERING CHASSIS & BARRE DE DIRECTION | Crossover | | 2/3 |   |
|------------------------------|--------------------------------------|---|-------------------------|--|----------------------|--|-----|--|
| 2007 | | LAWN TRACTORS | | | 92 / 13 - Art. 65055 | | | |
| Rev07380101 | | Tracteurs de pelouse | | | Modell 2007 | | | |
| Bild Nr. REF.N° POS.N° | BEST.-NR. PART.-N° N° d. PIECE | BEZEICHNUNG | DESCRIPTION | DÉSIGNATION | Qty. | | | |
| 39 | A514386 | DREHFEDER RECHTS | SPRING | RESSORT | 1 | | | |
| 40 | A51438730 | DISTANZBUCHSE VERZ | SPACER | BAGUE D'ÉCARTEMENT | 1 | | | |
| 41 | A514396 | BÜGEL | CONNECTING PLATE | PAQUE DE CONNEXION | 1 | | | |
| 42 | A514410 | FESTSTELLFEDER RECHTS | SPRING | RESSORT | 1 | | | |
| 43 | A51442430 | LAGERBOLZEN PEDAL VERZ. | PIN | PIVOT | 1 | | | |
| 44 | A51447701 | PENDELACHSE GESCHW R9005 | FLOATING AXLE | ABRE OSCILLANT | 1 | | | |
| 45 | A514701 | WINKELGELENK CS16-M10+SIC | JOINT | JOINT | 4 | | | |
| 46 | A5148240110 | RAHMEN 102CM R9005 NACHARBEIT | CHASSIS 102 R9005 | CHASSIS 102 R9005 | 1 | | | |
| 47 | A51484530 | LAGERWELLE GESCHW VERZ | SHAFT | ARBRE | 1 | | | |
| 48 | A519076 | ROHRSTOPFEN FÜR ROHR 30X2 | COVER | BOUCHER | 2 | | | |
| 49 | A521123 | SCHEIBE D50X5 | WASHER | RONDELLE | 1 | | | |
| 50 | A521170 | ACHSSCHENKEL LI.VZ.NEU ET | LEFT STUB AXLE | FUSEAU GAUCHE | 1 | | | |
| 51 | A521171 | ACHSSCHENKEL RE.VZ.NEU ET | RIGHT STUB AXLE | FUSEAU DROITE | 1 | | | |
| 52 | A521268 | ROLLENLAGER 20X30X55 | ROLLER BEARING | COUSSINET | 2 | | | |
| 53 | A521361 | STARTERRELAIS 12V/100AMPER | STARTER RELAY | RELAIS D'ALL. | 1 | | | |
| 54 | A521375 | SKT-MUTTER+SPERRZ.1/4"-20 UN 8.8 | NUT | ECROU | 2 | | | |
| 55 | A521395 | VERSTELLKONSOLE SITZ GENIETET | PLATE | PLAQUE | 1 | | | |
| 56 | A521461 | ANBINDUNGSBLECH RECHTS | STIFFENING RIGHT | RENFORCEMENT DROITE | 1 | | | |
| 57 | A521462 | ANBINDUNGSBLECH LINKS | BRACKET LEFT | RENFORCEMENT GAUCHE | 1 | | | |
| 58 | A521475 | WÄRMELEITBLECH UNTEN H-4 UND 2 ZYLINDER | LOWER HEAT GUARD | DÉFLECTEUR CHALEUR EN BAS | 1 | | | |
| 59 | A521480 | FLÜGELSCHRAUBE M8X20 | SCREW | VIS | 2 | | | |
| 60 | A521727 | DISTANZBUCHSE | SPACER | ENTRETOISE | 2 | | | |
| 61 | A52185240 | VORDERRAD 13X6.5-6 BREIT KPL R9006 | FRONT WHEEL 13X6.5-6 | ROUE AVANT 113X6.5-6 | 2 | | | |
| 62 | A523134 | SFS-TAPT.M6X12 2021 A2K | SCREW | VIS | 1 | | | |
| 63 | A546220 | SCHLAUCH 13"X6.5"-6 TR13 | TUBE | TUYAU | 2 | | | |
| 64 | A625877 | SEGMENT "FE/ZN 12 F" | STEERING SHAFT | ARBRE DIRECTION | 1 | | | |
| 65 | A700051 | SCHRAUBE 8X 20 912- 8.8 VZ | SCREW 8X 20 912- 8.8 VZ | VIS 8X 20 912- 8.8 VZ | 2 | | | |
| 66 | A700148 | SCHEIBE 6,4 9021-ST VZ | WASHER | RONDELLE | 5 | | | |
| 67 | A700150 | SCHEIBE 8,4 9021-ST VZ | WASHER | RONDELLE | 4 | | | |
| 68 | A700200 | SCHEIBE FÄCHER- J 6,4 6798 VZ | WASHER | RONDELLE | 2 | | | |
| 69 | A700203 | NIPPEL AS 6X1 KEG 71412 | GREASE DISPENSER | GRAISSEUR | 2 | | | |
| 70 | A700545 | SCHRAUBE 8X 16 933- 8.8VZ | SCREW 8X 16 933- 8.8VZ | VIS 8X 16 933- 8.8VZ | 4 | | | |
| 71 | A700555 | SCHRAUBE 6X 16 933- 8.8VZ | SCREW | VIS | 1 | | | |
| 72 | A700719 | SCHEIBE 21 433 VZ | WASHER | RONDELLE | 1 | | | |
| 73 | A701011 | SCHRAUBE 8X 50 933- 8.8VZ | SCREW | VIS | 4 | | | |
| 74 | A701083 | SCHEIBE 8,4VZ7349"701083" | WASHER | RONDELLE | 1 | | | |
| 75 | A701166 | SCHEIBE PA 20X28X0,5 988 | WASHER | RONDELLE | 1 | | | |
| 76 | A701395 | BLINDNIET 4,0X 8 | RIVET | RIVET | 2 | | | |

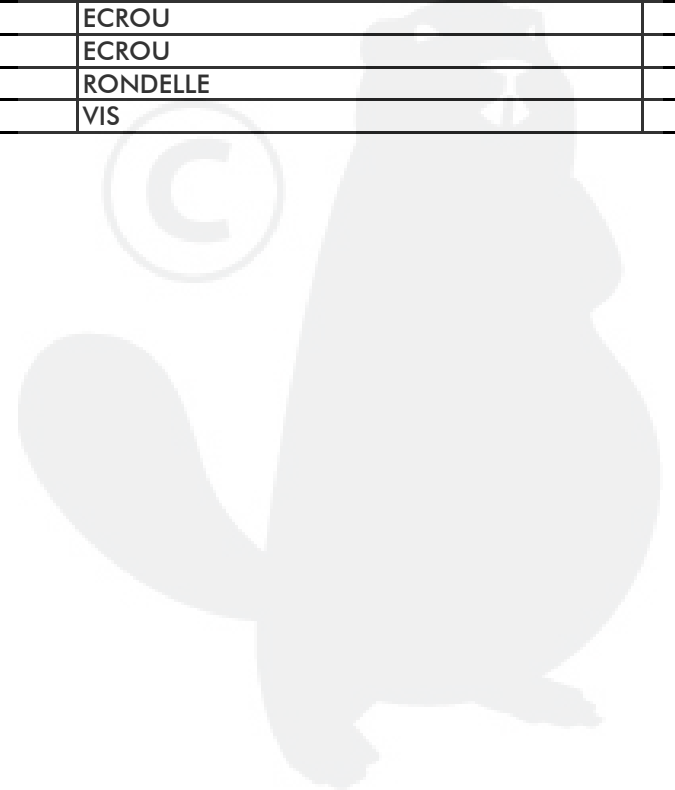
| 6/22 | | RASENTRAKTOREN | |  RAHMENSATZ & LENKGETRIEBE CHASSIS & STEERING CHASSIS & BARRE DE DIRECTION | | Crossover | | 92 / 13 - Art. 65055 | | 3/3 | |   | | | |
|------------------------------|-------------------------------------|-------------------------------|--|--|--|------------------------|--|----------------------|--|-----|--|--|--|--|--|
| 2007 | | LAWN TRACTORS | | | | Crossover | | Modell 2007 | | | | | | | |
| Rev07380101 | | Tracteurs de pelouse | | | | | | | | | | | | | |
| Bild Nr. REF.N° POS.N° | BEST.-NR. PART-N° N° d. PIECE | BEZEICHNUNG | | DESCRIPTION | | DÉSIGNATION | | Qty. | | | | | | | |
| 77 | A701478 | MUTTER HUT 5 986- 8 VZ | | NUT | | ECROU | | 1 | | | | | | | |
| 78 | A701765 | SCHEIBE FÄCHER- A 8,4 6798 VZ | | WASHER FÄCHER- A 8,4 6798 VZ | | RONDELLE A 8,4 6798 VZ | | 4 | | | | | | | |
| 79 | A701985 | SCHRAUBE 8X 55 931- 8.8VZ | | SCREW | | VIS | | 1 | | | | | | | |
| 80 | A702381 | SCHRAUBE 8X 30 7991- 8.8 VZ | | SCREW | | VIS | | 1 | | | | | | | |
| 81 | A702574 | SCHEIBE PA 14X20X1,0 988 VZ | | WASHER | | RONDELLE | | 1 | | | | | | | |
| 82 | A702724 | SCHEIBE SICH 15 6799 VZ | | WASHER | | RONDELLE | | 3 | | | | | | | |
| 83 | A702812 | SHR10X 55 931- 8.8A3C | | SCREW | | VIS | | 1 | | | | | | | |
| 84 | A702893 | SCHEIBE SICH 10 6799 DAC | | WASHER | | RONDELLE | | 1 | | | | | | | |
| 85 | A703005 | SCHEIBE 6,4 9021-ST A3S | | WASHER | | RONDELLE | | 1 | | | | | | | |
| 86 | A703813 | MUTTER 6KT 10 985-10 A3B | | NUT | | ECROU | | 3 | | | | | | | |
| 87 | A703974 | SCHRAUBE 5X 20 965-4.8-H A3B | | SCREW | | VIS | | 1 | | | | | | | |
| 88 | A704138 | SCHRAUBE 6X 16 603- 4.6A3B | | SCREW | | ECROU | | 4 | | | | | | | |
| 89 | A704368 | SCHRAUBE 6X 18 933- 8.8A3C | | SCREW | | ECROU | | 2 | | | | | | | |
| 90 | A704534 | MUTTER 10 934- 8 A3B | | NUT | | ECROU | | 4 | | | | | | | |
| 91 | A704536 | MUTTER 6KT 6 985- 8 A3B | | NUT | | ECROU | | 8 | | | | | | | |
| 92 | A704537 | MUTTER 6KT 8 985- 8 A3B | | NUT | | ECROU | | 12 | | | | | | | |
| 93 | A704540 | SCHEIBE A 13 125-ST A3B | | WASHER | | RONDELLE | | 1 | | | | | | | |
| 94 | A704546 | SCHRAUBE 8X 20 933- 8.8A3B | | SCREW | | VIS | | 2 | | | | | | | |

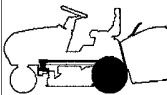

| 8/22 | | RASENTRAKTOREN | |  GETRIEBE TRANSMISSION TRANSMISSION | Crossover | | 1/2   |
|------------------------------|--------------------------------------|--|--------------------------------|---|----------------------|--|--|
| 2007 | | LAWN TRACTORS | | | 92 / 13 - Art. 65055 | | |
| Rev07380101 | | Tracteurs de pelouse | | | Modell 2007 | | |
| Bild Nr. REF.N° POS.N° | BEST.-NR. PART.-N° N° d. PIECE | BEZEICHNUNG | DESCRIPTION | DÉSIGNATION | Qty. | | |
| 1 | A317280 | KABELSCHELLE | CABLE CLIP | COLLIER | 2 | | |
| 2 | A321126 | MUTTER KASTEN- M 6-ST GALVZ+PASSI | NUT M 6-ST GALVZ+PASSI | ECROU M 6-ST GALVZ+PASSI | 2 | | |
| 3 | A46128730 | BOXVERRIEGELUNG GESCHW VERZ | BOX LOCKING | BOX DISPOSITIF DE BLOCKAGE | 1 | | |
| 4 | A46128830 | VERRIEGELUNGSSTANGE VERZ | LOCKING ROD | BARRE DE BLOCKAGE | 1 | | |
| 5 | A461289 | ABDECKKAPPE"TRAKTOR" | HUB COVER | COUVRE MOYEU | 2 | | |
| 6 | A461290 | SCHEIBE 42MM FÜR TRAKTOR | WASHER | RONDELLE | 2 | | |
| 7 | A461292 | RÜCKHOLFEDER BOXVERRIEGELUNG | TENSION SPRING | RESSORT | 1 | | |
| 8 | A46151301 | RÜCKWAND 102 R9005 | REAR PANEL | PANNEAU ARRIERE | 1 | | |
| 9 | A461536 | MANTEL FÜR REIFEN 18X8,50-8 2PR | SHOE 18X8,50-8 2PR | PNEU 18X8,50-8 2PR | 2 | | |
| 10 | A511249 | SCHNELLBEFESTIGER 7SXN26 | CROWN FASTENER 7SXN26 | FIXATEUR A COURONNE 7SXN26 | 1 | | |
| 11 | A511461 | SCHRTAPT-EJOT8X16 1347A A3B | SCREW | VIS | 1 | | |
| 12 | A511693 | SCHRAUBE PT-KB 5X10 WN1411 A3B | SCREW | VIS | 2 | | |
| 13 | A512997 | SFS-TAPT 8X12 NR2021 A3C | SFS TAPT SCREW 8X12 NR2021 A3C | SFS TAPT VIS 8X12 NR2021 A3C | 1 | | |
| 14 | A514011 | SCHALTGETRIEBE 5-GANG MST 205-540 D | GEARBOX ASSY. MST 205-540 D | TRANSMISSION CPL MST 205-540 D | 1 | | |
| 15 | A514075 | KEILRIEMENSCHLEIBE GETRIEBE 5-GANG KPL | PULLEY ASSY | POULIE | 1 | | |
| 16 | A514081 | Y-STEHLAGER 3/4" | SUPPORT ASSY | SUPPORT CPL | 1 | | |
| 17 | A51413130 | ANSTEUERHEBEL SCHALTGETRIEBE VERZ | LEVER | LEVIER | 1 | | |
| 18 | A514132 | VERBINDUNGSSTANGE-SCHALTGETRIEBE | CONNECTION ROD | BARRE DE CONNECTION | 1 | | |
| 19 | A514157 | SCHALT-BOWDENZUG-BREMSE | BOWDEN CABLE | FIL | 1 | | |
| 20 | A514174 | SCHALTGRIF | KNOB | POIGNEE | 1 | | |
| 21 | A51418130 | WIDERLAGER BREMSE VERZ. | SUPPORT ASSY | SUPPORT CPL | 1 | | |
| 22 | A51423730 | DISTANZBUCHSE VERZ. | SPACER | ENTRETOISE | 1 | | |
| 23 | A514239 | WINKELGELENK C13SXN68/02R | JOINT | JOINT | 2 | | |
| 24 | A51424030 | DISTANZHÜLSE-SCHALTUNG VERZ | SPACER | DOUILLE | 1 | | |
| 25 | A51424130 | BEFESTIGUNGSBÜGEL SCHALTUNG VERZ | PLATE | PLAQUE | 1 | | |
| 26 | A514313 | PASSFEDER 3/16"X3/16"X2 1/4 | FIT-IN KEY | GOUPILLE | 2 | | |
| 27 | A514327 | DRUCKSCHALTER | PRESS SWITCH | INTERRUPTEUR À PRESSION | 1 | | |
| 28 | A514329 | MIKROSCHALTER FÜLLSTANDANZEIGE | SWITCH | INTERRUPTEUR | 1 | | |
| 29 | A514337 | ABDECKTÜLLE FÜR DRUCKSCHALTER | COVER | COUVERCLE PROTECTION | 1 | | |
| 30 | A514446 | GLEITBUCHSE SCHALTUNG | SLIDING BUSHING | DOUILLE GLISSEMENT | 1 | | |
| 31 | A51444830 | GETRIEBESCHALTHEBEL GESCHW VERZ | LEVER | LEVIER | 1 | | |
| 32 | A514605 | RÜCKSTELLFEDER BREMSHEBEL | SPRING PLATE | RESSORT | 1 | | |
| 33 | A514682 | SCHALTHEBEL LANG | LEVER | LEVIER | 1 | | |
| 34 | A51477430 | FEDERBLECH SCHALTUNG VERZ | SPRING PLATE | MACARON RESSORT | 1 | | |
| 35 | A51481901 | VERSTEIFUNGSROHR SG GESCHW R9005 | TUBE | CARNEAU | 1 | | |
| 36 | A51482230 | SCHALTHEBEL VERZ | LEVER | LEVIER | 1 | | |
| 37 | A51486201 | LAGERARM RECHTS UNTEN R9005 | LOWER BEARING ARM RIGHT | PALIER BRAS DROITE EN BAS | 1 | | |
| 38 | A51486301 | LAGERARM RECHTS OBEN R9005 | UPPER BEARING ARM RIGHT | PALIER BRAS DROITE EN HAUT | 1 | | |

| 9/22 | | RASENTRAKTOREN | |  GETRIEBE TRANSMISSION TRANSMISSION | Crossover | | 1/2   |
|------------------------------|--------------------------------------|------------------------------------|-------------------------------|---|----------------------|--|--|
| 2007 | | LAWN TRACTORS | | | 92 / 13 - Art. 65055 | | |
| Rev07380101 | | Tracteurs de pelouse | | | Modell 2007 | | |
| Bild Nr. REF.N° POS.N° | BEST.-NR. PART.-N° N° d. PIECE | BEZEICHNUNG | DESCRIPTION | DÉSIGNATION | Qty. | | |
| 39 | A51486401 | LAGERARM LINKS UNTEN R9005 | LOWER BEARING ARM LEFT | PALIER BRAS GAUCHE EN BAS | 1 | | |
| 40 | A51486701 | LAGERARM LINKS OBEN R9005 | UPPER BEARING ARM LEFT | PALIER BRAS GAUCHE EN HAUT | 1 | | |
| 41 | A514942 | VERRIEGELUNGSKNOPF R9005 | ARRESTOR KNOB | BOUTON DE PRESSION ARRE. | 1 | | |
| 42 | A51866030 | DISTANZHÜLSE-TOTMANN VERZ | SPACER | DOUILLE | 1 | | |
| 43 | A521048 | FAHRANTRIEBSRIEMEN 102 SG | DRIVE BELT 102 SG | COURROIE 102 SG | 1 | | |
| 44 | A521339 | FÜLLSTANDSUMMERGEHÄUSE UND HEBEL | PROTECTION COVER & LEVER CPL | COUVERCLE PROTECTION & LEVIER CPL | 1 | | |
| 45 | A52185340 | HINTERRAD 18X8.5-8 BREIT KPL R9006 | REAR WHEEL CPL 18X8.5-8 | ROUE ARRIERE CPL 18X8.5-8 | 2 | | |
| 46 | A522531 | SCHEIBENFEDER 3/16"X3/4" | LOCK WASHER | DISQUE DE RESSORT | 1 | | |
| 47 | A526521 | SCHNELLBEFESTIGER 3SXN26 | CROWN FASTENER | FIXATEUR A COURONNE | 2 | | |
| 48 | A546222 | SCHLAUCH 18"X8.5"-8 / 9.50-8 TR13 | HOSE 18"X8.5"-8 / 9.50-8 TR13 | TUYAU 18"X8.5"-8 / 9.50-8 TR13 | 2 | | |
| 49 | A700137 | SCHEIBE A 6,4 125-ST VZ | WASHER | RONDELLE | 2 | | |
| 50 | A700148 | SCHEIBE 6,4 9021-ST VZ | WASHER | RONDELLE | 1 | | |
| 51 | A700150 | SCHEIBE 8,4 9021-ST VZ | WASHER | RONDELLE | 13 | | |
| 52 | A700200 | SCHEIBE FÄCHER- J 6,4 6798 VZ | WASHER | RONDELLE | 1 | | |
| 53 | A700246 | RING SICHT 16X1 471 | CIRCLIP | CIRCLIPS | 1 | | |
| 54 | A700656 | FED TEL 28 X10,2X1,25 2093 | DISK SPRING | DISQUE | 1 | | |
| 55 | A700661 | HUEL SPAN 6 X 20 1481 | BUSHING | DOUILLE | 2 | | |
| 56 | A700702 | SCHRAUBE 6X 25 933- 8.8VZ | SCREW | VIS | 2 | | |
| 57 | A700844 | SCHRAUBE 8X 20 603- 4.6VZ | SCREW | VIS | 4 | | |
| 58 | A700967 | SCHRAUBE 8X 35 603- 4.6VZ | SCREW | VIS | 2 | | |
| 59 | A701375 | SCHRAUBE 6X 12 7985- 4.8-H VZ | SCREW 8X 25 933- 8.8A3B | VIS 8X 25 933- 8.8A3B | 2 | | |
| 60 | A701612 | SCHR SKT UNF 1/ 4"X12 | SCREW UNF 1/ 4"X12 | VIS UNF 1/ 4"X12 | 1 | | |
| 61 | A701672 | SCHRAUBE | SCREW | VIS | 1 | | |
| 62 | A701704 | SCHRAUBE 8X 60 933- 8.8VZ | SCREW | VIS | 5 | | |
| 63 | A701765 | SCHEIBE FÄCHER- A 8,4 6798 VZ | WASHER FÄCHER- A 8,4 6798 VZ | RONDELLE A 8,4 6798 VZ | 1 | | |
| 64 | A702724 | SCHEIBE SICHT 15 6799 VZ | WASHER | RONDELLE | 2 | | |
| 65 | A703892 | SCHRAUBE 8X 45 933- 8.8A3B | SCREW | VIS | 7 | | |
| 66 | A704263 | SCHEIBE S 19X26X1,5 988A3C | WASHER | RONDELLE | 4 | | |
| 67 | A704270 | SCHRAUBE 8X25 EN ISO7380-10.9A3C | SCREW | VIS | 1 | | |
| 68 | A704272 | SCHEIBE PA 8X14X1,0 988 | WASHER | RONDELLE | 2 | | |
| 69 | A704533 | MUTTER 8 934- 8 A3B | NUT | ECROU | 2 | | |
| 70 | A704536 | MUTTER 6KT 6 985- 8 A3B | NUT | ECROU | 4 | | |
| 71 | A704537 | MUTTER 6KT 8 985- 8 A3B | NUT | ECROU | 29 | | |
| 72 | A704538 | SCHEIBE A 8,4 125-ST A3B | WASHER | RONDELLE | 1 | | |
| 73 | A704546 | SCHRAUBE 8X 20 933- 8.8A3B | SCREW | VIS | 9 | | |



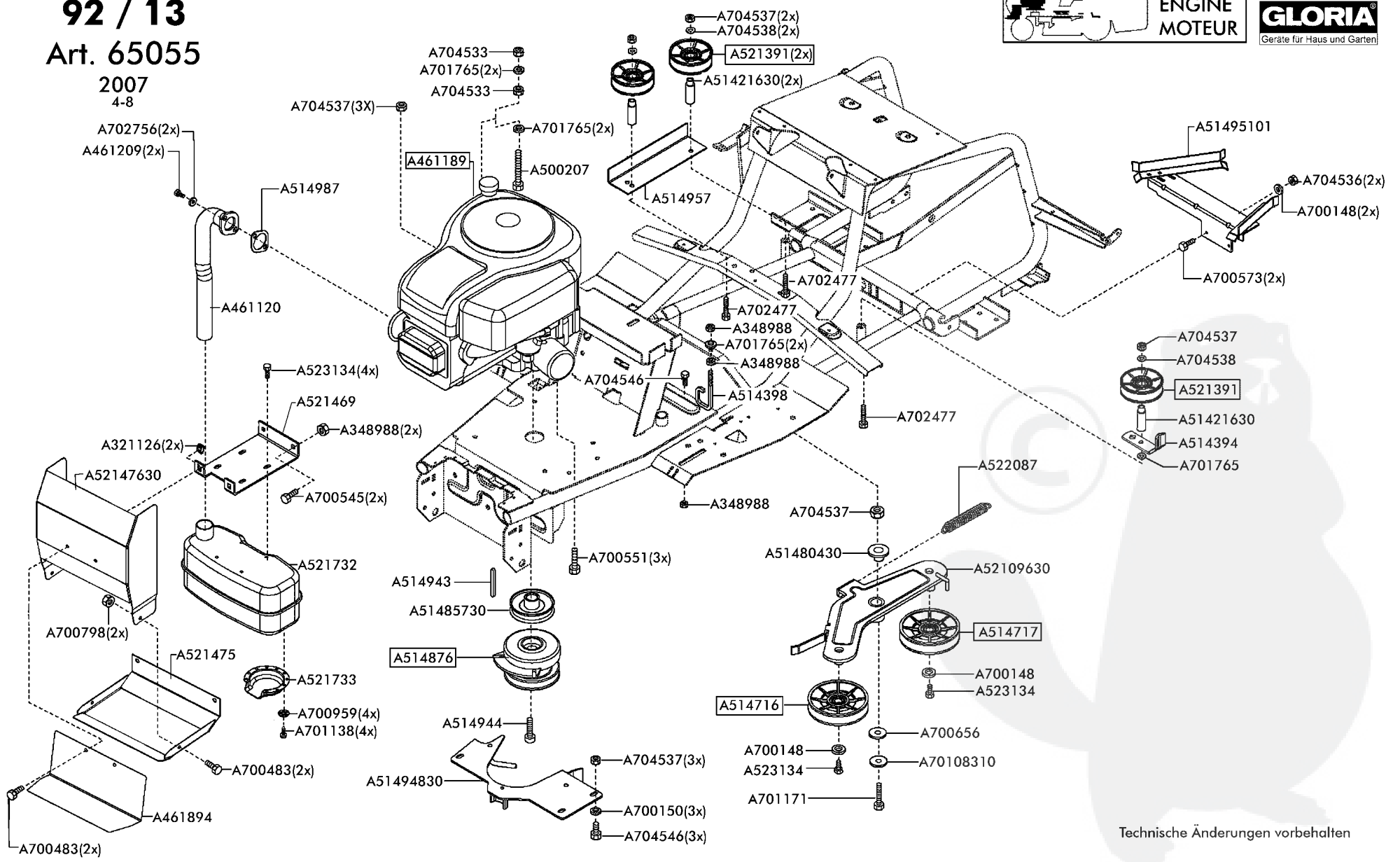
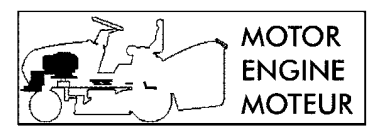

Crossover
92 / 13
Art. 65055
 2007
 4-8

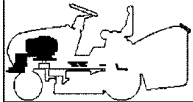

Technische Änderungen vorbehalten

| 11/22 | | RASENTRAKTOREN | | Crossover | |
|------------------------------|--------------------------------------|--|--|--|------|
| 2007 | | LAWN TRACTORS | | 92 / 13 - Art. 65055 | |
| Rev07380101 | | Tracteurs de pelouse | | Modell 2007 | |
| | |  MOTOR ENGINE MOTEUR | | 1/2   | |
| Bild Nr. REF.N° POS.N° | BEST.-NR. PART.-N° N° d. PIECE | BEZEICHNUNG | DESCRIPTION | DÉSIGNATION | Qty. |
| 1 | A321126 | MUTTER KASTEN- M 6-ST GALVZ+PASSI | NUT M 6-ST GALVZ+PASSI | ECROU M 6-ST GALVZ+PASSI | 2 |
| 2 | A348988 | MUTTER SICHERUNG BIW M 8 A3C- 8 MITTELGESICHERUNG | NUT | ECROU | 5 |
| 3 | A461120 | KRÜMMER B&S AUSPUFF GESCHW | EXHAUST CONNECTING TUBE | TUBE DE CONNEXION | 1 |
| 4 | A461189 | MOTOR B&S 13HP IC OHV AVS | ENGINE 13HP IC OHV AVS | MOTEUR 13HP IC OHV AVS | 1 |
| 5 | A461209 | SCHRAUBE ISKT UNC 5/16"X 3/4"A3B | SCREW | VIS | 2 |
| 6 | A461894 | ABWEISBLECH | PLATE | PLATEAU | 1 |
| 7 | A500207 | SCHRAUBE 8X 50 VERBUS RIPP A3R 8.8 | SCREW | VIS | 1 |
| 8 | A51421630 | ZENTRIERHÜLSE VERZ. | BUSHING | DOILLE | 3 |
| 9 | A514394 | RIEMENFÜHRUNG VERZ | BELT GUIDE | GUIDAGE COURROIE | 1 |
| 10 | A514398 | ÖSE-RIEMENFÜHRUNG MITTE | BELT GUIDE | GUIDAGE | 1 |
| 11 | A514716 | SPANNROLLE INNEN +LAGER | TENSIONER INSIDE ASSY | ROUE SERRAGE | 1 |
| 12 | A514717 | SPANNROLLE AUSSEN+LAGER | TENSION ROLL ASSY. OUTSIDE | ROUE SERRAGE À L'EXTÉRIEUR | 1 |
| 13 | A51480430 | DISTANZBUCHSE WIPPE VERZ | SPACER | ENTRETOISE | 1 |
| 14 | A51485730 | ANTRIEBSSEGMENT BBC 102 GESCHW VERZ | PULLEY | POULLIE | 1 |
| 15 | A514876 | ELEKTR. KUPPLUNG BBC-102 I-5217-4 E | ELECTR. CLUTCH ASSY BBC-102 I-5217-4 E | EMBRAYAGE ÉLECTROMAGNETIQUE BBC-102 I | 1 |
| 16 | A514943 | PASSFEDER 1/4"X1/4"X1"A | FIT-IN KEY | GOUPILLE | 1 |
| 17 | A514944 | SCHRAUBE UNF 7/16"X3" 10.9 | SCREW | VIS | 1 |
| 18 | A51494830 | RIEMENFÜHRUNG FAHRANTRIEB GESCHW VERZ | BELT GUIDE | GUIDE DE COURROIE | 1 |
| 19 | A51495101 | RIEMENFÜHRUNG HD102 GESCHW R9005 | BELT GUIDE | GUIDAGE COURROIE | 1 |
| 20 | A514957 | FÜHRUNGSBLECH 5-GANG 102 | PLATE | GUIDAGE | 1 |
| 21 | A514987 | FLANSCHDICHTUNG B&S 27229 | FLANGE SEAL | JOINT | 1 |
| 22 | A52109630 | SPANNROLLENWIPPE D16 GESCHW VERZ | LEVER D16 | LEVIER D16 | 1 |
| 23 | A521391 | UMLENKROLLE ALU+LAGER | PULLEY ASSY | POULIE GUIDAGE CPL | 3 |
| 24 | A521469 | AUSPUFFHALTEBLECH | SUPPORT | SUPPORT | 1 |
| 25 | A521475 | WÄRMELEITBLECH UNTEN H-4 UND 2 ZYLINDER | LOWER HEAT GUARD | DÉFLECTEUR CHALEUR EN BAS | 1 |
| 26 | A52147630 | LUFTLEITBLECH 2-ZYLINDER VERZ | AIR GUIDE | DÉFLECTEUR | 1 |
| 27 | A521732 | AUSPUFF B&S P 498984 | MUFFLER | SILENCEUX | 1 |
| 28 | A521733 | DEFLECTOR B&S P 222573 | DEFLECTOR | DEFLECTEUR | 1 |
| 29 | A522087 | ZUGFEDER-BBC | SPRING | RESSORT | 1 |
| 30 | A523134 | SFS-TAPT.M6X12 2021 A2K | SCREW | VIS | 6 |
| 31 | A700148 | SCHEIBE 6,4 9021-ST VZ | WASHER | RONDELLE | 4 |
| 32 | A700150 | SCHEIBE 8,4 9021-ST VZ | WASHER | RONDELLE | 3 |
| 33 | A700483 | SCHRAUBE 6X 12 933- 8.8VZ | SCREW | VIS | 4 |
| 34 | A700545 | SCHRAUBE 8X 16 933- 8.8VZ | SCREW 8X 16 933- 8.8VZ | VIS 8X 16 933- 8.8VZ | 2 |
| 35 | A700551 | SCHRAUBE 8X 35 933- 8.8A3C | SCREW | VIS | 3 |
| 36 | A700573 | SCHRAUBE 6X 20 603- 4.6VZ | SCREW | VIS | 2 |
| 37 | A700656 | FED TEL 28 X10,2X1,25 2093 | DISK SPRING | DISQUE | 1 |

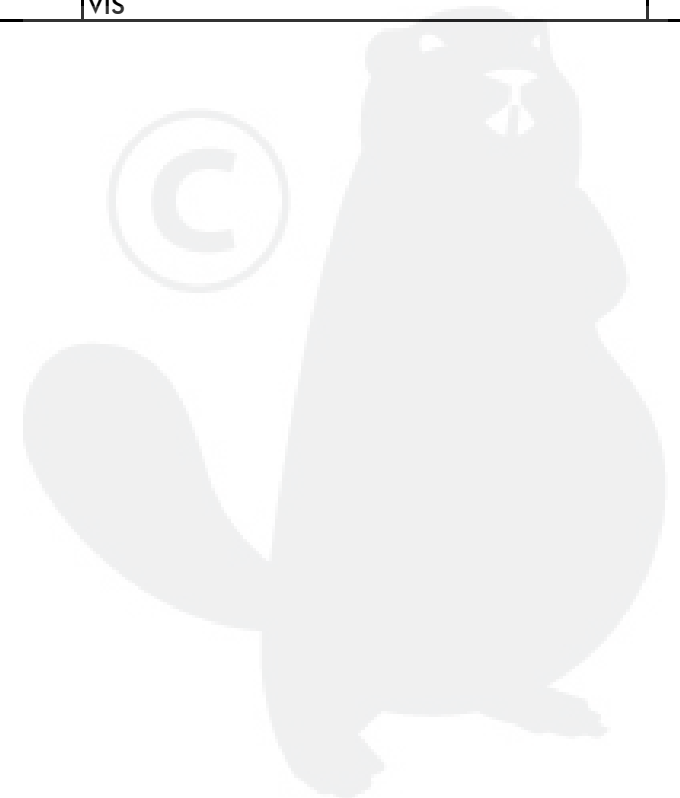

| 12/22 | | RASENTRAKTOREN | |  MOTOR ENGINE MOTEUR | | Crossover | |   <small>Gloria für Haus und Garten</small> | |
|------------------------------|-------------------------------------|-----------------------------------|------------------------------|---|------|----------------------|--|--|--|
| 2007 | | LAWN TRACTORS | | | | 92 / 13 - Art. 65055 | | | |
| Rev07380101 | | Tracteurs de pelouse | | | | Modell 2007 | | | |
| Bild Nr. REF.N° POS.N° | BEST.-NR. PART-N° N° d. PIECE | BEZEICHNUNG | DESCRIPTION | DÉSIGNATION | Qty. | | | | |
| 38 | A700798 | MUTTER 6KT 6 980-V- 8 | NUT | ECROU | 2 | | | | |
| 39 | A700959 | SHB FÄCHER- A 4,3 6798 VZ | WASHER | RONDELLE | 4 | | | | |
| 40 | A701011 | SCHRAUBE 8X 50 933- 8.8VZ | SCREW | VIS | 1 | | | | |
| 41 | A70108310 | SCHEIBE 8,4VZ7349"701083" | WASHER | RONDELLE | 1 | | | | |
| 42 | A701138 | SCHRAUBE ST4,2X13 -C-H7981 VZ | SCREW | VIS | 4 | | | | |
| 43 | A701171 | SCHRAUBE 8X 30 933- 8.8VZ | SCREW | VIS | 1 | | | | |
| 44 | A701765 | SCHEIBE FÄCHER- A 8,4 6798 VZ | WASHER FÄCHER- A 8,4 6798 VZ | RONDELLE A 8,4 6798 VZ | 7 | | | | |
| 45 | A702477 | SCHRAUBE 8X 80 931- 8.8VZ | SCREW | VIS | 3 | | | | |
| 46 | A702756 | SCHEIBE SICH SCHNORR S 8 MECHANVZ | WASHER | RONDELLE | 2 | | | | |
| 47 | A704533 | MUTTER 8 934- 8 A3B | NUT | ECROU | 2 | | | | |
| 48 | A704536 | MUTTER 6KT 6 985- 8 A3B | NUT | ECROU | 2 | | | | |
| 49 | A704537 | MUTTER 6KT 8 985- 8 A3B | NUT | ECROU | 10 | | | | |
| 50 | A704538 | SCHEIBE A 8,4 125-ST A3B | WASHER | RONDELLE | 3 | | | | |
| 51 | A704546 | SCHRAUBE 8X 20 933- 8.8A3B | SCREW | VIS | 4 | | | | |

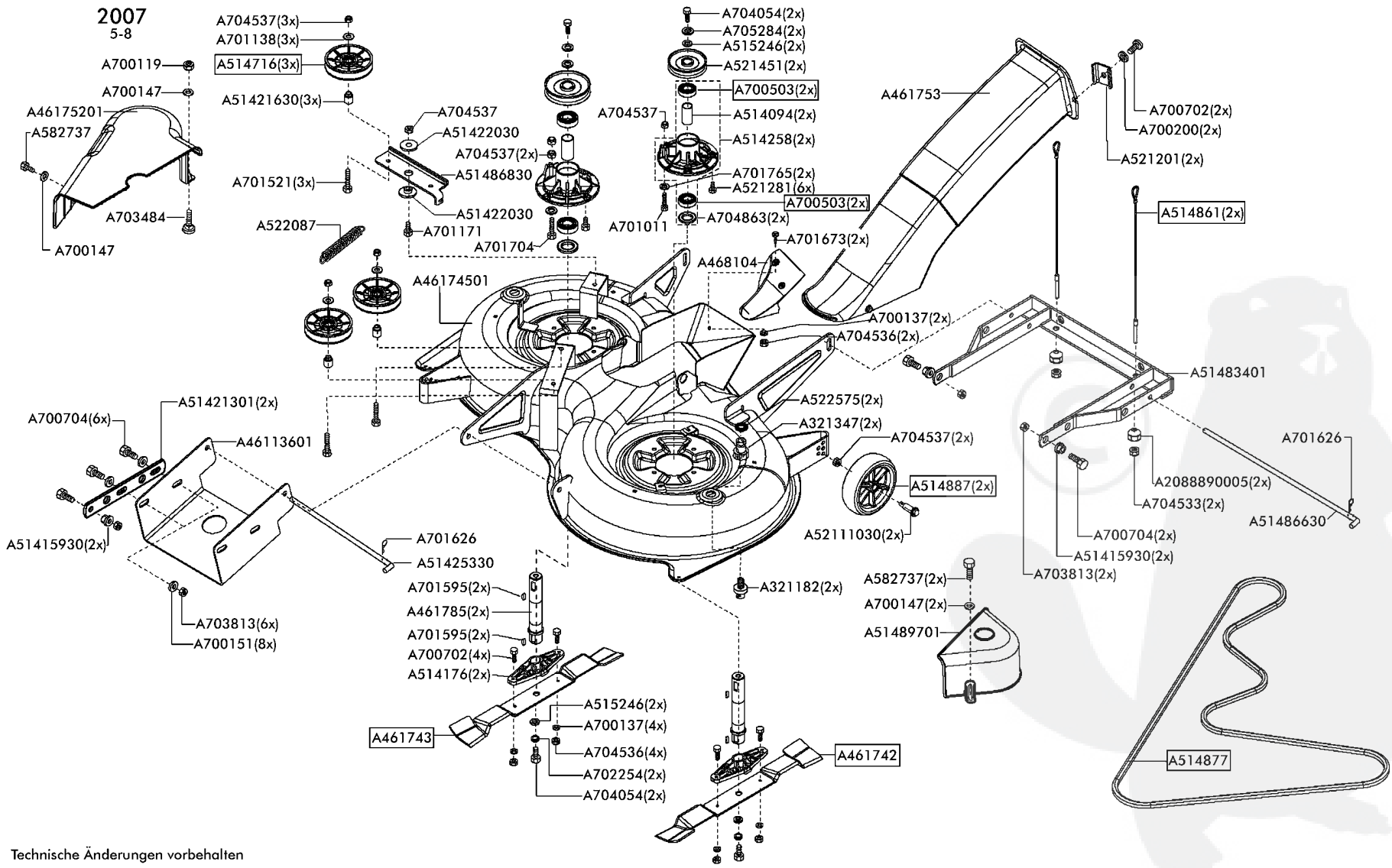

Crossover
92 / 13
Art. 65055



Technische Änderungen vorbehalten

| 14/22 | RASENTRAKTOREN |  | SCHNEIDWERK CUTTING PLATE PLATEAU DE COUPE | Crossover | |
|------------------------------|--------------------------------------|--|--|------------------------------------|---|
| 2007 | LAWN TRACTORS | | | 92 / 13 - Art. 65055 | 1/2  |
| Rev07380101 | Tracteurs de pelouse | | | Modell 2007 |  |
| Bild Nr. REF.N° POS.N° | BEST.-NR. PART.-N° N° d. PIECE | BEZEICHNUNG | DESCRIPTION | DÉSIGNATION | Qty. |
| 1 | A2088890005 | KUGELMUTTER M8 | NUT | ECROU | 2 |
| 2 | A321182 | SPÜLDÜSE R1/2" | WATER HOSE CONNECTION | RACCORD TUYAU D'EAU | 2 |
| 3 | A321347 | ANSCHLUSS R1/2" | TUBE ADAPTER | ADAPTER TUYAU | 2 |
| 4 | A46113601 | MÄHDECKAUFHÄNGUNG VORNE R9005 | CUTTING PLATE SUPPORT FRONT | PLATEAU SUSPENSION L'AVANT | 1 |
| 5 | A461742 | MESSER 487MM LINKS | BLADE LEFT 487 MM | LAME GAUCHE 487 MM | 1 |
| 6 | A461743 | MESSER 487MM RECHTS | BLADE RIGHT 487 MM | BLADE LEFT 487 MM | 1 |
| 7 | A46174501 | SCHNEIDGEHÄUSE 92 CM GESCHW R9005 | CUTTING DECK 92 CM R9005 | CARTER 92 CM R9005 | 1 |
| 8 | A46175201 | ABDECKUNG MÄHANTRIEB RECHTS R9005 95 | COVER RIGHT; CUTTING DRIVE | COUVERCLE DE PROTECTION COM.TONDRE | 1 |
| 9 | A461753 | AUSWURFKANAL 92CM | FUNNEL 92 CM | CANAL CRACHAT | 1 |
| 10 | A461785 | MESSERWELLE TRAKTOR VERZ | BLADE SHAFT | ABRE | 2 |
| 11 | A468104 | 6160-701-1600-A EINSATZ"KANALZUNGE" | FUNNEL INSERT 6160-701-1600-A | CANAL INSERT | 1 |
| 12 | A514094 | DISTANZBUCHSE-1 | SPACER | ENTRETOISE | 2 |
| 13 | A51415930 | DISTANZSCHEIBE VERZ | SPACER | ENTRETOISE | 4 |
| 14 | A514176 | MESSERHALTER | BLADE FLANGE | BRIDE | 2 |
| 15 | A51421301 | SCHENKEL-VORNE HÖHENVERSTELLUNG R9005 | SUPPORT | SUPPORT | 2 |
| 16 | A51421630 | ZENTRIERHÜLSE VERZ. | BUSHING | DOILLE | 3 |
| 17 | A51422030 | DISTANZSCHEIBE VERZ | SPACER | ENTRETOISE | 2 |
| 18 | A51425330 | ABSTECKSTANGE VERZ. | ROD | BARRE | 1 |
| 19 | A514258 | LAGERBOCK KPL. | BLADE FLANGE ASSY. CPL | ENS. BRIDE POUR LAME CPL | 2 |
| 20 | A514716 | SPANNROLLE INNEN +LAGER | TENSIONER INSIDE ASSY | ROUE SERRAGE | 3 |
| 21 | A51483401 | AUFHÄNGUNG HINTEN 102 GESCHW R9005 | REAR FRAME | SUSPENSION ARRIÈRE 102 | 1 |
| 22 | A514861 | DRAHTSEIL | STEEL WIRE ROPE | CABLE D'ACIER | 2 |
| 23 | A51486630 | ABSTECKSTANGE HINTEN VERZ | ROD | BARRE | 1 |
| 24 | A51486830 | SPANNWIPPE BBC VZKT | SUPPORT | SUPPORT | 1 |
| 25 | A514877 | MÄHANTRIEBSRIEMEN 102 | V-BELT 102 | COURROIE 102 | 1 |
| 26 | A514887 | RAD 125 R9005 | WHEEL 125 CPL | ROUE CPL 125 | 2 |
| 27 | A51489701 | ABDECKUNG MÄHANTRIEB LINKS R9005 | BELT COVER LEFT | BARRIÈRE GAUCHE CPL | 1 |
| 28 | A515246 | SCHEIBE 30/10,5 X 5 | WASHER | RONDELLE | 4 |
| 29 | A52111030 | RADBOLZEN 102 VERZ | WHEEL BOLT | BOULLON ROUE | 2 |
| 30 | A521201 | FIXIERUNGSSCHEIBE 102 | FIXING PLATE | PLATEAU FIXATION | 2 |
| 31 | A521281 | SCHRAUBE-TAPT 8X25 SPERRZ.A3S | SCREW | VIS | 6 |
| 32 | A521451 | RIEMENSCHLEIBE VERSCHRAUBT 102 KPL | PULLEY ASSY | POULIE | 2 |
| 33 | A522087 | ZUGFEDER-BBC | SPRING-BBC | RESSORT-BBC | 1 |
| 34 | A522575 | O-RING D10,78X2,62 NBR | O-RING | O-RING | 2 |
| 35 | A582737 | SCHRAUBE DUO-TAP 5X10-C ST A2K | SCREW DUO-TAP 5X10-C ST A2K | VIS DUO-TAP 5X10-C ST A2K | 3 |
| 36 | A700119 | MUTTER 6KT 5 985- 8 VZ | NUT | ECROU | 1 |
| 37 | A700137 | SCHEIBE A 6,4 125-ST VZ | WASHER | RONDELLE | 6 |

| 15/22 | RASENTRAKTOREN |  | SCHNEIDWERK | Crossover | | 2/2   |
|------------------------------|--------------------------------------|--|------------------------------|------------------------|------|--|
| 2007 | LAWN TRACTORS | | CUTTING PLATE | 92 / 13 - Art. 65055 | | |
| Rev07380101 | Tracteurs de pelouse | | PLATEAU DE COUPE | Modell 2007 | | |
| Bild Nr. REF.N° POS.N° | BEST.-NR. PART.-N° N° d. PIECE | BEZEICHNUNG | DESCRIPTION | DÉSIGNATION | Qty. | |
| 38 | A700147 | SCHEIBE 5,3 9021-ST VZ | WASHER | RONDELLE | 4 | |
| 39 | A700150 | SCHEIBE 8,4 9021-ST VZ | WASHER | RONDELLE | 8 | |
| 40 | A700151 | SCHEIBE 10,5 9021-ST VZ | WASHER | RONDELLE | 8 | |
| 41 | A700200 | SCHEIBE FÄCHER- J 6,4 6798 VZ | WASHER | RONDELLE | 2 | |
| 42 | A700503 | KUGELLAGER 6205 2RS 625 | BALL BEARING | ROULEMENT À BILLES | 4 | |
| 43 | A700702 | SCHRAUBE 6X 25 933- 8.8VZ | SCREW | VIS | 6 | |
| 44 | A700704 | SCHRAUBE10X 30 933- 8.8VZ | SCREW | VIS | 8 | |
| 45 | A701011 | SCHRAUBE 8X 50 933- 8.8VZ | SCREW | VIS | 1 | |
| 46 | A701138 | SCHRAUBE ST4,2X13 -C-H7981 VZ | SCREW | VIS | 3 | |
| 47 | A701171 | SCHRAUBE 8X 30 933- 8.8VZ | SCREW | VIS | 1 | |
| 48 | A701521 | SCHRAUBE 8X 40 933- 8.8VZ | SCREW | VIS | 3 | |
| 49 | A701595 | PASSFEDER 8X7X20 6885 | FIT-IN KEY | GOUPILLE | 3 | |
| 50 | A701626 | FEDERSTECKER - 2,5 11024 VZ | COTTER PIN | GOUPILLE | 2 | |
| 51 | A701673 | SCHRAUBE 6X 25 603- 4.6VZ | SCREW 6X 25 603- 4.6VZ | VIS 6X 25 603- 4.6VZ | 2 | |
| 52 | A701704 | SCHRAUBE 8X 60 933- 8.8VZ | SCREW | VIS | 1 | |
| 53 | A701765 | SCHEIBE FÄCHER- A 8,4 6798 VZ | WASHER FÄCHER- A 8,4 6798 VZ | RONDELLE A 8,4 6798 VZ | 2 | |
| 54 | A702254 | SCHEIBE FÄCHER- A 10,5 6798 VZ | WASHER | RONDELLE | 2 | |
| 55 | A703484 | SCHRAUBE 5X 16 603- 4.6A3C | SCREW | VIS | 1 | |
| 56 | A703813 | MUTTER 6KT 10 985-10 A3B | NUT | ECROU | 8 | |
| 57 | A704054 | SCHRAUBE10X1,0 X 35 961- 8.8 | SCREW | VIS | 4 | |
| 58 | A704533 | MUTTER 8 934- 8 A3B | NUT | ECROU | 2 | |
| 59 | A704536 | MUTTER 6KT 6 985- 8 A3B | NUT | ECROU | 6 | |
| 60 | A704537 | MUTTER 6KT 8 985- 8 A3B | NUT | ECROU | 9 | |
| 61 | A704863 | RWDR AS 30X 52X 5 3760-NB | WASHER | RONDELLE | 2 | |
| 62 | A705284 | TELLERFEDER 28 X10,2X1,5 2093 | DISK SPRING | RESSORT D'ASSIETTE | 2 | |

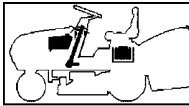

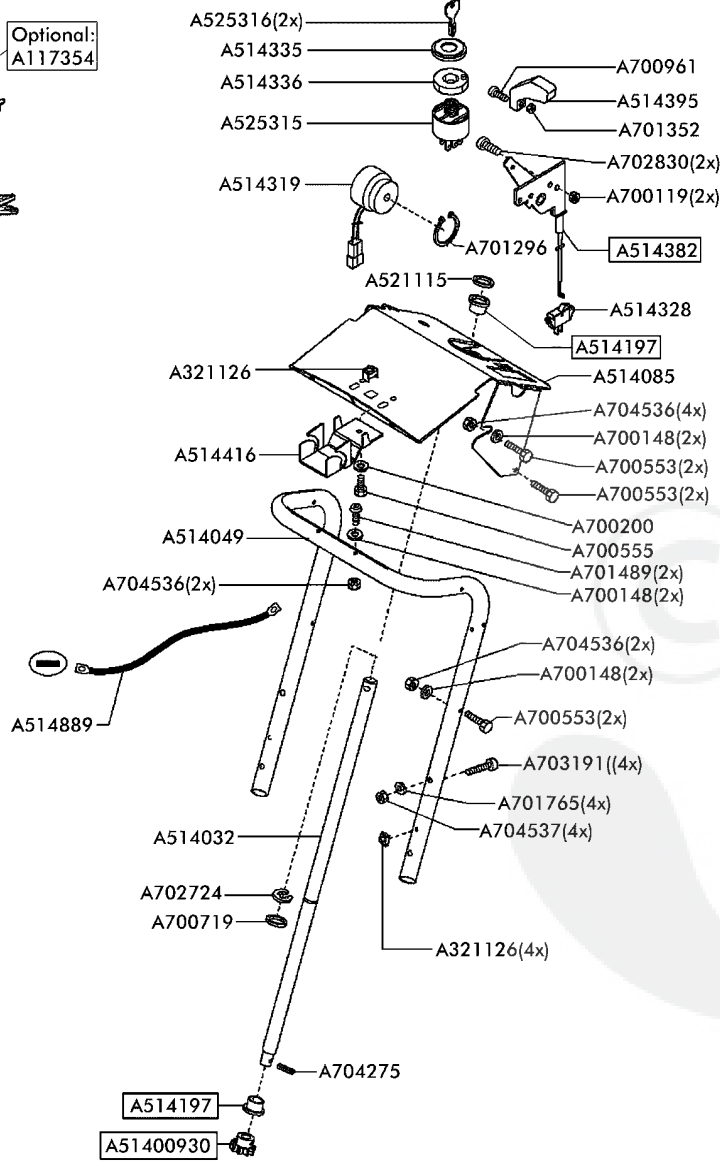
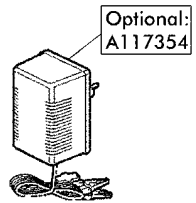
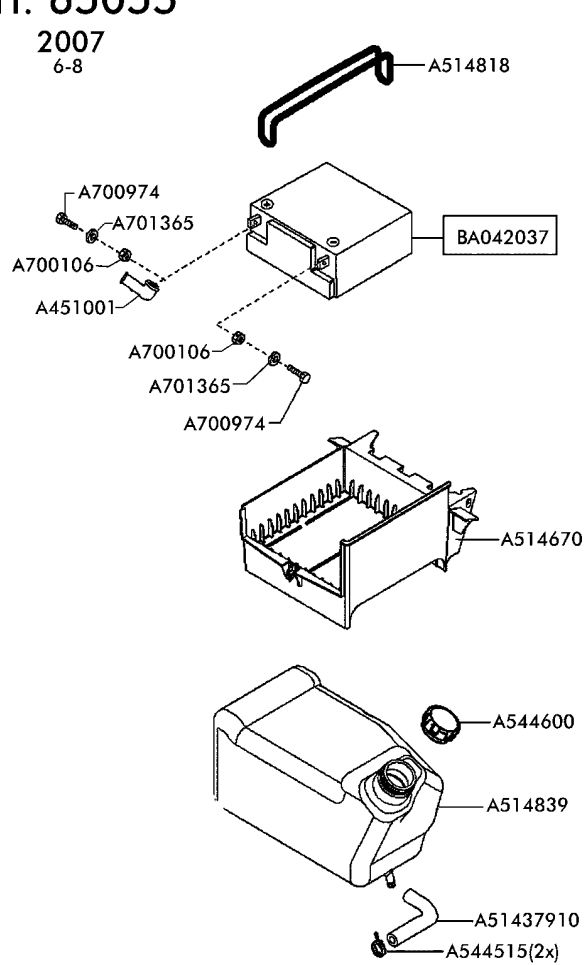
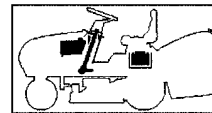

Crossover
92 / 13
Art. 65055
2007
 6-8

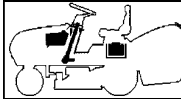

Technische Änderungen vorbehalten

| 17/22 | | RASENTRAKTOREN | |  TANK, BATTERIE & KOMponentEN TANK, BATTERY & COMPONENTS TANK, BATTERIE & COMPOSANTS | | Crossover | | 92 / 13 - Art. 65055 | | 1/2 | |
|------------------------------|--------------------------------------|---------------------------------------|-----------------------------------|--|------|-------------|--|----------------------|--|--------|--|
| 2007 | | LAWN TRACTORS | | | | Modell 2007 | | BRILL | | GLORIA | |
| Rev07380101 | | Tracteurs de pelouse | | | | | | | | | |
| Bild Nr. REF.N° POS.N° | BEST.-NR. PART.-N° N° d. PIECE | BEZEICHNUNG | DESCRIPTION | DÉSIGNATION | Qty. | | | | | | |
| 1 | A117354 | LADEGERÄT Crossover 12 V (optional) | CHARGER Crossover 12 V (optional) | CHARGEUR Crossover 12 V (optional) | 1 | | | | | | |
| 2 | A321126 | MUTTER KASTEN- M 6-ST GALVZ+PASSI | NUT | ECROU | 5 | | | | | | |
| 3 | A451001 | BATTERIEPOLABDECKUNG FÜR BATTERIE CSB | POL COVER | COUVERCLE DE PROTECTION | 1 | | | | | | |
| 4 | A51400930 | LENKUNGSRITZEL VERZ. | STEERING WHEEL | PIGNON | 1 | | | | | | |
| 5 | A514032 | LENKSÄULE VERZ | STEERING COLUMN | TUBE DE DIRECTION | 1 | | | | | | |
| 6 | A514049 | STÜTZHOLM | SUPPORT | SUPPORT | 1 | | | | | | |
| 7 | A514085 | STÜTZBLECH | SUPPORT | SUPPORT | 1 | | | | | | |
| 8 | A514197 | EP-BUNDBUCHSE | BUSH | DOILLE | 2 | | | | | | |
| 9 | A514319 | FÜLLSTANDSUMMER | BUZZER (GRASS BAG FULL) | BUZZER | 1 | | | | | | |
| 10 | A514328 | KIPPSCHALTER LICHT | ROCKER SWITCH I/O | INERRUPTEUR À BASCULE | 1 | | | | | | |
| 11 | A514335 | BEFESTIGUNGS MUTTER ZÜNDSCHLOSS | LOCK NUT | EMBOUT | 1 | | | | | | |
| 12 | A514336 | VERDREHSICHERUNG ZÜNDSCHLOSS | SAFETY NUT | EMBOUT | 1 | | | | | | |
| 13 | A51437910 | BENZINSCHLAUCH ZUSCHNITT | CONNECTING TUBE | TUBE DE CONNEXION | 1 | | | | | | |
| 14 | A514382 | GASFERNBEDIENUNG | ACCELERATOR | ACCELERATEUR | 1 | | | | | | |
| 15 | A514395 | BEDIENHEBEL | LEVER | LEVIER | 1 | | | | | | |
| 16 | A514416 | EINRASTBLECH | ENGAGE PLATE | PANNEAU ENCLIQUETER | 1 | | | | | | |
| 17 | A514670 | BATTERIEKASTEN | BATTERY INSERT | BATTERIE CAISSE | 1 | | | | | | |
| 18 | A514818 | BEFESTIGUNGSGUMMI | RUBBER BAND | ÉLASTIQUE | 1 | | | | | | |
| 19 | A514839 | BENZINTANK | TANK | RESERVOIR | 1 | | | | | | |
| 20 | A514889 | ZUSATZ MASSEKABEL | GROUND CABLE | CABLE | 1 | | | | | | |
| 21 | A521115 | SCHNELLBEFESTIGER20SXN26 | CROWN FASTENER | FIXATEUR A COURONNE | 1 | | | | | | |
| 22 | A525315 | ZÜNDANLASSCHALTER RIDER | IGNITION SWITCH | INTERRUPTEUR DEMARR. /1 | 1 | | | | | | |
| 23 | A525316 | ZÜNDSCHLÜSSEL | STARTING KEY | CLEF A DEMARRAGE | 2 | | | | | | |
| 24 | A544515 | SCHLAUCHKLEMME 14,5 | TUBE CLAMP | BORNE | 2 | | | | | | |
| 25 | A544600 | TANKDECKEL KPL | TANK CAP | BOUCHON DE RÉSERVOIR | 1 | | | | | | |
| 26 | A700106 | MUTTER 5 934- 8 VZ | NUT | ECROU | 2 | | | | | | |
| 27 | A700119 | MUTTER 6KT 5 985- 8 VZ | NUT | ECROU | 2 | | | | | | |
| 28 | A700148 | SCHEIBE 6,4 9021-ST VZ | WASHER | RONDELLE | 6 | | | | | | |
| 29 | A700200 | SCHEIBE FÄCHER- J 6,4 6798 VZ | WASHER | RONDELLE | 1 | | | | | | |
| 30 | A700553 | SCHRAUBE 6X 40 933- 8.8VZ | SCREW | VIS | 6 | | | | | | |
| 31 | A700555 | SCHRAUBE 6X 16 933- 8.8VZ | SCREW | VIS | 1 | | | | | | |
| 32 | A700719 | SCHEIBE 21 433 VZ | WASHER | RONDELLE | 1 | | | | | | |
| 33 | A700961 | SCHRAUBE 4X 8 7985- 4.8-H VZ | SCREW | VIS | 1 | | | | | | |
| 34 | A700974 | SCHRAUBE 5X 16 933- 8.8VZ | SCREW | VIS | 2 | | | | | | |
| 35 | A701296 | SICHERUNGSRING 25X1,2 471 | CIRCLIP | CIRCLIPS | 1 | | | | | | |
| 36 | A701352 | MUTTER 6KT 4 985- 8 VZ | NUT | ECROU | 1 | | | | | | |
| 37 | A701365 | SCHEIBE FÄCHER- A 5,3 6798 VZ | WASHER | RONDELLE | 2 | | | | | | |

| 18/22 | RASENTRAKTOREN |  TANK, BATTERIE & KOMPONENTEN TANK, BATTERY & COMPONENTS TANK, BATTERIE & COMPOSANTS | Crossover 92 / 13 - Art. 65055 Modell 2007 | | 2/2   |
|------------------------------|-------------------------------------|--|--|--------------------------------|--|
| 2007 | LAWN TRACTORS | | | | |
| Rev07380101 | Tracteurs de pelouse | | | | |
| Bild Nr. REF.N° POS.N° | BEST.-NR. PART-N° N° d. PIECE | BEZEICHNUNG | DESCRIPTION | DÉSIGNATION | Qty. |
| 38 | A701489 | SCHRAUBE 6X 35 933- 8.8VZ | SCREW | VIS | 2 |
| 39 | A701765 | SCHEIBE FÄCHER- A 8,4 6798 VZ | WASHER FÄCHER- A 8,4 6798 VZ | RONDELLE FÄCHER- A 8,4 6798 VZ | 4 |
| 40 | A702724 | SCHEIBE SICH 15 6799 VZ | WASHER | RONDELLE | 1 |
| 41 | A702830 | SCHRAUBE 5X 12 7985- 4.8-H A3R | SCREW | VIS | 2 |
| 42 | A703191 | SCHRAUBE 8X 40 7991- 8.8A3C | SCREW | VIS | 4 |
| 43 | A704275 | SPANNSTIFT 6X24 7344 | PIN | GOUPILLE | 1 |
| 44 | A704536 | MUTTER 6KT 6 985- 8 A3B | NUT | ECROU | 8 |
| 45 | A704537 | MUTTER 6KT 8 985- 8 A3B | NUT | ECROU | 4 |
| 46 | BA042037 | BATTERIE 12V-17Ah | BATTERY 12 V-17Ah | BATTERIE 12V-17Ah | 1 |



Crossover
92 / 13
Art. 65055
 2007
 7-8

GRASFANGSACK KPL.
 GRASS CATCHER ASSY.
 BAC COMPOSANTS

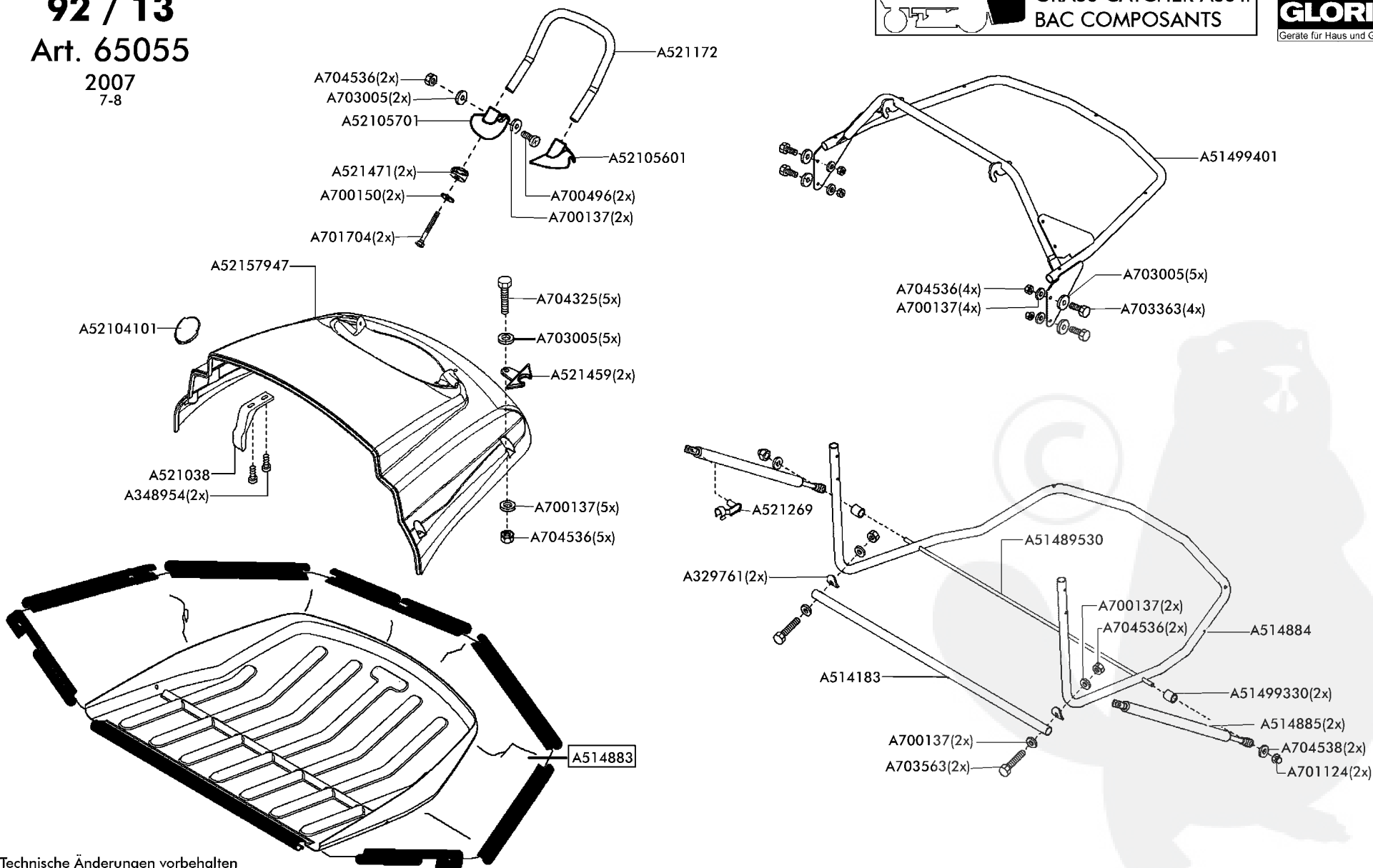

Technische Änderungen vorbehalten

| 20/22 | RASENTRAKTOREN |  | GRASFANGSACK KPL. | Crossover | |
|------------------------------|-------------------------------------|--|------------------------------------|------------------------------------|------|
| 2007 | LAWN TRACTORS | | GRASS CATCHER ASSY. | 92 / 13 - Art. 65055 | |
| Rev07380101 | Tracteurs de pelouse | | BAC COMPOSANTS | Modell 2007 | |
| Bild Nr. REF.N° POS.N° | BEST.-NR. PART-N° N° d. PIECE | BEZEICHNUNG | DESCRIPTION | DÉSIGNATION | Qty. |
| 1 | A329761 | SCHEIBE GEBOGEN H11 | CURVED WASHER H11 | RONDELLE COURBE | 2 |
| 2 | A348954 | SCHRAUBE.PT-KB 60X25 1411 VZ | SCREW | VIS | 2 |
| 3 | A514183 | QUERSTREBE BOX | ROD | TIGE | 1 |
| 4 | A514883 | GEWEBESACK 102 KPL | GRASS CATCHER BAG ASSY 102 | BAC | 1 |
| 5 | A514884 | BOXROHR UNTEN 102 | LOWER FRAME ASSY | CHASSIS INFÉRIEUR | 1 |
| 6 | A514885 | GASFEDER GF8-053550-130 | GAS PRESSURE SPRING GF8-053550-130 | RESSORT PNEUMATIQUE GF8-053550-130 | 2 |
| 7 | A51489530 | BOXSTREBE TRAKTOR 102 VERZ | BOX BAR | BAC HAUBAN | 1 |
| 8 | A51499330 | DISTANZHÜLSE BOX VERZ | DISTANCE SLEEVE | CALE DE DISTANCE | 2 |
| 9 | A51499401 | BOXROHR 102 GESCHW R9005 | BOX TUBE | BAC TUYAU | 1 |
| 10 | A521038 | KONTAKTWINKEL | BRACKET | EQUERRE-SUPPORT | 1 |
| 11 | A52104101 | VERSCHLUSSTOPFEN R9005 | CAP | BOUCHON | 1 |
| 12 | A52105601 | AUFSATZ LINKS R9005 | ADAPTER LEFT | ADAPTER GAUCHE | 1 |
| 13 | A52105701 | AUFSATZ RECHTS R9005 | ADAPTER RIGHT | ADAPTER DROITE | 1 |
| 14 | A521172 | BOXGRIFF + ROHREINS.M8 KP | HANDLE | POINGEE | 1 |
| 15 | A521269 | FEDERKLAPPBOLZEN FKB 6X12 | SPRING SNAP BOLT | BOULON BLOQUER | 1 |
| 16 | A521459 | CLIP FÜR GASDÄMPFERBEFESTIGUNG | CLIP | CLIP | 2 |
| 17 | A521471 | UNTERLAGSCHEIBE FÜR GRIFF | WASHER | RONDELLE | 2 |
| 18 | A52157947 | BOXDECKEL TR 2X BOHREN | BAG COVER | COUVRE-BAC VERT | 1 |
| 19 | A700137 | SCHEIBE A 6,4 125-ST VZ | WASHER | RONDELLE | 15 |
| 20 | A700150 | SCHEIBE 8,4 9021-ST VZ | WASHER | RONDELLE | 2 |
| 21 | A700496 | SCHRAUBE 6X 20 912- 8.8 | SCREW | VIS | 2 |
| 22 | A701124 | MUTTER HUT 8 986- 8 VZ | NUT | ECROU | 2 |
| 23 | A701704 | SCHRAUBE 8X 60 933- 8.8VZ | SCREW | VIS | 2 |
| 24 | A703005 | SCHEIBE 6,4 9021-ST A3S | WASHER | RONDELLE | 12 |
| 25 | A703363 | SCHRAUBE 6X 35 933- 8.8A3S | SCREW | VIS | 4 |
| 26 | A703563 | SCHRAUBE 6X 45 933- 8.8A3C | SCREW | VIS | 2 |
| 27 | A704325 | SCHRAUBE 6X 40 933- 8.8A3S | SCREW | VIS | 5 |
| 28 | A704536 | MUTTER 6KT 6 985- 8 A3B | NUT | ECROU | 13 |
| 29 | A704538 | SCHEIBE A 8,4 125-ST A3B | WASHER | RONDELLE | 2 |



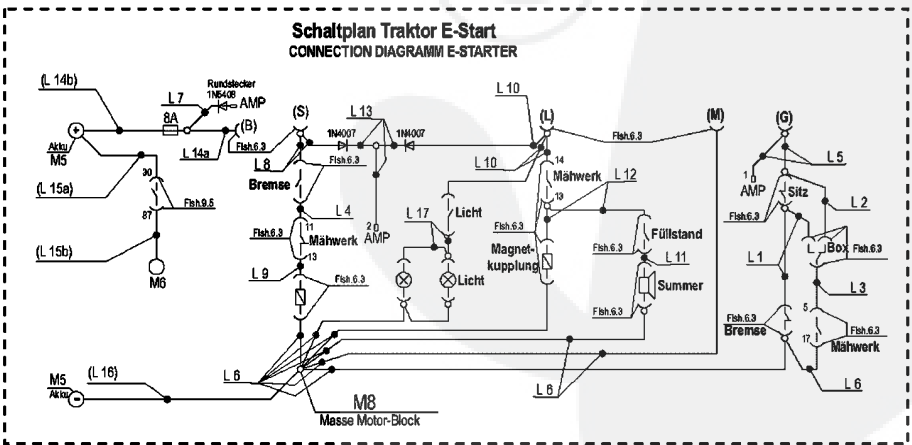
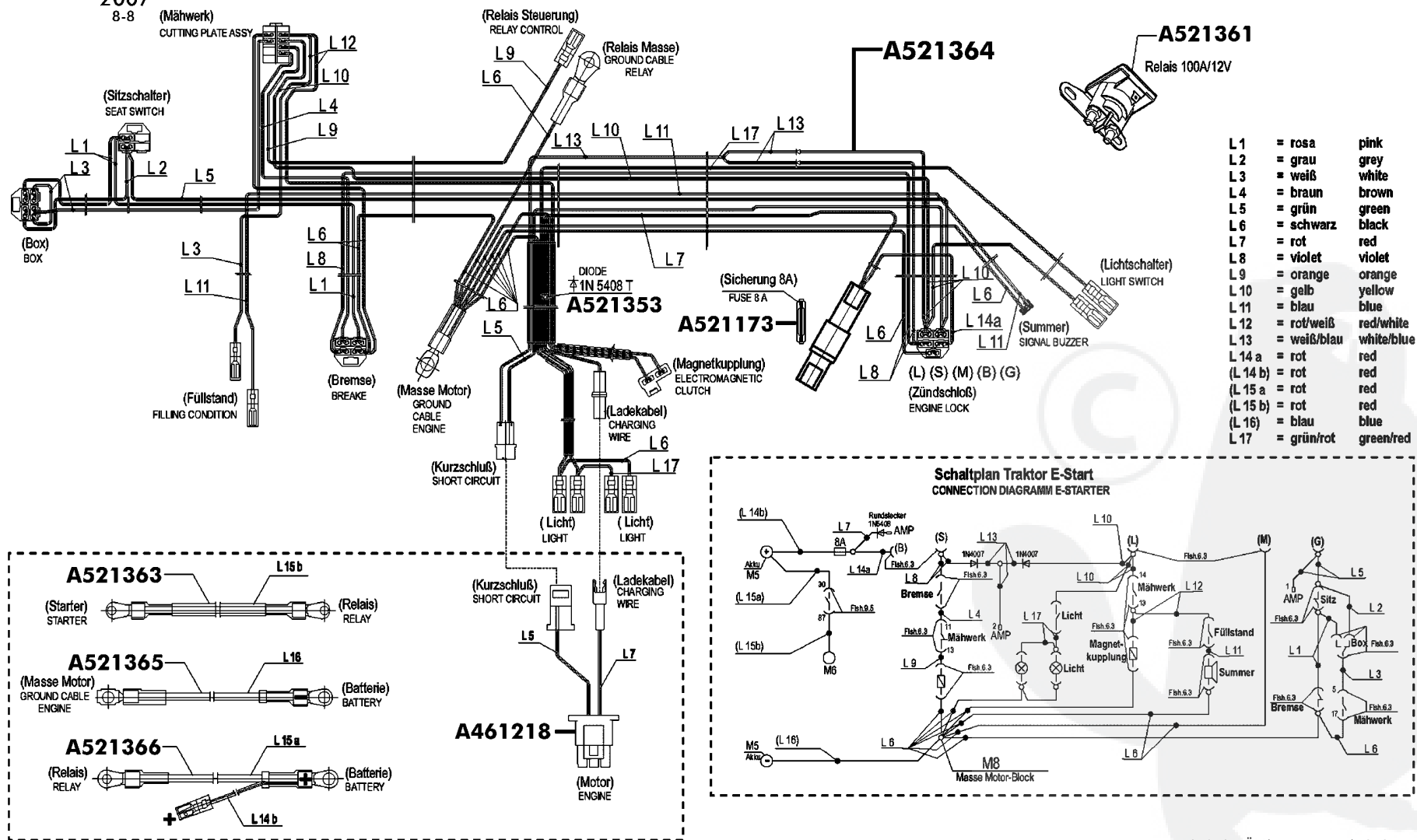

Crossover
92 / 13
Art. 65055
2007

ELEKTRIK 1
ELECTRIC 1
ELECTRIQUES 1

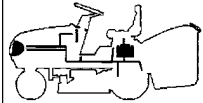

Technische Änderungen vorbehalten

| 22/22 | RASENTRAKTOREN |  | ELEKTRIK 1 ELECTRIC 1 ELECTRIQUES 1 | Crossover | |  | |
|------------------------------|-------------------------------------|--|---|----------------------------------|------|---|---|
| 2007 | LAWN TRACTORS | | | 92 / 13 - Art. 65055 | | |  |
| Rev07380101 | Tracteurs de pelouse | | | Modell 2007 | | | |
| Bild Nr. REF.N° POS.N° | BEST.-NR. PART-N° N° d. PIECE | BEZEICHNUNG | DESCRIPTION | DÉSIGNATION | Qty. | | |
| 1 | A461218 | ADAPTER FÜR KABELB TEC 14 HP+13 HP B&S | ADAPTER FOR TEC 14 HP+13 HP B&S | ADAPTER POUR TEC 14 HP+13 HP B&S | 1 | | |
| 2 | A521173 | SICHERUNG 8A | FUSE 8A | FUSIBLE 8A | 1 | | |
| 3 | A521353 | DIODE 5A IN5408 T ET | DIODE 5A | DIODE 5A | 1 | | |
| 4 | A521361 | STARTERRELAIS 12V/100AMPER | STARTER RELAY | RELAIS D'ALL. | 1 | | |
| 5 | A521363 | KABEL ROT STARTER/RELAIS | CABLE RED (RELAIS) | CABLE ROUGE (RELAIS) | 1 | | |
| 6 | A521364 | KABELBAUM E-START 102 | CABLES ASSY. E-START 102 | ENS. CABLAGES E-START 102 | 1 | | |
| 7 | A521365 | KABEL BLAU MASSELEITER | CABLE BLUE (GROUNG CABLE) | CABLE BLEU | 1 | | |
| 8 | A521366 | KABEL ROT BATTERIE/RELAIS | CABLE RED BATTERY * RELAIS | CABLE ROUGE (BATTERIE-RALAIS) | 1 | | |

