

SINCE 1839

**BRINLY**

SINCE 1839

**BRINLY**

# OWNER'S MANUAL

## **LAWN ROLLER**

ROLLER MODEL:

**PRC-241 BH**

**PRT-361 BH**

**PRT-361S BH**

**PRT-481S BH**

- Assembly
- Installation
- Operation
- Repair Parts

Recommended for use with Riding Mowers,  
Lawn or Garden Tractors, and ATV's.

\*PRC-241 Push version not shown

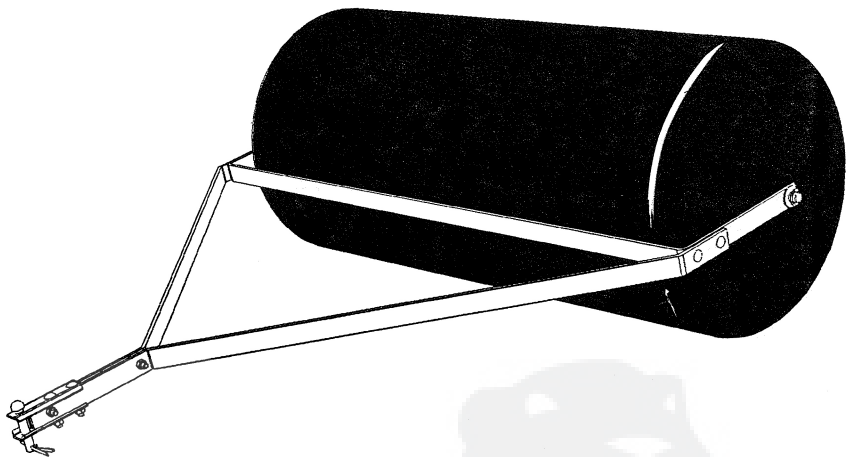

For the latest product updates and setup tips:

Visit us on the web  
[www.brinly.com](http://www.brinly.com)

Important: This manual contains information for the safety of persons and property. Read it carefully before assembly and operation of the equipment!

L-1681.00

CONGRATULATIONS on your new Brinly-Hardy Equipment! Your Equipment has been designed, engineered and manufactured to give you the best possible dependability and performance.

Should you experience any problem you cannot easily remedy, please do not hesitate to contact our **Customer Service Department** toll-free at **1-877-728-8224**.

Please read and retain this manual. The instructions will enable you to assemble and maintain your equipment properly. And please, always observe the "Safety Rules".

**CUSTOMER RESPONSIBILITIES**

Read and Observe the "Safety Rules".

Follow a regular schedule in maintaining, caring-for and using your Brinly-Hardy Equipment.

**TABLE OF CONTENTS**

SAFETY RULES .....2  
 HARDWARE.....3  
 PARTS REFERENCE .....4  
 PARTS LIST .....4  
 ASSEMBLY .....5-6  
 MAINTENANCE .....7  
 OPERATION .....7  
 WARRANTY.....7



**RULES FOR SAFE OPERATION**

- Know controls and how to stop towing equipment quickly. **READ THE OWNER'S MANUAL.**
- Do not allow children to operate the vehicle. Do not allow adults to operate without proper instruction or without having read the Owner's Manual.
- Do not carry passengers. Keep children and pets a safe distance away.
- Always wear substantial footwear. Do not wear loose-fitting clothing that can get caught in moving parts.
- Keep your eyes and mind on your towing equipment/attachment and area being covered. Do not let other interests distract you.
- Stay alert for holes in the terrain and other hidden hazards.
- Do not drive close to creeks, ditches, and public highways.
- Watch out for traffic when crossing or near roadways.
- When using any attachment, don't allow anyone near the vehicle while in operation.
- Keep the vehicle and attachment in good operating condition and keep safety devices in place.
- Keep all nuts, bolts, and screws tight to be sure the equipment is in safe working condition.
- The vehicle and attachment should be stopped and inspected for damage after striking any foreign object. The damage should be repaired before restarting and operating the equipment.
- See towing equipment Owner's Manual for safe operation of the equipment.

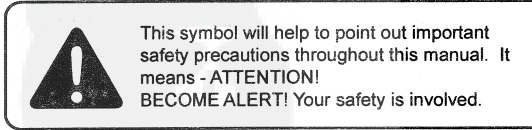

**Limited Warranty**

Brinly-Hardy Company warrants only to the original retail purchaser that this product will remain free of defects in workmanship and materials under normal use and service for a period of two (2) years (NOTE: ninety (90) days for commercial or rental use) commencing with the date of purchase.

Any parts found to be defective within the warranty period will be replaced, with proof of date of purchase, at Brinly-Hardy Company's expense. Our obligation under this warranty is expressly limited to replacement or repair, at our option of parts, which are defective in material or workmanship within thirty (30) days of receipt of the parts. This warranty does not apply to damage caused by unreasonable use, including failure to provide necessary maintenance, nor does it apply to any transportation or labor charges.

WE MAKE NO OTHER EXPRESS WARRANTY NOR IS ANYONE AUTHORIZED TO MAKE ANY ON OUR BEHALF. ANY IMPLIED OR STATUTORY WARRANTIES, INCLUDING ANY WARRANTY OF MERCHANTABILITY OR FITNESS FOR A PARTICULAR PURPOSE, ARE LIMITED TO THE DURATION OF THIS WRITTEN WARRANTY. WE SHALL NOT BE LIABLE FOR CONSEQUENTIAL OR INCIDENTAL DAMAGES OF ANY KIND.

MADE IN THE U.S.A.  
 BRINLY-HARDY COMPANY TOLL-FREE 1-877-728-8224

**HARDWARE REFERENCE**

This page is for reference use only  
All items shown full size unless otherwise specified

**Hardware Bag (Part No. Z-1724)**

**4**  
(4) Carriage Bolt, 5/16x 1"

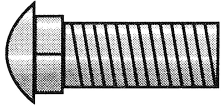

**5**  
(2) Carriage Bolt, 5/16x 1-1/2"

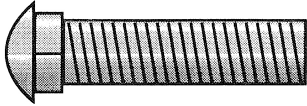

**6**  
(2) Carriage Bolt, 5/16x 2-1/4"

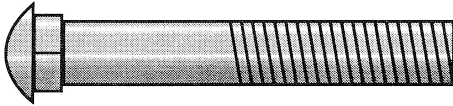

**8**  
(8) Nylon Lock Nut 5/16"



**11**  
(2) E-Ring 5/8"



**7**  
(4) Flat Washer, 5/8"

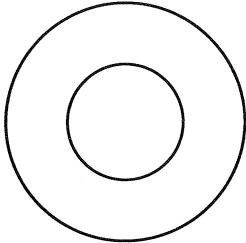

**10**  
(2) Square Bearing

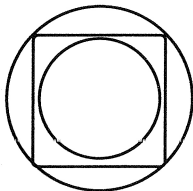

**12**  
(1) Frame Spacer



**9**  
(1) Plastic Plug  
not to scale

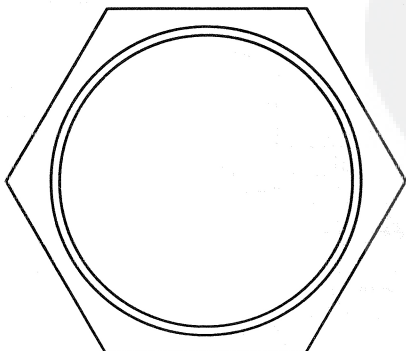

**Tools Required for Assembly:**  
\* 1/2" wrench (2)  
\* Pair slip joint pliers

**Hardware Bag (Part No. Z-1725)**

**20** (2) Clevis  
not to scale

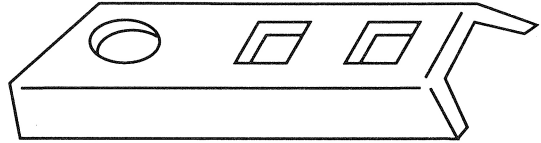

**14** (1) Hitch Pin Cotter

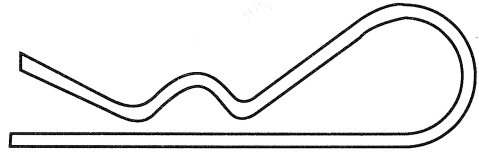

**13** (1) Hitch Pin

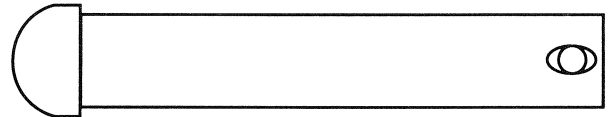

**Hardware Bag (Part No. Z-1723)**

**HARDWARE FOR THE PRC-241 BH ONLY!!!**

**16**  
(1) Hex Bolt 1/2" x 2-1/4"

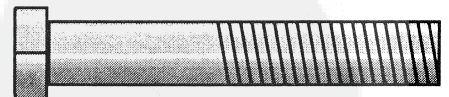

**17**  
(1) Hex Nut 1/2"



**18**  
(1) Lock Washer 1/2"

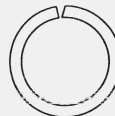

**19**  
(2) Grip  
not to scale

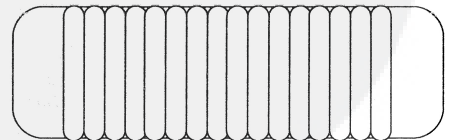

## Parts Reference

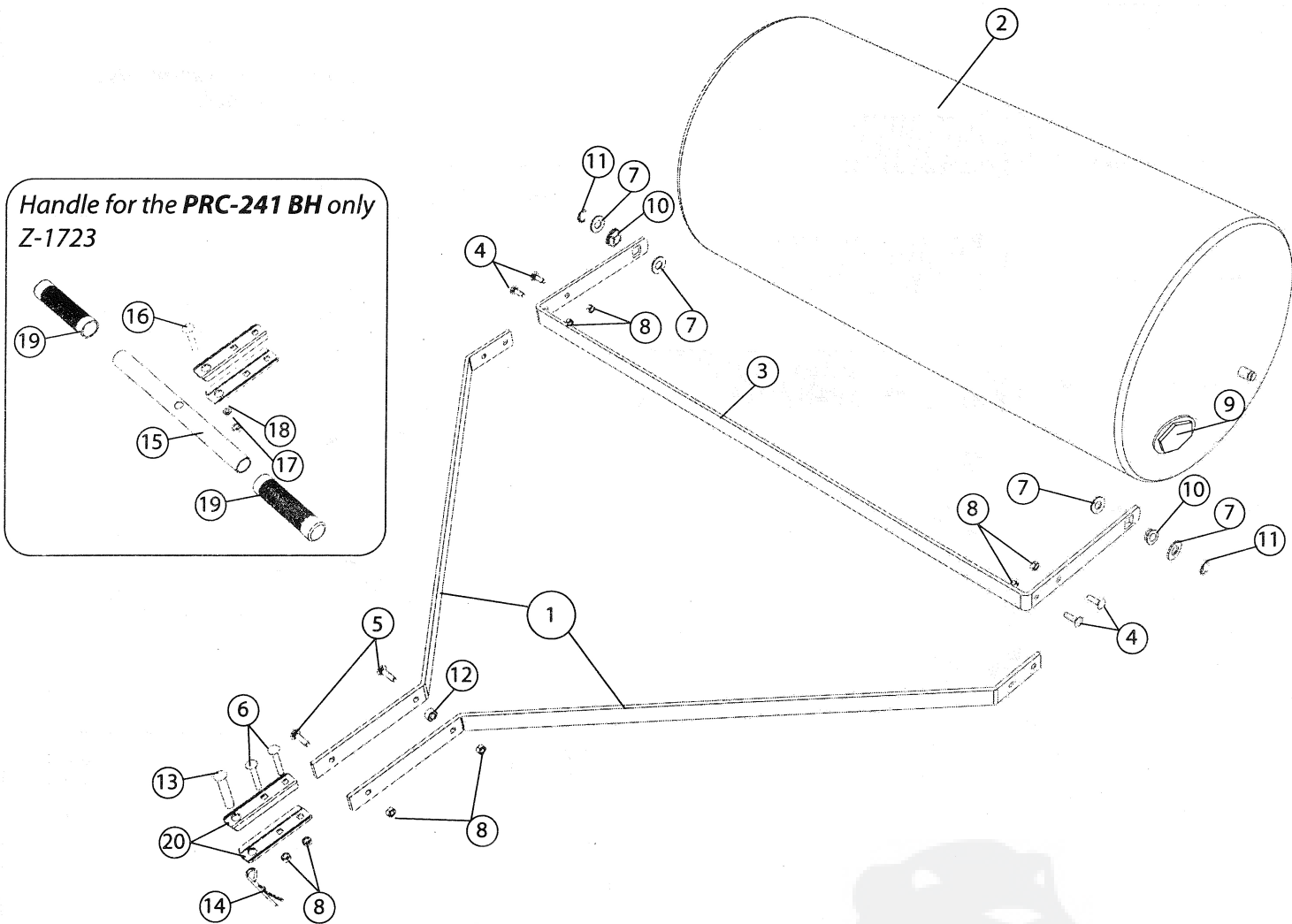

## Parts List

REF NO.	PART NO.				DESCRIPTION	QTY.
	PRC-241 BH	PRT-361 BH	PRT-361S BH	PRT-481S BH		
1	B-3554-10	B-6289-10	B-5357-10	B-6290-10	Frame Extension Bar	2
2	B-5121	B-6271	B-5353-B	B-5789-B	Roller Drum Assembly	1
3	B-6291-10	B-6272-10	B-6292-10	B-6294-10	Scraper Bar	1
* 4	11M1016P	11M1016P	11M1016P	11M1016P	5/16" x 1" Carriage Bolt	4
* 5	11M1024P	11M1024P	11M1024P	11M1024P	5/16" x 1-1/2" Carriage Bolt	2
* 6	11M1036P	11M1036P	11M1036P	11M1036P	5/16" x 2-1/4" Carriage Bolt	2
* 7	45M2121P	45M2121P	45M2121P	45M2121P	Flat Washer 5/8"	4
* 8	B-4786	B-4786	B-4786	B-4786	Nylon Lock Nut 5/16"	8
9	B-5121-PL	B-5121-PL	B-5121-PL	B-5121-PL	Plastic Plug 1-1/2"	1
* 10	B-6270	B-6270	B-6270	B-6270	Square Bearing	2
* 11	F-577	F-577	F-577	F-577	E-ring 5/8"	2
* 12	R-1141	R-1141	R-1141	R-1141	Spacer	1
* 13	B-3861	B-3861	B-3861	B-3861	Hitch Pin	1
* 14	D-146P	D-146P	D-146P	D-146P	Hitch Pin Cotter	1
15	B-3556-10				Handle	1
16	1M1636P				Hex Bolt 1/2" x 2-1/4"	1
17	30M1600P				Hex Nut 1/2"	1
18	40M1600P				Lock Washer 1/2"	1
19	B-2579				Grip	2
20	R-892-10	R-892-10	R-892-10	R-892-10	Clevis	2

\* - Hardware Bag

## FRONT FRAME & LIFT ASSEMBLY

Figure 1.

1. Remove Vinyl Caps over ends of Roller Drum Assembly(2). Screw Plastic Plug(9) into Threaded hole in Roller Drum Assembly(2).

NOTE: A few drops of oil on the axle during assembly will greatly improve bearing life.

2. Slide a 5/8" Washer(7) over each end of the Roller.
3. Insert one end (with installed bearing) of Scraper Bar(3) over one end of Roller Drum Assembly(2).

4. Attach other end of Scraper Bar(3) onto opposite end of Roller Drum Assembly(2).

NOTE: You will have to "spring" or "spread out" the Scraper Bar(3) in order to complete Step 4.

5. Insert Square Bearing(10) into square hole at each end of Scraper Bar(3) from inside out.

6. Slide a 5/8" Flat Washer(7) over each end of axle and use pliers to secure with a 5/8" E-Ring(11) at grooves on axle ends.

Figure 1.

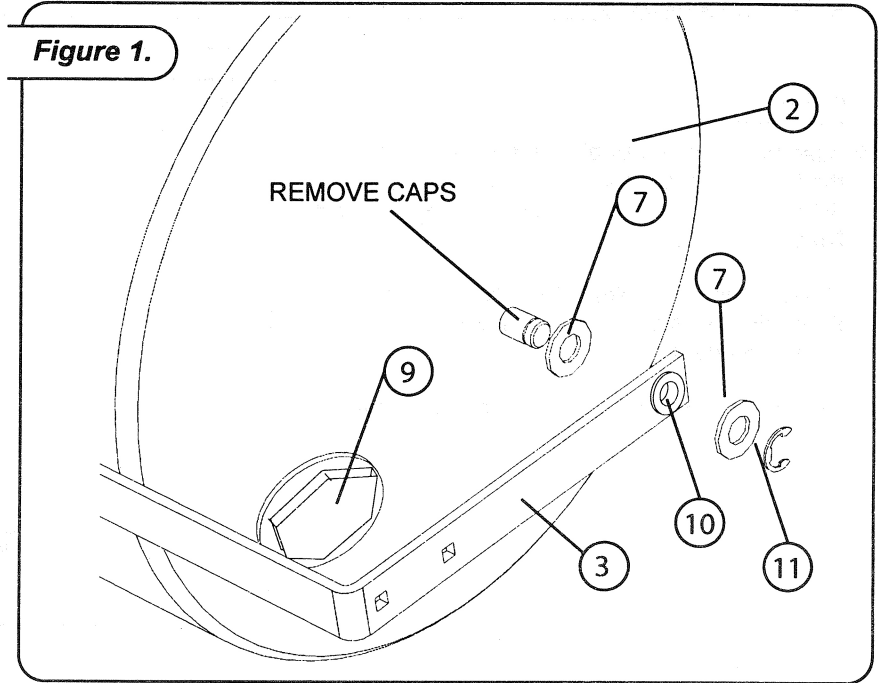

Figure 2.

7. Attach short (formed) end of each Frame Extension Bar(1) to Scraper Bar(3) securely with two 5/16" x 1" Carriage Bolts(4-from the outside), and two Nylon Lock Nuts(8) on each end. Tighten hardware securely.

Figure 2.

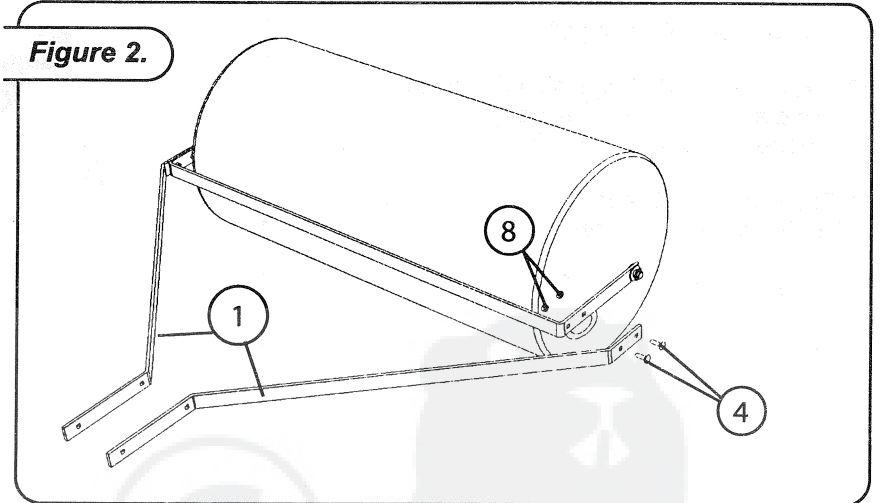
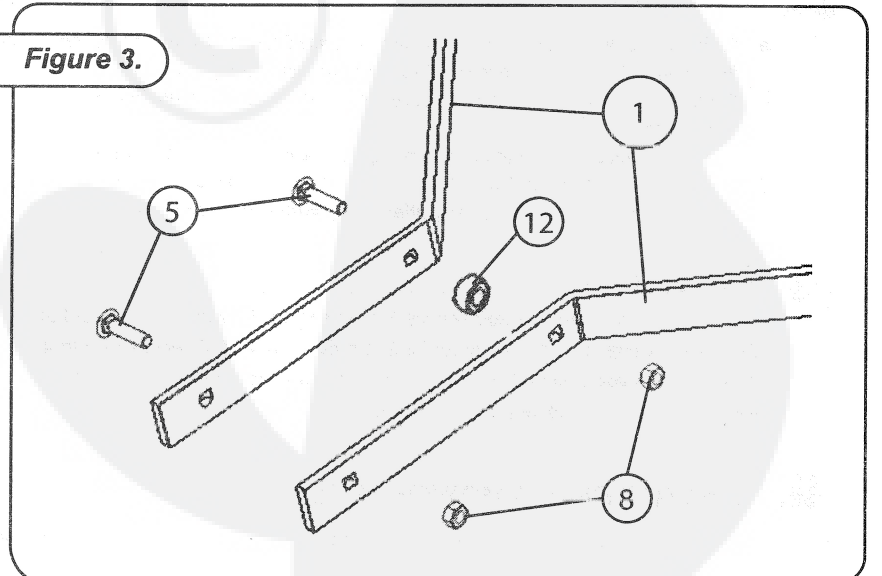

Figure 3.

8. Position Frame Spacer(12) between Frame Extension Bars(1) at rear set of holes and secure with a 5/16" x 1-1/2" Carriage Bolt(5) and Nylon Lock Nut(8). Do not tighten at this time.
9. Insert a 5/16" x 1-1/2" Carriage Bolt(5), and Nylon Lock Nut(8) through holes at front of Frame Extension Bars(1). Do not tighten at this time.

Figure 3.



## HITCH ASSEMBLY

Figure 4.

10. Assemble Clevis(20) pieces above and below the front of Frame Extension Bars using two 5/16 x 2-1/4" Carriage Bolts(6) and Nylon Lock Nuts(8).

NOTE: Carriage Bolts fit between Frame Extension Bars and between Bolts on Frame Extension Bars.

11. Pull forward on Clevis pieces and tighten all bolts securely at this time.

Figure 4.

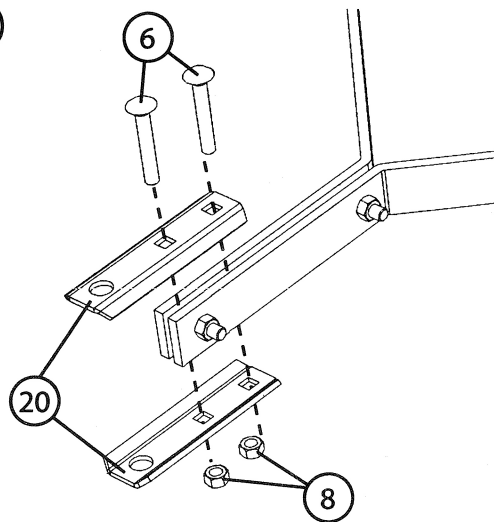
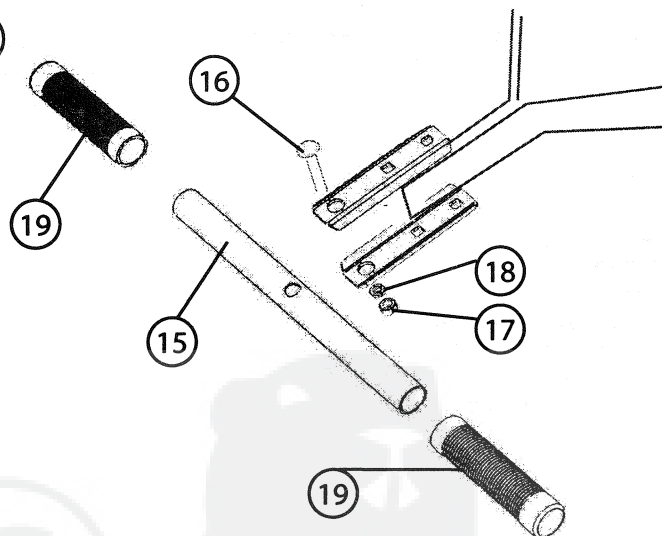

Figure 5. For PRC-241 Version only!!!

12. Loosen bolts attaching Clevis.
13. Install the Handle(15) inside Clevis opening using a 1/2" x 2-1/4" Hex Bolt(16), Lock Washer(18), and Hex Nut(17).
14. Push Handle(15) back against Frame Bars and tighten all bolts securely.
15. Slide on Rubber Grips(19).

Figure 5.



### OPERATION:

- Fill the Roller with amount of water recommended for you towing equipment. The plug(item 9) has pipe threads. Pipe threads are designed with interference in the threads to permit sealing. Tighten only the amount necessary to eliminate leaking.
- For longest life, drain the Roller and leave the Plug out when not in use. Please note that sand may be used in place of water to avoid risk of freezing.
- Ground condition is vital to good leveling. Soil should be moist, but not muddy.
- Refer to your Tractor or Riding Mower Owner's Manual for proper towing capacity and safe operation of your towing equipment. Towing/ Stopping distances will be greatly affected by added weight of roller.



### MAINTENANCE

The key to years of trouble-free service is to keep your Equipment clean and dry. Occasionally check all moving parts for free movement and, if necessary, lubricate with oil. Should rust develop, sand lightly and then paint area with enamel. Periodically check all fasteners for tightness.



### TRACTOR/RIDING MOWER SPEED

Rollers yield the best results when ground conditions are correct, and the equipment is operated at less than 3 m.p.h.

To calibrate your tractor to 3 m.p.h.:

Measure a distance of 20 feet on a flat, level surface.

Adjust tractor throttle and select a gear to cover this distance in 4.5 seconds

To adjust for 4 m.p.h., cover the same measured distance in 3.4 seconds.

# CARING FOR THE QUALITY OF YOUR LAWN

with quality products from  
**BRINLY-HARDY COMPANY**

## Our Quality Products

### Spike Aerators

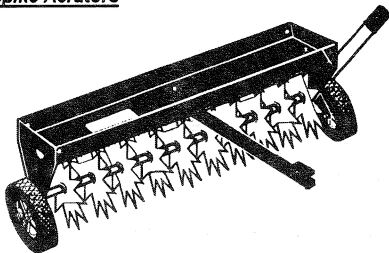

Our Spiker Aerators allow seed, fertilizer, air, and water to reach the lawn's root system, where they do the most good. This means fewer chemical applications and less frequent watering.

### Plug Aerators

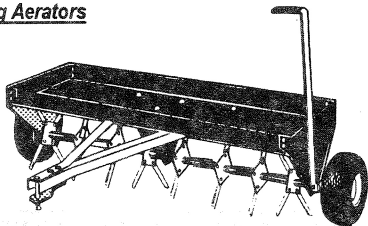

Our Plug-type Aerators are designed for the lawn care enthusiast who demands the ultimate in turf aeration! It actually pulls "plugs" of soil to relieve soil compaction and deposits them on top of the lawn where they're quickly broken down. You, too, can have a healthy looking lawn, once only affordable to golf courses!

**TO ORDER PARTS:**  
Brinly-Hardy Company  
P.O. Box 18  
Jeffersonville, IN 47131-0018  
**(877) 728-8224**

### Aerator Spreaders

You can actually handle two jobs at once with our Aerator-Spreader! This natural combination allows the 30" Aerator to perforate the soil, and the spreader immediately follows with seed, lime, or fertilizer; putting it INTO the ground so it can't be washed away!

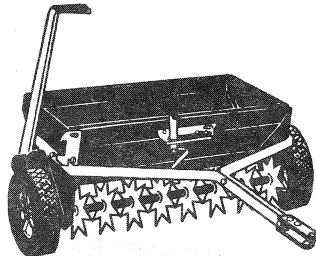

### Broadcast Spreaders

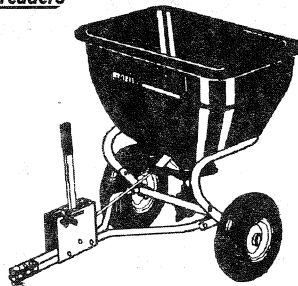

Our Brinly Spreaders handle everything from seed to ice-melters. Equipped with AutoFlow™, the material flow stops and starts when the rider does...no need to worry about "burns" or "streaks" on the lawn. Our gears are fully enclosed, so they'll last and last!

Our larger 2.5 and 3.5 cu. ft. Spreaders offer a unique, Directional Spread Pattern Control that lets you CHOOSE your spread pattern; adjust it to spread to either side or to center. Also, a clear, vinyl cover is included to protect materials from moisture.

## About the Company

For generations, Brinly-Hardy has been serving the growing needs of farmers, gardeners, lawn professionals, and homeowners. Our first plow was introduced in 1839, and ever since, we have been forging a name in the production of quality-crafted farm, lawn, turf, and garden tools. It's a proud heritage, one you can trust in caring for your lawn.

### Dethatchers

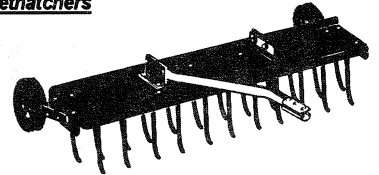

If left alone, matted layers of thatch and large grass clippings can form on your lawn which prevents air circulation and breeds disease. Our patented design Dethatcher with spring steel tines gently comb thatch and clippings to the surface where they can be re-mulched, collected, or left exposed to the elements to break down.

### Utility Carts

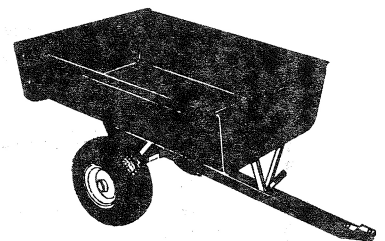

Our Dumping Utility Carts have a patented, rounded corner design which prevents soil, gravel, mulch, sand, etc. from getting trapped along the edges (where they can cause rust), and the bracketless, removable tailgate has NO obstructions to catch material when dumping. These Utility Carts are built to last with our solid steel axles, heavy steel beds, and our state-of-the-art powder coated paint finish.

CUT HERE

**BRINLY-HARDY COMPANY**  
P.O. BOX 18  
JEFFERSONVILLE, IN  
47131-0018

**(877) 728-8224**

website address: [www.brinly.com](http://www.brinly.com)  
e-mail address: [brinly@brinly.com](mailto:brinly@brinly.com)

### Sweepers

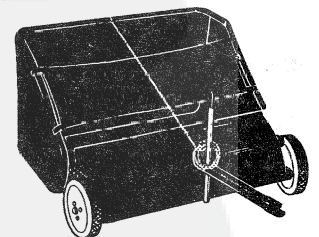

A Brinly-Hardy Sweeper is sure to make your outside chores much easier! Forget the brooms and rakes, you can quickly sweep up grass clippings, leaves, and even debris from the pavement and quickly dump them into compost bins or bags. The spring-loaded Compost Clip makes it a snap!

For even more versatility, attach our new Dethatcher Kit to either our 30" or 36" Sweeper, and tackle two jobs at once!

These sweepers are built for all seasons and will last for years and years.

**Sprayers**

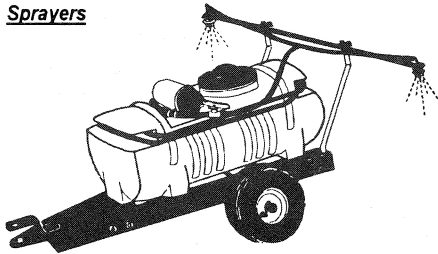

Brinly sprayers are designed to be easy to use, extremely accurate, and long lasting. Our in-line mounted tank design means that even the biggest tank is easy to maneuver and can fit through a garden gate. Each unit comes with a tractor-mounted on/off control.

**Poly Lawn Rollers**

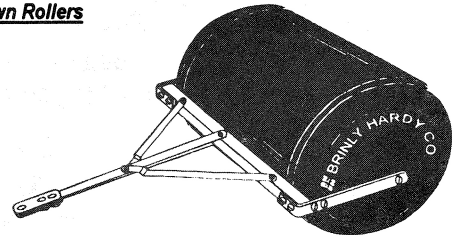

No more rust or dents with these poly lawn rollers. These units are much easier to deal with than the steel versions. They have rounded end caps that won't tear or gouge the lawn when turning. Erase the harmful effects of front heaving and moles, or pack down newly sewn seed or sod.

**Garden Tractor Attachments**

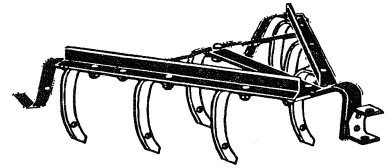
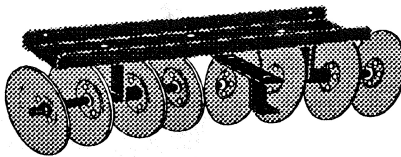
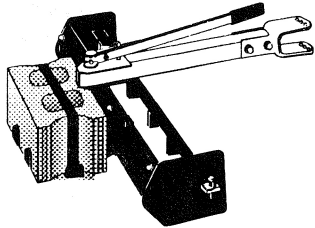

Brinly's garden tractor items offer the largest selection to turn your garden tractor into a year-round tool. We have box scrapers, blades, cultivators, disk harrows, and even a plow! Remember that a sleeve hitch is required to hook up these items to your garden tractor.

**Quality Insurance**

Dear Customer,  
We are very proud of our quality and endeavor to produce each product to meet high standards. Should your purchase not meet your expectations, we have a Quality Insurance Policy.

If you purchase a product and a part is missing or defective, please inform us of the problem on the "Comments" section of the Warranty Registration Card below. Mail the card to us, or you may call us toll free at (877) 728-8224. We will make every effort to ship a new replacement part to you within 24 hours at no charge.

Thank you,

President  
Brinly-Hardy Company

**WARRANTY REGISTRATION CARD**

To register your new product for warranty, please complete and return this card.

Name: \_\_\_\_\_ Phone: \_\_\_\_\_

Address: \_\_\_\_\_ E-mail: \_\_\_\_\_

City: \_\_\_\_\_ State: \_\_\_\_\_ Zip: \_\_\_\_\_ Country: \_\_\_\_\_

Product Purchased: \_\_\_\_\_ Model No.: \_\_\_\_\_

Packing No. (On Carton): \_\_\_\_\_

Where Purchased: \_\_\_\_\_ Date Purchased: \_\_\_\_\_

Type of Tractor/Rider Owned? Make: \_\_\_\_\_ Model: \_\_\_\_\_ HP: \_\_\_\_\_

Size of Lawn?  1/4 to 1/2 acre  1/2 to 1 acre  1 to 5 acres  over 5 acres

Do you garden?  Yes  No  Use a tractor?  Use a tiller?

Your occupation: \_\_\_\_\_

**YOUR COMMENTS WILL BE APPRECIATED:** \_\_\_\_\_

\_\_\_\_\_  
\_\_\_\_\_  
\_\_\_\_\_  
\_\_\_\_\_

**Warranty Registration Card**

Please complete the Warranty Registration Card, place in an envelope and mail to us so that we will have a record of your purchase and your comments.



Register Online at:

[www.brinly.com](http://www.brinly.com)