

shindaiwa

INSTRUCTION MANUAL

269T

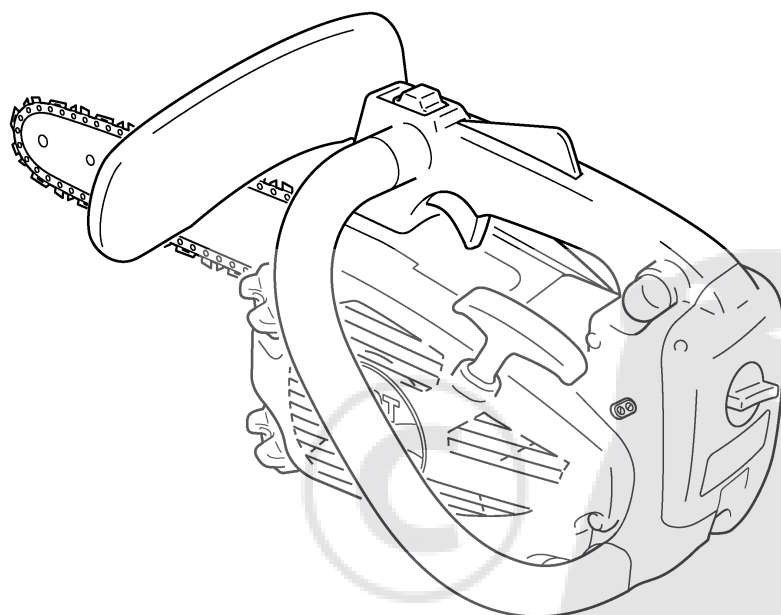

WARNING ⚠ DANGER

**THIS CHAIN SAW IS DESIGNED ESPECIALLY FOR TREE SERVICE BY A TRAINED OPERATOR.
READ INSTRUCTIONS CAREFULLY AND FOLLOW RULES FOR SAFE OPERATION.
FAILURE TO DO SO COULD RESULT IN SERIOUS INJURY.**

CE

INTRODUCTION

This manual shows rules of safe operation, proper use, servicing, and maintenance of your chain saw. Follow these instructions in order to maintain good operating condition and a long service life. Misuse of the chain saw can cause serious bodily injury. It is important for you to understand all safety precautions correctly before using your chain saw.

This chain saw is designed for cutting wood or wood products. Do not cut solid metal, sheet metal, plastic or any non-wood materials.

















If there is any clause in this Manual that is hard to be understood, please contact your shindaiwa dealer.

CONTENTS

| | | | |
|----------------------------------|----|---------------------------------|----|
| INTRODUCTION | 2 | SERVICE MAINTENANCE GUIDE | 20 |
| DECALS AND SYMBOLS | 3 | TROUBLE SHOOTING | 20 |
| RULES FOR SAFE OPERATION | 4 | SERVICE | 21 |
| DESCRIPTION | 10 | SAW CHAIN MAINTENANCE | 23 |
| ASSEMBLY | 12 | STORAGE | 24 |
| OPERATION | 12 | SPECIFICATIONS | 25 |
| CORRECT USE OF CHAIN BRAKE | 15 | DECLARATION OF CONFORMITY | 26 |
| CUTTING INSTRUCTION | 16 | | |



DECALS AND SYMBOLS

| Symbol form/shape | Symbol description/application | Symbol form/shape | Symbol description/application |
|---|---|--|--|
|  | Carefully read the operator's manual |  | Petrol and oil mixture |
|  | This symbol accompanied by the words warning and danger calls attentions to an act or a condition which can lead to serious personal injury or death. |  | Chain oil fill / oil pump |
|  | Circle and slash symbol means whatever is shown is prohibited. |  | Chain oiler adjustment |
|  | CAUTION indicates a potentially hazardous situation, if not avoided, may result in minor or moderate injury. |  | Purge bulb (Primer) |
|  | For this reason only persons trained in special cutting and working techniques may use these special chainsaws. |  | Carburettor adjustment -Low speed mixture |
|  | One handed operation of the saw can be dangerous. |  | Carburettor adjustment -High speed mixture |
|  | Wear eyes, ears and head protection |  | Carburettor adjustment -Idle speed |
|  | Warning! Kickback may occur! |  | Recommended maximum speed |
|  | Emergency stop |  | Guaranteed sound power level |
|  | Chain brake operation |  | This enclosed message provides tips for use, care and maintenance of the unit. |

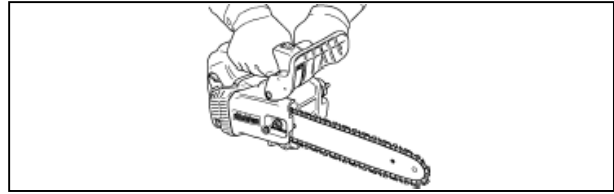

RULES FOR SAFE OPERATION

1. Tree service chain saw

- The saw is specially designed for tree service, i.e. for off-ground working in trees, and when being used as such should only be used by trained operators. One handed operation of the saw can be dangerous.
- Be alert for the phenomena “skating” and “bouncing”, greater risk from kickback. Be cautious not to lose balance of your body due to “drop” at the end of a cut.

- If working off the ground the operator must be trained in safe climbing techniques and use of all recommended safety equipment such as harness, loops, straps, ropes and karabiners for himself and for the saw.
- When hoisting a chain saw using a rope tied to a lifting hook for operation on a tree, ensure that the lifting hook is not strained by excessive force.

Note

When replacing guide bar or saw chain, ask your shindaiwa dealer.



1. GENERAL PRECAUTIONS OPERATOR'S MANUAL

- Read the operator's manual for your chain saw carefully. Be thoroughly familiar with the chain saw's controls and how to use the chain saw properly. Failure to follow instructions could lead to personal injury.
- If you have any questions or troubles, please contact shindaiwa dealer.

PHYSICAL CONDITION

- Do not operate a chain saw when you are fatigued or under the influence of alcohol or drugs.
- You should be in good physical and mental health in order to handle your chain saw safely. Do not operate when ill or fatigued, or under the influence of any substance or medication which could affect your vision, dexterity or judgement.

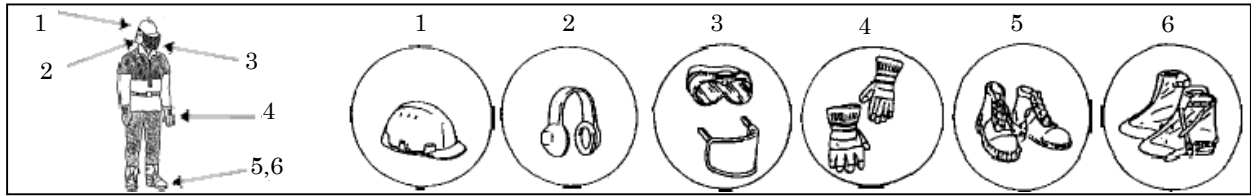

PERSONAL EQUIPMENT

- Always wear head, eye and hearing protection when operating this machine to protect yourself from wood chips, dust, snapping branches, noise and etc.

CAUTION

Stuffing ears with cotton is not recommended.

- All persons who make part of their living using chain saws should be tested periodically for hearing deterioration.
- Always wear a cap or hat when working with a chain saw. A safety hard hat is highly recommended when felling or working under trees, or when objects can fall on you.
- Wear heavy duty, non-slip gloves.
- Safety tip shoes or boots with non-slip sole should be worn.



- Never wear loose clothing, unbuttoned jackets, flared sleeves and cuffs, scarfs, tie-strings, neckties, cords, chains, jewelry, etc. which could snag the saw chain or underbrush.
- Clothing should be of sturdy, protective material. It should be snug-fitting to resist snagging, but roomy enough for freedom of movement.
- Trouser legs should not be flared or cuffed, and should be either tucked into the boot tops or trimmed short.
- Safety vests, leg chaps and logger's pants of ballistic material are available. It is the operator's responsibility to wear such additional protection if conditions warrant it.
- Never operate a chain saw when you are alone. Arrange to have someone remain within calling distance in case you need help.

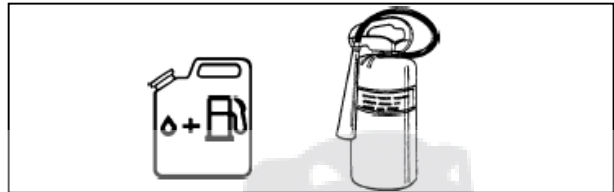

FUEL

WARNING ⚠ DANGER
PETROL AND FUEL ARE EXTREMELY FLAMMABLE. IF SPILLED OR IGNITED BY IGNITION SOURCE, IT CAN CAUSE FIRE AND SERIOUS INJURY OR PROPERTY DAMAGE. EXTREME CAUTION IS REQUIRED, WHEN HANDLING PETROL OR FUEL.

- Use an appropriate type fuel container.
- Do not smoke or bring flame or sparks near fuel supplies.
- The fuel tank may be under pressure. Always loosen the fuel cap and wait for pressure to be equalized before removing the cap.

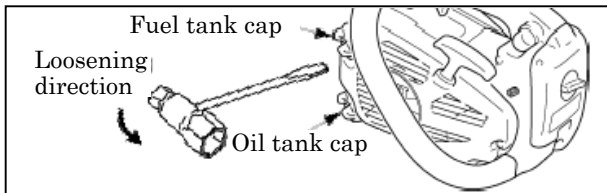

- When fuel tank cap or oil tank cap is difficult to remove by fingers, put the enclosed socket wrench into the groove of cap and turn it counterclockwise.

NOTE

Do not press socket wrench forcefully, since tank cap is plastic. Pressing forcefully can damage tank cap. If tank cap is damaged, do not start engine and ask your shindaiwa dealer for replacement.



- Fill the fuel tank outdoors over bare ground and install the fuel cap securely. Do not pour fuel indoors.
- Wipe any spilled fuel off the unit.
- Never refuel while the engine is still hot.
- Do not store the unit with fuel in its tank, because a fuel leak could start a fire.
- Bring an extinguisher or shovel in case of fire.
- After refuelling tighten fuel cap firmly and check for leakage. In case of fuel leakage repair before starting operation since there is a danger of fire.



STARTING ENGINE

- Move the chain saw at least 3 m from the fuelling point before starting the engine.
- Do not allow other persons to be near the chain saw when you are starting or cutting with the chain saw. Keep bystanders and animals out of the work area. Do not let anyone hold wood for you to cut.
- Do not start cutting until you have a clear work area, secure footing, and a planned retreat path from the falling tree.
- Before you start the engine, make sure that the saw chain is not contacting anything.
- Keep the handles dry, clean, and free of oil or fuel mixture.
- Operate the chain saw only in well-ventilated areas. Exhaust gas, oil mist (from chain saw lubrication) or dust is harmful to health.

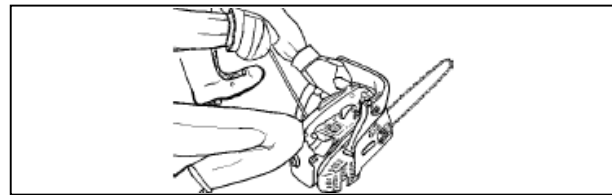

- When starting the chain saw place the unit on a flat ground and hold the front handle with left hand and hold firmly the rear end of rear handle with right knee and pull starter handle with right hand.

WARNING  **DANGER**
DO NOT DROP START THE CHAIN SAW, DROP START PUTS CHAIN SAW IN AN INSECURE POSITION AND CAN RESULT IN INJURY. START THE CHAIN SAW IN A CORRECT MANNER.

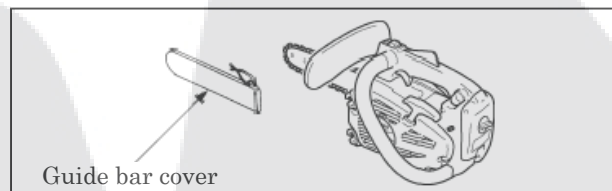

TRANSPORTATION

- When transporting your chain saw, use the appropriate guide bar cover.
- Carry the chain saw with the engine stopped, the guide bar and saw chain to the rear, and the silencer away from your body.

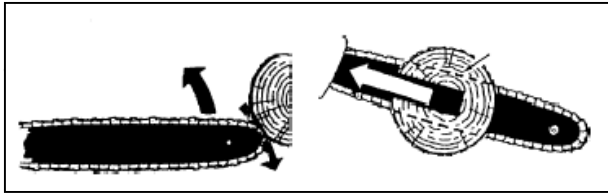

2. KICKBACK SAFETY PRECAUTIONS

WARNING  **DANGER**
KICKBACK SAFETY PRECAUTION FOR CHAIN SAW USERS KICKBACK MAY OCCUR WHEN THE NOSE OR TIP OF THE GUIDE BAR TOUCHES AN OBJECT OR WHEN THE WOOD CLOSES IN AND PINCHES THE SAW CHAIN IN THE CUT.

- Tip contact in some case may cause a lightning-fast reverse reaction, kicking the guide bar up and back toward the operator (this is called a rotational kickback).
 Pinching the saw chain along the top of the guide bar may push the guide bar rapidly back toward the operator (this is called a linear kickback).

- Either or these reactions may cause you to lose control of the saw and come in contact with the moving chain, which could result in serious personal injury. As a chain saw user, you should take several steps to keep your cutting jobs free from accident or injury.
- With a basic understanding of kickback, you can reduce or eliminate the element of surprise. Sudden surprise contributes to accidents. Understand that rotational kickback is preventable by keeping an unshielded bar nose from touching an object or the ground.

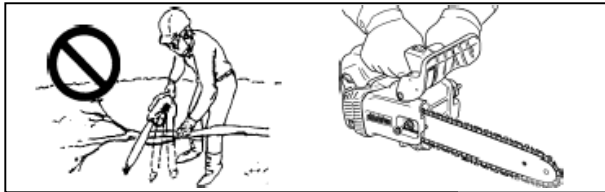

- Do not operate a chain saw with one hand! Serious injury to the operator, helpers or bystanders may result from one-handed operation. For proper control, always use two hands when operating a chain saw, one hand which operates the trigger. This can result in the chain saw “skating” or skidding, which can result in personal injury due to loss of control.
- Keep a good firm grip on the saw which both hands, with the right hand on the rear handle and the left hand on the front handle, when the engine is running. Use a firm grip with thumbs and fingers enriching the chain saw handles. A firm grip will help you reduce kickback and maintain control of the saw. Two hands must be used to control the saw at all times.

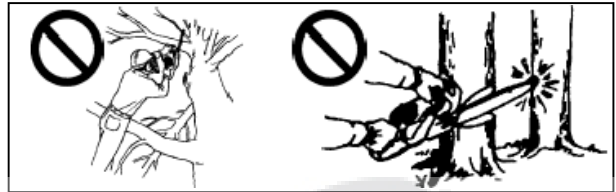

- Do not overreach or cut above chest height.
- Make sure that the area in which you are cutting is free from obstructions. Do not let the bar nose contact a log, branch, or any other obstruction which could be hit while you are operating the saw.
- Cutting at high engine speeds may reduce the likelihood of kickback. But cutting at part-throttle or low engine speeds may be preferable to control the chain saw in tight situations and may also reduce the likelihood of kickback.
- Follow manufacturer’s sharpening and maintenance instructions for the saw chain.
- Use only replacement guide bars and chains specified by the manufacturer, or the acceptable equivalents of these guide bars and chains.

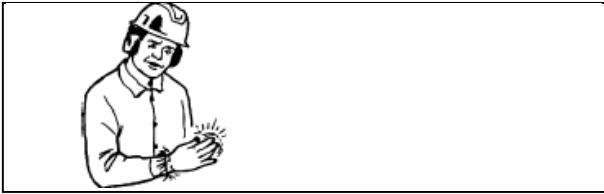

3. OTHER SAFETY PRECAUTIONS VIBRATION AND COLD

It is believed that a condition called Raynaud's Phenomenon, which affects the fingers of certain individuals, may be brought about by exposure to cold and vibration.

Accordingly, your chain saw has shock mounts designed to reduce the intensity of vibration received through the handles.

Exposure to cold and vibration may cause tingling and burning followed by loss of color and numbness in the fingers. We strongly recommend your taking the following precautions because the minimum exposure which might trigger the ailment is unknown.

- Keep your body warm, especially the head and neck, feet and ankles, and hands and wrists.
- Maintain good blood circulation by performing vigorous arm exercises during frequent work breaks and also by not smoking.
- Limit the number of hours of chain saw operation. Try to fill a part of each work day with jobs other than chain sawing.
- If you experience discomfort, redness and swelling of the fingers, followed by whitening and loss of feeling, consult your physician before further exposing yourself to cold and vibration.

MACHINE CONDITIONS

- Do not operate a chain saw that is damaged, improperly adjusted, or not completely and securely assembled.

Do not operate the chain saw with a loose or defective silencer.

Be sure that the saw chain stops moving when the throttle control trigger is released.

REPETITIVE STRESS INJURIES

It is believed that overusing the muscles and tendons of the fingers, hands, arms and shoulders may cause soreness, swelling, numbness, weakness and extreme pain to the areas just mentioned.

To reduce the risk of repetitive stress injury, do the following:

- Avoid using your wrist in a bent, extended or twisted position. Instead, try to maintain a straight wrist position. Also, when grasping, use your whole hand, not just the thumb and index finger.
- Take periodic breaks to minimize repetition and rest your hands.
- Reduce the speed and force in which you do the repetitive movement.
- Do exercises to strengthen the hand and arm muscles.
- See a doctor if you feel tingling, numbness or pain in the fingers, hands, wrists or arms.

WARNING  **DANGER**
DO NOT MODIFY A CHAIN SAW IN ANY WAY.
USE ONLY SHINDAIWA RECOMMENDED PARTS
AND ACCESSORIES WHEN REPAIRING AND
SERVICING.

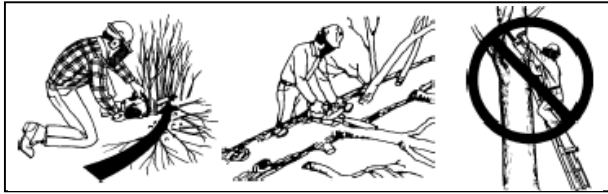

CUTTING

- Do not operate a chain saw in a tree unless you have been specifically trained to do so.
- Keep all parts of your body away from the saw chain when the engine is running.
- Use extreme caution when cutting small-size brush and saplings because slender material may catch the saw chain and be whipped toward you or pull you off balance.
- When cutting a limb that is under tension, be alert for springback so that you will not be struck by the limb or chain saw when the tension in the wood fibers is released.
- Cutting while on a ladder is extremely dangerous because the ladder can slip and your control of the chain saw is limited.
Working aloft should be left to professionals.
- Stop the engine before setting the chain saw down.

SERVICES

- All chain saw service, other than items listed in the operator's manual maintenance instruction, should be performed by competent service personnel.
(For example, if improper tool is used to hold the flywheel in order to remove the clutch, structural damage to the flywheel could occur and subsequently could cause the flywheel to burst.)



WOOD PRACTICES

- Operating a chain saw safely requires a chain saw in proper working order, sound judgement, and knowledge of the methods which should be applied in each cutting situation.
- Do not let any person use your saw unless he has read this operator's manual and fully understands its instructions.
- Never let children operate the saw.
- Use your saw only to cut wood or wood products. Do not cut solid metal, sheet metal, plastics or any non-wood materials.
- Stay on the uphill side when bucking or limbing logs which might roll when cut.
- Keep both feet on the ground. Do not work from off-the-ground positions.



CHAIN BRAKE

The chain brake's function is to stop chain rotation after a kickback. It neither prevents nor reduces kickback.

Do not depend on the chain brake for protection against kickback.

Even with a chain brake, depend on your own good sense and proper cutting methods just as though there were no chain brake.

Even with normal use and proper maintenance, the response time of the brake may lengthen.

The following may interfere with the brake's ability to protect the operator:

- Saw wrongly held too close to operator's body.
Kickback time may be too fast even for a perfectly maintained brake to work in time.
- The operator's hand may not be in position to contact the hand guard.
Brake will not be tripped.
- Lack of proper maintenance lengthens the brake's stopping time, making it less effective.
- Dirt, grease, oil, pitch, etc. getting into the working parts of the mechanism may lengthen the stopping time.
- Wear and fatigue of the activating brake spring, and wear of the brake/clutch drum and pivot points may lengthen the brake's stopping time.
- A damaged hand guard and lever may render the brake inoperative.

DESCRIPTION

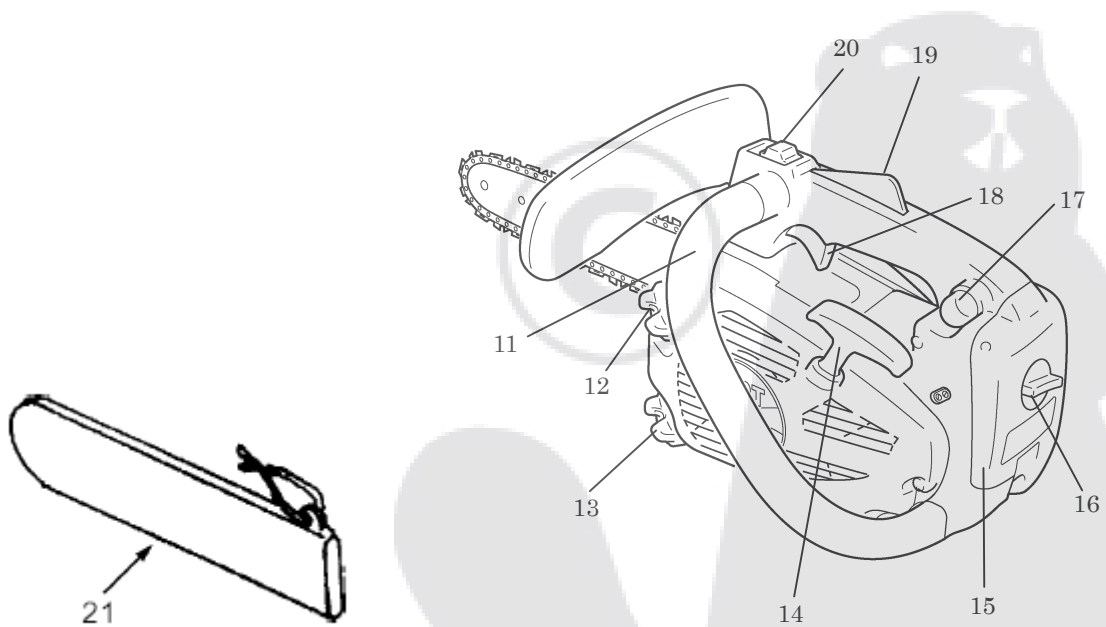
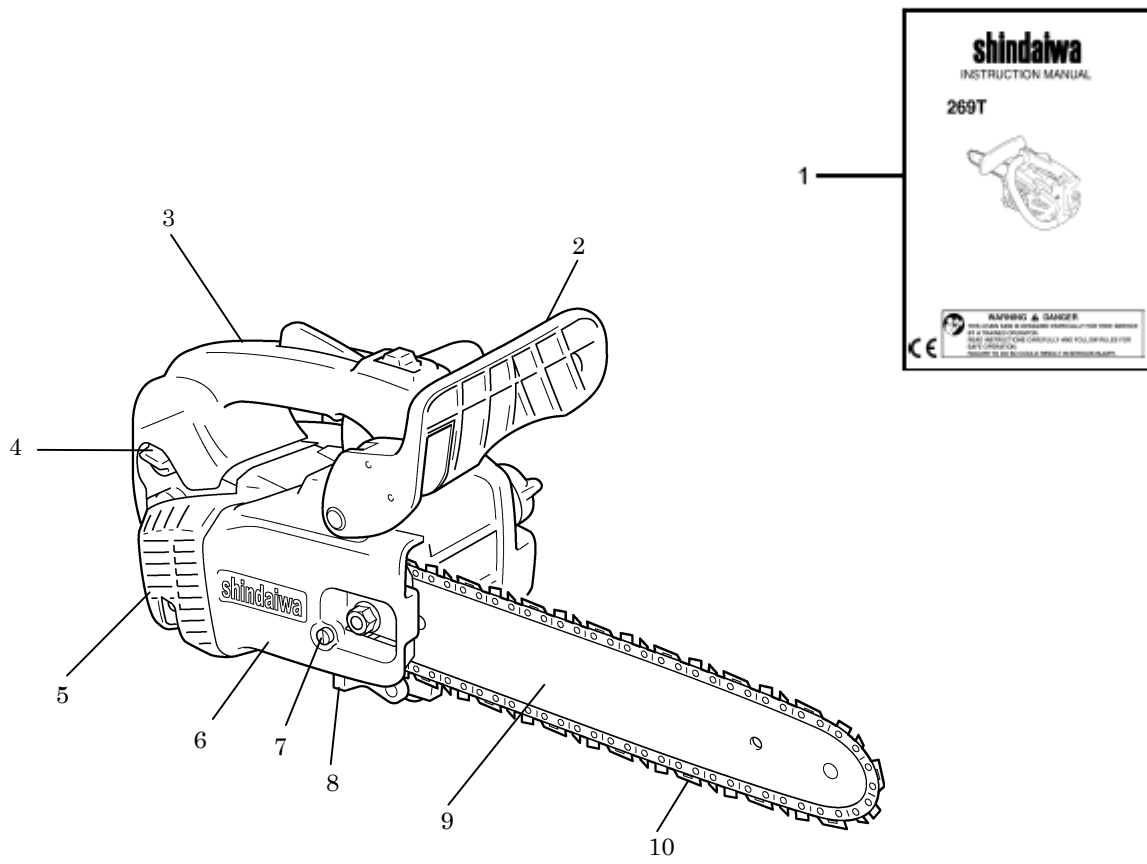

DESCRIPTION

1. **OPERATOR'S MANUAL** - Included with unit. Read before operation and keep for future reference to learn proper, safe operating techniques.
2. **FRONT HAND GUARD** - Guard between the front handle and the saw chain for protecting the hand from injuries and aiding in control of the chain saw if the hand slips off the handle. This guard is used to activate the chain brake which is to stop the saw chain rotation.
3. **REAR HANDLE (FOR THE RIGHT HAND)** - Support handle located towards the rear of the engine housing.
4. **CHOKE CONTROL KNOB** - Device for enriching the fuel/air mixture in the carburettor to aid cold starting.
5. **SILENCER COVER** Cover the silencer not to make operator touch to hot surface of silencer.
6. **CLUTCH COVER** - Protective cover to the guide bar, saw chain, clutch and sprocket when the chain saw in use.
7. **CHAIN TENSION ADJUSTER** - This is device to adjust chain tension.
8. **CHAIN CATCHER** - A projection designed to reduce the risk of the operator's right hand from being hit by a chain which has broken or derailed from the guide bar during cutting.
9. **GUIDE BAR** - The part that supports and guide the saw chain.
10. **CHAIN** - Chain, serving as a cutting tool.
11. **FRONT HANDLE (FOR THE LEFT HAND)** - Support handle located at the front of the engine housing.
12. **FUEL TANK CAP** - For closing the fuel tank. Turn cap clockwise to tighten. Tighten it firmly with hand.
13. **OIL TANK CAP** - For closing the oil tank. Turn cap clockwise to tighten. Tighten it firmly with hand.
14. **STARTER HANDLE** - The grip of the starter, for starting the engine.
15. **AIR CLEANER COVER** - Covers air filter.
16. **CLEANER COVER KNOB** - Device for installing the air cleaner cover. Turn cleaner cover knob clockwise to tighten. Tighten it firmly with hand.
17. **PRIMER PUMP** - When starting engine, push primer pump 3 or 4 times.
18. **THROTTLE TRIGGER** - Device activated by the operator's finger, for controlling the engine speed.
19. **THROTTLE TRIGGER LOCKOUT** - A safety lever which must be depressed before the throttle trigger can be activated in order to prevents the accidental operation of the throttle trigger.
20. **IGNITION SWITCH** - Device for connecting and disconnecting the ignition system and thus allowing the engine to be started or stopped.
21. **GUIDE BAR COVER** - Remove device for covering the guide bar and saw chain during transport and other times when the chain saw is not in use.



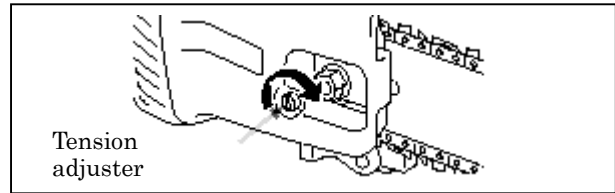
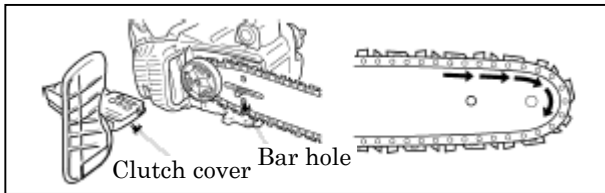

ASSEMBLY

MOUNTING GUIDE BAR AND CHAIN

The unit is delivered with guide bar and saw chain separated. Install guide bar and chain as follows.

WARNING  **DANGER**
FOR YOUR OWN SAFETY, ALWAYS STOP THE ENGINE BEFORE PERFORMING ANY OF THE FOLLOWING OPERATIONS.

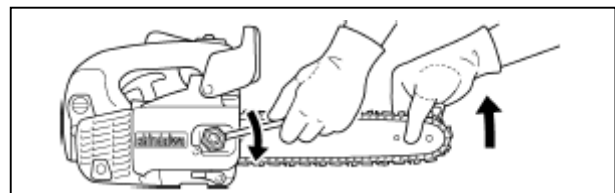
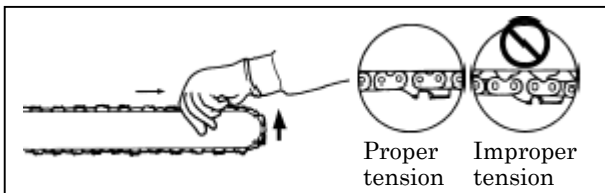

- Hold the bar nose up and turn the adjuster clockwise until the chain fits snugly against the underside of the bar.

- Unscrew a nut and remove clutch cover.
- Mount bar and slide toward clutch to make saw chain installation easier.
- Install saw chain as shown. (Ensure cutters are pointing in the right direction)
- Install the clutch cover tighten nut finger tight. Ensure that chain tension adjuster fits into bar hole.

- Tighten a nut with the bar nose held up.
- Pull the chain around the bar by hand. Loosen the adjustment if you feel tight spots.
- Start the engine and run at low speed. Stop and readjust if necessary.

CAUTION

1. All adjustments should be made when engine is cold.
2. Always wear gloves when working on chain.
3. Do not operate with a loose chain.

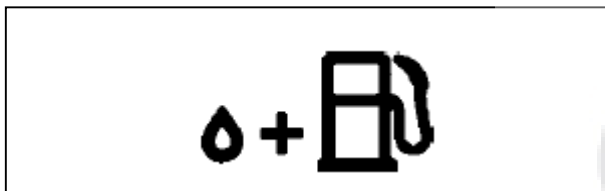

OPERATION

FUEL AND LUBRICANT

- Fuel is a mixture of regular grade petrol and an air-cooled 2-stroke engine oil of reputable brand name. Minimum 89 Octane unleaded petrol is recommended. Do not use fuel containing methyl alcohol or more than 10 % of ethyl alcohol.
- Recommended mixture ratio: 25 : 1 for JASO FA or FB grade oil.
 - Do not mix directly in fuel tank.
 - Avoid spilling petrol and oil. Spilled fuel should always be wiped up.
 - Handle petrol with care, it is highly inflammable.
 - Always store fuel in approved container.

CAUTION

Whenever opening up the fuel tank, always loosen the cap very slowly and wait for the tank pressure to be equalized before removing the cap.

CHAIN LUBRICANT

Proper lubrication of the chain while in operation reduces the friction between the chain and the guide bar to a minimum and assure a longer life time. Use only special chain oil of high quality for this purpose. Do not use any waste or reclaimed oil to avoid various problems with the oil pump. In case of emergency it is allowed to use motor oil for a short time.
 SAE 30...in summer
 SAE 10...in winter or for the cutting of wood with many resin.

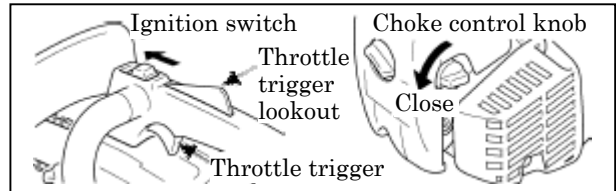
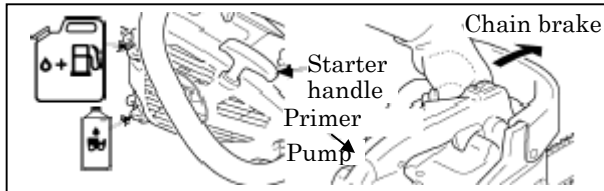

STARTING THE COLD ENGINE

- Fill the fuel tank with fuel.
- Fill the chain oil tank with lubricant.
- Press hand guard forward. (Chain brake ACTIVATED position)
- Place ignition switch in START position.
- Push primer pump until fuel is visible in primer pump.
- Turn choke control knob counterclockwise (close).

WARNING  DANGER

- AFTER CHOKE CONTROL KNOB IS TURNED AND THEN KNOB IS RETURNED TO ORIGINAL POSITION, THROTTLE REMAINS A LITTLE OPEN (LATCH CONDITION).
- IF ENGINE IS STARTED IN THIS LATCH CONDITION, CHAIN STARTS TO TURN. DO NOT START ENGINE BEFORE CHAIN BRAKE IS ACTIVATED.

NOTE

Do not pull starter rope out to the maximum position. Do not allow starter handle to snap back against the casing.

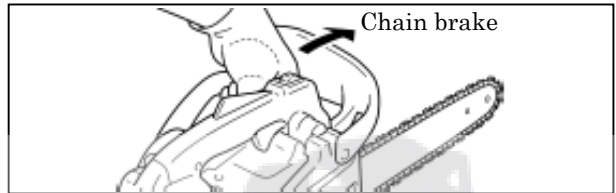
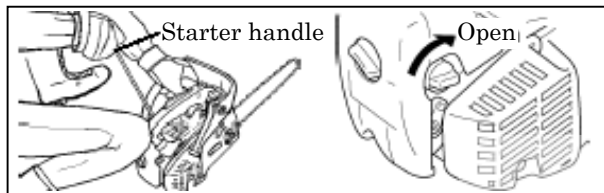

- Securely hold the chain saw. When starting the chain saw place the unit on a flat ground and hold the front handle with left hand and hold firmly the rear end of rear handle with right knee and pull starter handle with right hand.
- Make sure guide bar and saw chain are not touching anything when starting the saw.
- Pull starter handle several times until first firing sound is heard.
- Turn choke control knob clockwise (open).
- Pull starter handle again.

STARTING THE WARM ENGINE

- Press hand guard forward. (Chain brake ACTIVATED position)
- Place ignition switch in START position.
- Securely hold the chain saw.
- Pull starter handle.
- Choke may be used if necessary but after first firing sound, pull throttle trigger a little to release throttle latch and choke. After choke control knob is turned and then knob is returned to original position, throttle remains a little open (latch condition).

CAUTION

Clutch engages and chain will rotate when engine is started with throttle trigger squeezed. After engine starts release throttle trigger to idle position.

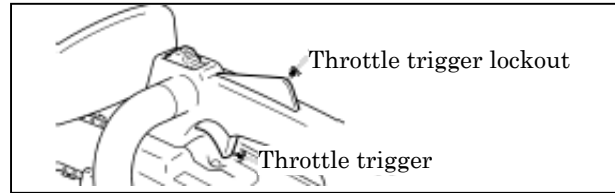
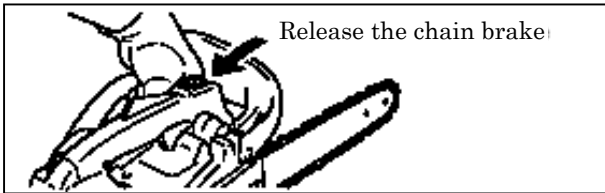

CAUTION

1. After starting the engine, squeeze throttle trigger slightly to release throttle latch and pull front hand guard towards the operator immediately. (Chain brake RELEASED position)
2. Do not increase engine speed while chain brake is engaged.
3. Use the chain brake in an emergency. Do not use it unless absolutely necessary.

CAUTION

When throttle latch is used, saw chain will go into motion as soon as the engine starts. Never use throttle latch for cutting. Use it only when starting the engine.

RUNNING

- After engine starts, allow it to idle for a few minutes.
- Squeeze throttle trigger gradually to increase engine revolution.
- The chain starts moving when the engine reaches 4,500 r/min approximately.
- Ensure proper acceleration and lubrication of saw chain and guide bar.
- Do not run the engine at high speed unnecessarily.
- Be sure that saw chain stops moving when throttle trigger is released.

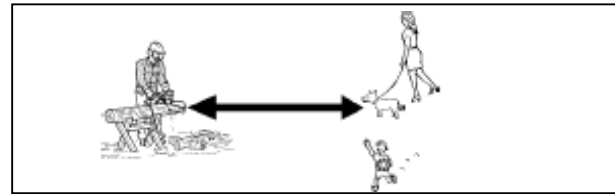
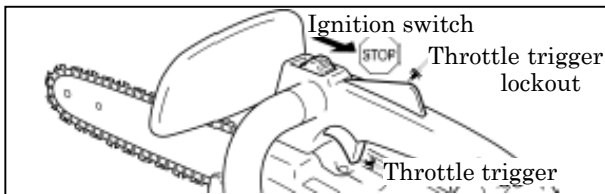

STOPPING THE ENGINE

- Release throttle trigger and allow engine to idle.
- Place ignition switch in STOP position.

NOTE

When engine does not stop, turn choke control knob counterclockwise to stop engine. Check and repair ignition switch before starting the engine again.

PRE CUTTING TEST

- Familiarize yourself with your chain saw before you start actual cutting.
- For this purpose it may be wise to practice by cutting some small logs or limbs several times.
- Do not allow anybody and animal into the work area. Multiple operators - Keep a safe distance between two or more operators when working together simultaneously.

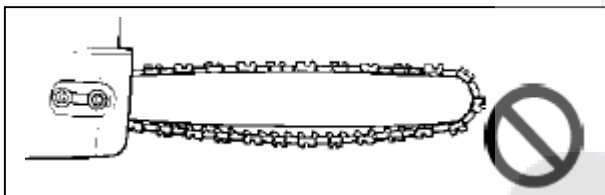

CHECKING CHAIN TENSION

- Chain tension should be checked frequently during work and corrected if necessary.
- Tension the chain as tight as possible, but so it can still be pulled easily along the bar by hand.

CHAIN LUBRICATION TEST

Hold the chain just above a dry surface and open the throttle to half speed for 30 seconds. A thin line of "thrown" oil should be seen on the dry surface.

WARNING  **DANGER**
MAKE SURE THAT THE ENGINE IS SHUT OFF WHEN CHECKING CHAIN TENSION.

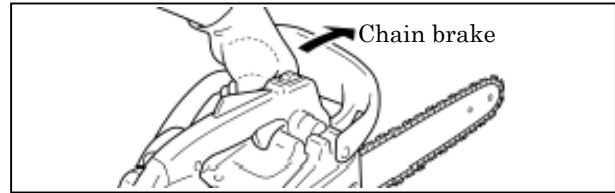
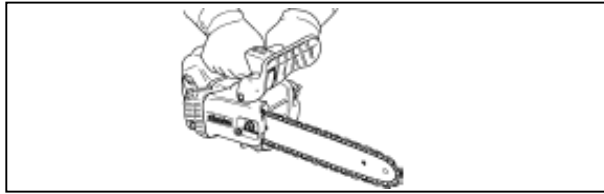

CORRECT USE OF CHAIN BRAKE

CHECKING THE BRAKE FUNCTION OF THE BRAKE

- 1) Place the chain saw on the ground.
- 2) Hold the handle with both hands and accelerate the engine to high speed by throttle trigger.
- 3) Operate the chain brake by turning your left wrist against the front hand guard during your grip on the front handle.
- 4) The chain stop immediately.
- 5) Release the throttle trigger.

RELEASE THE CHAIN BRAKE

- When front hand guard is fully pulled towards the operator, chain brake is released.
- If the chain does not stop immediately, bring the saw to your shindaiwa dealer to repair.

WARNING DANGER
MOST HAZARDOUS IS THE KICKBACK MOTION OF THE GUIDE BAR SUCH THAT, IN AN INSTANT THE TIP OF THE BAR TOUCHES A WOOD OR THE LIKE.
CHAIN BRAKE REDUCES THE POSSIBILITY OF INJURY DUE TO KICKBACK.
YOU ALWAYS CHECK THAT CHAIN BRAKE WORKS PROPERLY BEFORE USE.

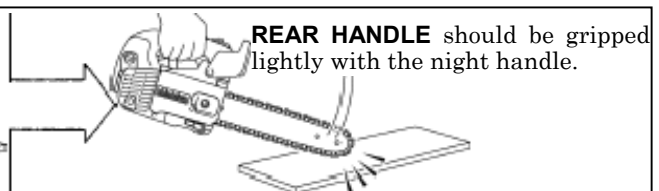
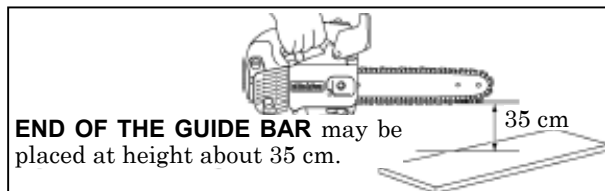

NON-MANUAL CHAIN BRAKE

The non-manual chain brake stops the operation of the saw chain in such a manner that kickback action produced at the end of the guide bar non-manually actuates the chain brake.

To make sure that the non-manual chain brake operates properly, proceed as follows:

- 1) **Stop the engine of the chain saw.**
- 2) Operate the front and rear handles with hands (grip them lightly), so that the guide bar may be placed at the height of about 35 cm as shown in Fig.

- 3) Softly detach the left hand from the front handle, and touch the end of the guide bar against the wood or the like placed below so that the machine receives an impact.
 (* at this time the rear handle should be gripped lightly with right hand).
- 4) The impact is propagated to the brake lever, which actuates the chain brake.

(PRECAUTION)

When checking the operation of the non-manual chain brake, use a soft surface substance like wood to provide the impact so the saw chain is not damaged.

NOTE

- For practice, while cutting a small tree, push the front guard forward to engage the brake.
- At all times, confirm whether the brake works properly before each work.
- If the chain brake is clogged with wood chips, function of the brake deteriorates a little. Always keep the device clean.
- Do not increase engine revolution while the chain brake is engaged.
- Chain brake is used in emergencies. Do not use it unless absolutely necessary.
- When using throttle latch at starting, keep the chain brake position. And after starting the engine, release the brake immediately.
- Never test the brake in an area where petrol fumes are present.



CUTTING INSTRUCTION

GENERAL

In all circumstances the operation of the chain saw is a one-man job.

It is difficult at times to take care for your own safety, so don't assume the responsibility for a helper as well. After you have learned the basic techniques of using the saw, your best aid will be your own good common sense.

The accepted way to hold the saw is to stand to the left of the saw with your left hand on the front handle so you can operate the throttle trigger with your right index finger.

Before attempting to fell a tree, cut some small logs or limbs.

Start the engine, see that it is running properly. Squeeze the trigger to open the throttle wide open, then start the cut. It is not necessary to press down hard to make the saw cut. If the chain is properly sharpened, the cutting should be relatively effortless. Pushing the saw too hard will slow the engine and cutting will actually be more difficult.

Some material may adversely affect the housing of your chain saw.

(Example: palm tree acid, fertilizer etc.)

To avoid housing deterioration carefully remove all packed saw dust around clutch and guide bar area and wash with water.

WARNING  DANGER
DO NOT LET THE NOSE OR TIP OF THE GUIDE BAR TOUCH ANYTHING WHILE ENGINE IS RUNNING TO AVOID KICKBACK.

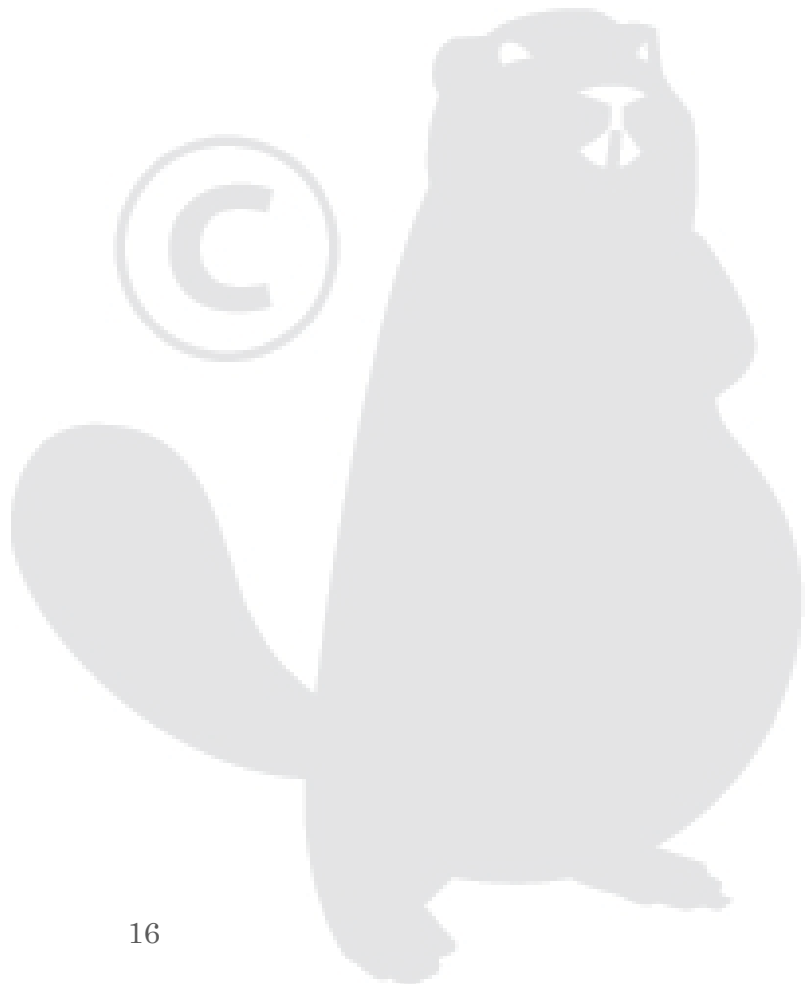

FELLING A TREE

A falling tree can seriously damage anything it may hit a car, a house, a fence a powerline or another tree. There are ways to make a tree fall where you want it, so first decide where that is!

Before cutting, clear the area around the tree. You will need good footing while working and you should be able to work the saw without hitting any obstacles. Next select a path of retreat.

When the tree begins to fall you should retreat away from the direction of fall at a 45-degree angle to avoid the trunk kicking back over the stump. (See right above figure)

Begin the cut on the side to which the tree is to fall.

Cut a notch approximately 1/3 of the way into the tree. (See figure A)

The position of this notch is important since the tree will try to fall "into" the notch. (See figure A)

The felling cut is made on the side opposite the notch.

Make the felling cut placing spiked bumper 2.5 cm to 5 cm above the bottom of the notch and stop cutting at approximately 1/10 of diameter to the inner edge of the notch (See figure B) in order to leave the uncut portion of the wood as a hinge.

Do not try to cut through to the notch with the felling cut.

The remaining wood between the notch cut and felling cut will act as a hinge when the tree falls, guiding it in the desired direction.

When the tree starts to fall, kill the engine, place the saw on the ground and make your retreat quickly.

To fell big trees with a diameter exceeding twice the bar length start the notching cuts from one side and draw the saw through to the other side of the notch.

Start the back cut on one side of the tree with spiked bumper engaged, pivoting the saw through to form the desired hinge on that side.

Then remove the saw for the second cut.

Insert the saw in the first cut very carefully so as not to cause kickback.

The final cut is made by drawing the saw forward in the cut to reach the hinge. (See figure C)

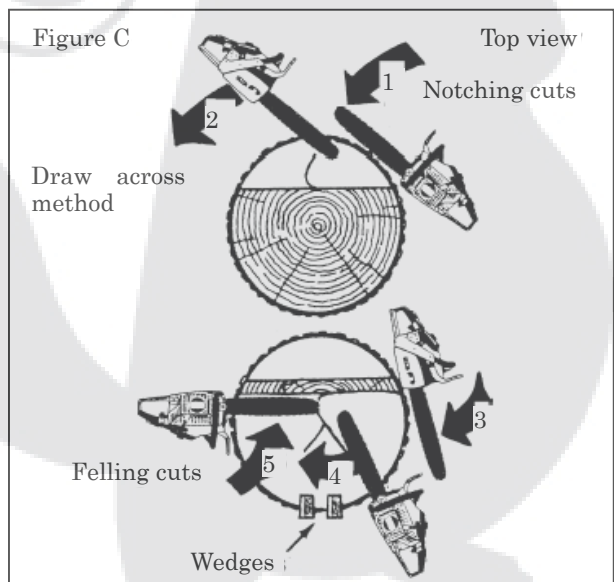
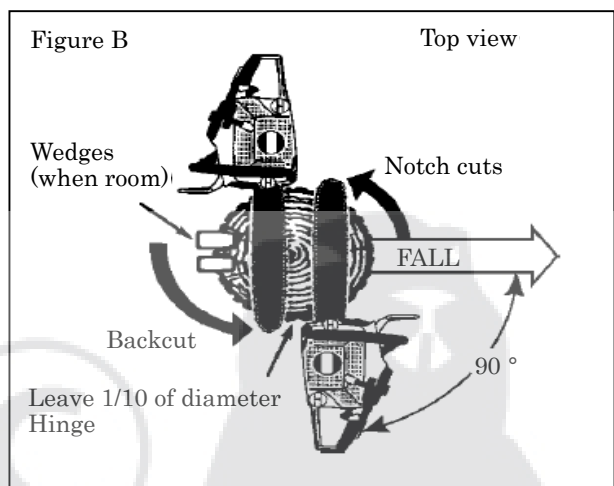
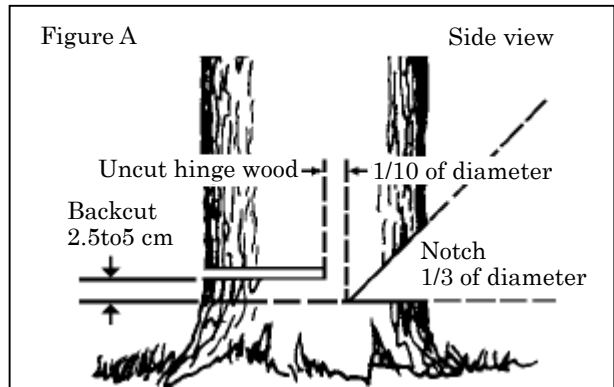
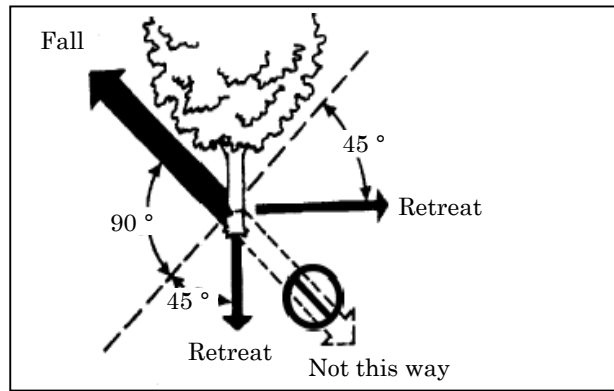

LIMBING

Limbing a fallen tree is much the same as bucking.

Never limb on the tree that you are standing.

Be careful of the tip touching other limbs.

Always use both hands.

Don't cut with the saw overhead or the bar in a vertical position. If the saw should kickback, you may not have good enough control to prevent possible injury.

CAUTION

Don't saw above chest height.

Even when limbing, use of the spiked bumper makes it easy to control the chain saw and lessens kickback.

WARNING DANGER

LIMBING IN THE PROXIMITY OF POWER LINE CAN RESULT IN ELECTROCUTION. ALWAYS SWITCH OFF POWER SUPPLY BEFORE STARTING OPERATION.

BUCKING

Bucking is the sawing of a log or fallen tree into smaller pieces.

There are a few basic rules which apply to all bucking operations.

Keep both hands on the handles at all times.

Support logs if possible.

When cutting on a slope or hillside, always stand uphill.

CAUTION

Stay on the uphill side of logs.

Do not cut above chest height



Know how limb is stressed

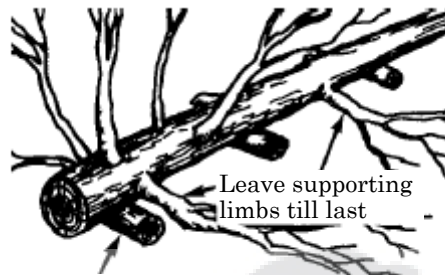

Slide support logs under trunk

No standing on log



Stay on the uphill side of logs



Down



TENSION AND COMPRESSION IN TIMBER

A length of timber lying on the ground will be subject to tension and compression depending at which points the major support is.

When timber is supported at its ends the compression side is at the top and the tension side is at the bottom. To cut between these support points make the first cut downwards approximately 1/3rd the timber diameter.

The second cut is made upwards and should meet the first cut.

When the timber is supported at one end only make the first cut upwards approximately 1/3rd the timber diameter. The second cut is made downwards and should meet the first cut.

CAUTION

If you have misjudged the effects of tension and compression, and cut from the wrong side, the timber will pinch the guide bar and chain, trapping it.

Racing the engine with the chain jammed will burn out your clutch.

If the chain should become jammed and the saw can not be removed from the cut do not force it out.

Stop the saw, force a wedge into the cut to open it up.

Never force the saw when it is jammed.

Do not force the saw into the cut.

A dull chain is unsafe and will cause excessive wear to the cutting attachments.

A good way to tell when the chain is dull is when fine saw dust comes out instead of chips.

CAUTION

Do not touch hot surfaces of cylinder cover and silencer, after you used the chain saw.

WARNING  **DANGER**
NEVER USE THROTTLE LATCH FOR CUTTING JOB.

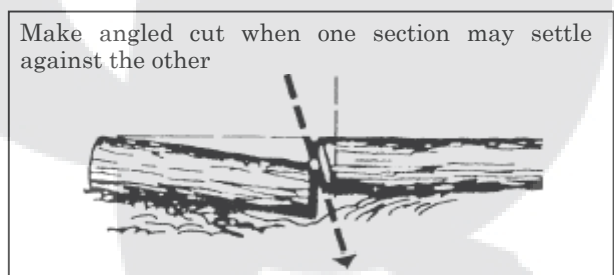
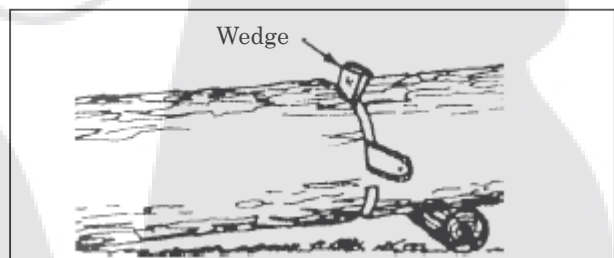
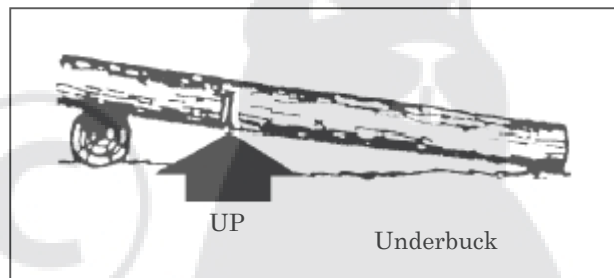
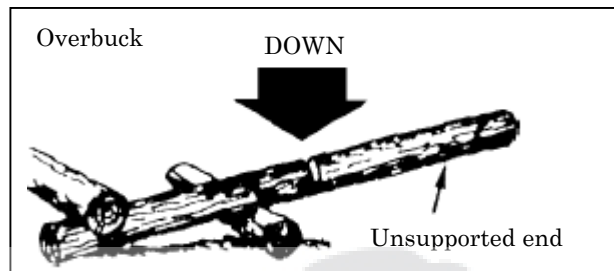
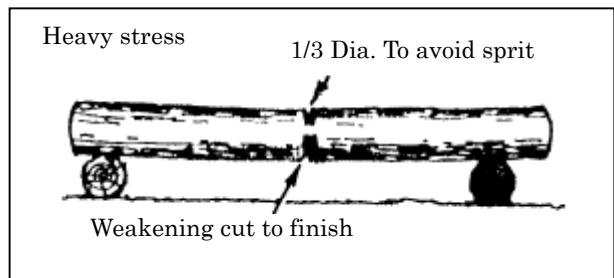
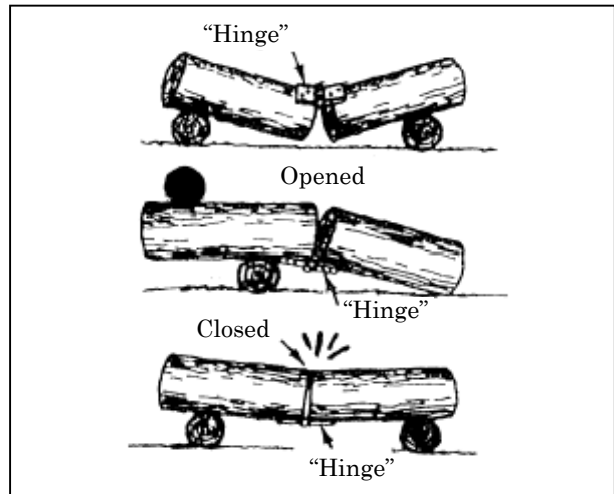

SERVICE MAINTENANCE GUIDE

| AREA | MAINTENANCE | PAGE | BEFORE USE | MONTHLY |
|------------------------|------------------------------|------|------------|---------|
| Air Filter | Clean/Replace | 21 | • | |
| Fuel Filte | Inspect/Clean/Replace | 21 | • | |
| Spark Plug | Inspect/Clean/Adjust/Replace | 22 | | • |
| Carburettor | Adjust/Replace and adjust | 21 | | • |
| Cooling System | Inspect/Clean | 22 | • | |
| Silencer | Inspect/Tighten/Clean | - | • | |
| Oil Filter | Inspect/Clean/Replace | 21 | • | |
| Sprocket | Inspect/Replace | 22 | | • |
| Chain Brake | Inspect/Replace | 15 | • | |
| Starter Rope | Inspect | - | | • |
| Guide Bar | Inspect/Clean | 22 | • | |
| Fuel System | Inspect/Repair | 6 | • | |
| Screws, Bolts and Nuts | Inspect, Tighten/Replace | - | • | |

IMPORTANT

Time intervals shown are maximum. Actual use and your experience will determine the frequency of required maintenance.

TROUBLE SHOOTING

| Trouble | | Cause | Remedy |
|-----------------------|--|--|---|
| Engine | - starts hard - does not start | | |
| Engine cranks | Fuel at carburettor → No fuel at carburettor | <ul style="list-style-type: none"> • Fuel filter clogged • Fuel line clogged • Carburettor | <ul style="list-style-type: none"> • Clean or replace • Clean • Ask your shindaiwa dealer |
| | ↓ Fuel at cylinder → No fuel at cylinder | <ul style="list-style-type: none"> • Carburettor | <ul style="list-style-type: none"> • Ask your shindaiwa dealer |
| | ↓ → Silencer wet with fuel | <ul style="list-style-type: none"> • Fuel mixture is too rich | <ul style="list-style-type: none"> • Open choke • Clean/replace air filter • Adjust carburettor • Ask your shindaiwa dealer |
| | Spark at end of plug wire → No spark at end of plug wire | <ul style="list-style-type: none"> • Ignition switch off • Electrical problem | <ul style="list-style-type: none"> • Turn switch on • Ask your shindaiwa dealer |
| | ↓ Spark at plug → No spark at plug | <ul style="list-style-type: none"> • Spark gap incorrect • Covered with carbon • Fouled with fuel • Spark plug defective | <ul style="list-style-type: none"> • Adjust 0.6 to 0.7 mm • Clean or replace • Clean or replace • Replace plug |
| Engine does not crank | ↓ | <ul style="list-style-type: none"> • Internal engine problem | <ul style="list-style-type: none"> • Ask your shindaiwa dealer |
| Engine runs | Dies or accelerates poorly | <ul style="list-style-type: none"> • Air filter dirty • Fuel filter dirty • Fuel vent plugged • Spark plug • Carburettor • Cooling system plugged • Exhaust port/silencer plugged | <ul style="list-style-type: none"> • Clean or replace • Clean or replace • Clean • Clean and adjust/replace • Adjust • Clean • Clean |

WARNING DANGER

ALL CHAIN SAW SERVICE, OTHER THAN ITEMS LISTED IN THE OPERATOR'S MANUAL SHOULD BE PERFORMED BY COMPETENT SERVICE PERSONNEL.

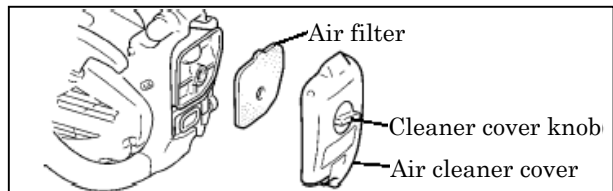
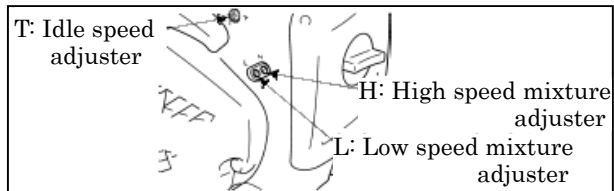

SERVICE

- If you have any questions or troubles, please contact shindaiwa dealer.

CARBURETTOR

- Do not adjust the carburettor unless necessary.
- To adjust the carburettor proceed as follows:
 - Low speed mixture adjuster (L): 1 to 1 and 1/4 turns open
 - High speed mixture adjuster (H): 1 to 1 and 1/4 turns open
 - Screw in the needles until lightly seated and return indicated turn above.
- Turn idle speed adjuster (T) clockwise until chain begins to rotate. Then back screw 1/2 turn.

CAUTION

When starting, idle speed adjuster (T) should be adjusted not to rotate the saw chain.
When there is some trouble with the carburettor, contact your distributor or dealer.

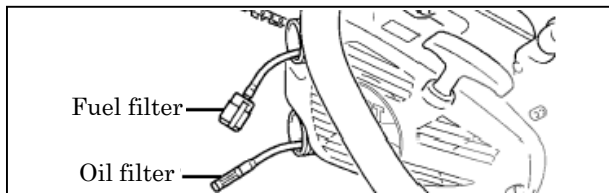

FUEL FILTER

- Check periodically.
 - Do not allow dust to enter fuel tank.
 - Clogged filter will cause difficulty in starting engine or abnormalities in engine performance.
 - Pick up the fuel filter through fuel inlet port with a piece of steel wire or the like.
 - When the filter is dirty, replace it.
 - When the inside of the fuel tank is dirty, it can be cleaned by rinsing the tank out with petrol.

WARNING  **DANGER**
PETROL AND FUEL ARE EXTREMELY FLAMMABLE.
EXTREME CAUTION IS REQUIRED, WHEN HANDLING PETROL OR FUEL.

AIR FILTER

- Check before every use.
- Loosen cleaner cover knob and remove air cleaner cover and filter.
 - Brush off dust lightly, or clean with compressed air, or replace the air filter.
- Reinstall filter and cover.

OIL FILTER

- Check periodically.
 - Do not allow dust to enter oil tank.
 - Clogged oil filter will affect the normal lubricating system.
 - Pick it up through oil filling hole with a piece of steel wire or the like.
 - If the filter is dirty, wash it in petrol or replace it.
 - When the inside of the oil tank gets dirty, it can be cleaned by rinsing the tank out with petrol.

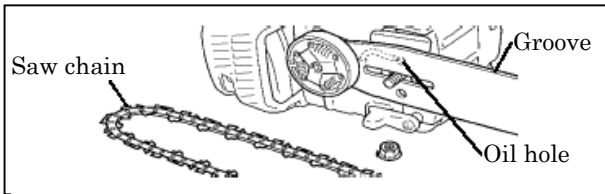

GUIDE BAR

- Clean before using.
 - Clean the groove of the guide bar with for example a small screw driver.
 - Clean oil holes with a wire.
- Reverse guide bar periodically.
- Clean sprocket, clutch and bar mount area before installation of guide bar.

NOTE

When replacing guide bar or saw chain, ask your shindaiwa dealer.

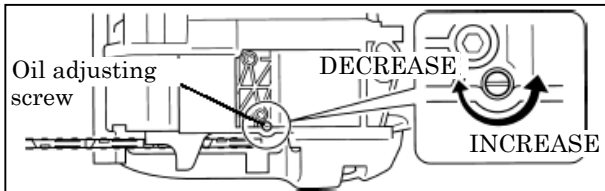

AUTOMATIC OILER

- The discharge volume of the automatic oiler is adjusted to 7 mL/min approximately at 7,000 r/min, prior to shipment from factory.
 - To increase the deliverly volume, turn the adjusting screw counterclockwise. When the adjusting screw touches stopper and stops, this position indicates maximum discharge volume. (13 mL/min 7,000 r/min)
 - Do not turn the adjusting screw beyond the max. or min. limit of volume adjustment.

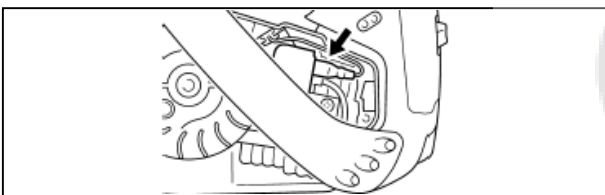

MAGNETO

- The unit has CDI (Capacitor Discharge Ignition) system, which does not require adjustment of ignition timing.
- Check for secure (tight) wire connections.

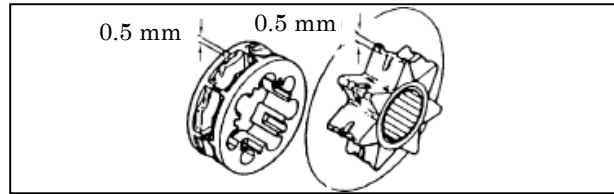

SPROCKET

- The damaged sprocket will cause premature damage or wear of saw chain.
 - When the sprocket has worn out 0.5 mm or more, eplace it.
- Check sprocket when you install new chain. Replace it if worn.

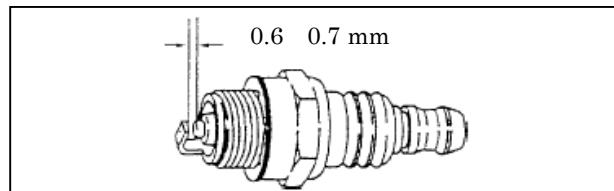

SPARK PLUG

- Check periodically.
 - The standard spark gap is 0.6 to 0.7 mm.
 - Correct the spark gap if it is wider or narrower than the standard gap.
- Fastening torque: 15 to 17 N·m (150 to 170 kgf·cm)

CYLINDER FINS

- Check periodically.
- Clogged fins will result in poor engine cooling.
 - Remove dirt and dust from between fins to let cooling air pass easily.

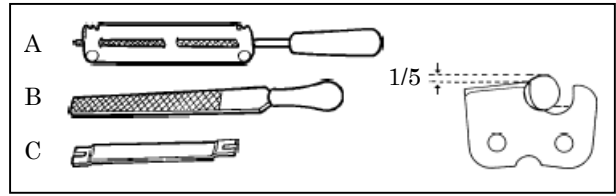
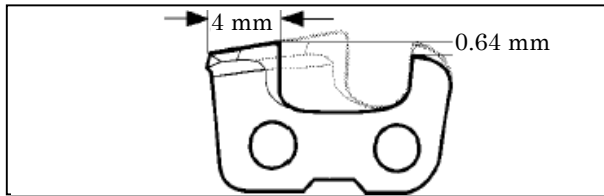

SAW CHAIN MAINTENANCE

Never operate a chain saw with a dull or damaged chain. If the chain requires excessive pressure to cut or produces dust instead of wood chips then inspect the cutters for damage. When sharpening the chain the objectives will be to maintain the same angles and profiles throughout its life as when it was new. Inspect the chain for damage or wear every time you refuel your chain saw. When the length of the cutting teeth has worn down to only 4 mm the chain must be replaced.

- Sharpening
In order to file the chain correctly you need: round file and file holder (A), flat file (B) and a depth gauge tool (C).
By using the correct file size (4.0 mm Round file) and a file holder, it is easier to receive a good result. Consult your shindaiwa dealer for correct sharpening tools and sizes.

WARNING **DANGER**
SWITCH OFF THE ENGINE BEFORE SHARPENING THE CHAIN.
ALWAYS WEAR GLOVES WHEN WORKING ON CHAIN.

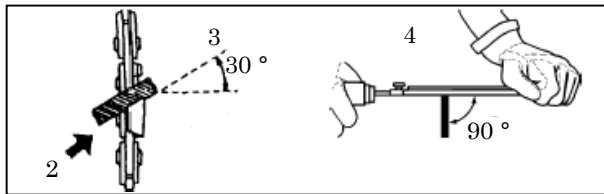

1. Lock the chain - push hand guard forward. To rotate the chain - pull hand guard against front handle.
2. Your chain will have alternative left and right hand cutters. Always sharpen from the inside out.
3. Keep the angle lines of the file holder parallel to the line of the chain and file the cutter back until the damaged area (side plate and top plate) has been removed.
4. Hold the file horizontally.
5. Sharpen the most damaged cutter first and then take all the other cutters back to the same length.

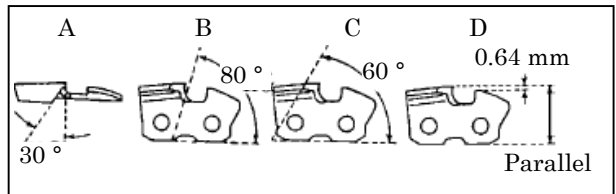

- Properly filed cutters are shown below.
A : Top plate angle 30 °
B : Side plate angle 80 °
C : Top plate cutting angle 60 °
D : Depth gauge 0.64 mm

NOTE
These angles are referred to as Oregon 91VG. For other branded saw chain, follow its chain manufacturer's instruction.

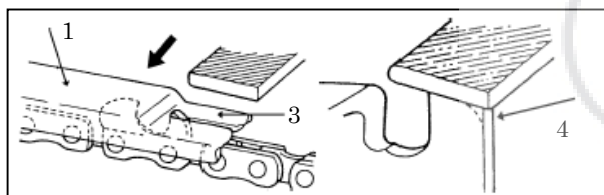

1. The depth control determines the thickness of wood chip produced and must be maintained correctly throughout the chain life.
2. As the cutter length is reduced, the depth control height is altered and must be reduced.
3. Position the depth gauge, and file off any of the depth control which protrudes.
4. Round off the front of the depth control to allow smooth cutting.

(PRECAUTION)

The following faults will increase the risk of kickback considerably.

- 1) Top plate angle too large
- 2) Side plate angle too small
- 3) File diameter too small
- 4) Depth gauge too large

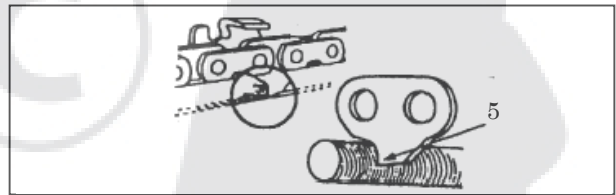

- Drive link serves to remove sawdust from the groove of the guide bar. Therefore, keep the lower edge of the drive link sharp, indicated as 5.

- When setting of the chain is finished, soak it in oil and wash away filings completely before using.
- When chain has been filed on the bar, supply sufficient oil to it, and rotate the chain slowly to wash away the filings before using again.
- If the chain saw is operated with filings clogged in the groove, the saw chain and the guide bar will be damaged prematurely.
- If the saw chain becomes soiled with resin for instance, clean it with kerosene and soak it in oil.

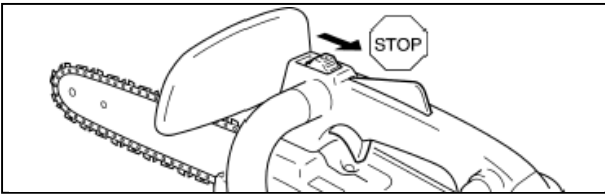

STORAGE

LONG TERM STORAGE (Over 60 days)

WARNING  **DANGER**
DO NOT STORE IN ENCLOSURE WHERE FUEL FUMES MAY ACCUMULATE OR REACH AN OPEN FLAME OR SPARK.

Do not store your unit for a prolonged period of time (60 days or longer) without performing protective storage maintenance which includes the following:

1. Store unit in a dry, dust free place, out of the reach of children and other unauthorized persons.
2. Place the ignition switch in the "STOP" position.

3. Remove accumulation of grease, oil, dirt and debris from exterior of unit.
4. Perform all periodic lubrication and services that are required.
5. Tighten all the screw and nuts.
6. Drain the fuel tank completely and pull the recoil starter handle several times to remove fuel from the carburettor.
7. Always store fuel in approved container.

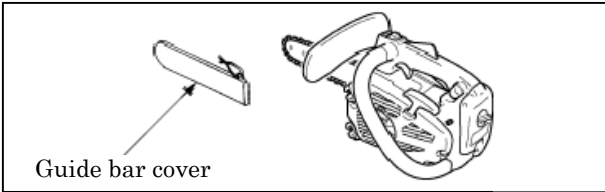

8. Remove the spark plug and pour 1/2 tablespoon of fresh, clean, two-stroke engine oil into the cylinder through the spark plug hole.
 - A. Place a clean cloth over the spark plug hole.
 - B. Pull the recoil starter handle 2 or 3 times to distribute the oil inside the engine.
 - C. Observe the piston location through the spark plug hole. Pull the recoil starter handle slowly until the piston reaches the top of its travel and leave it there.
9. Install the spark plug (do not connect ignition cable).
10. Cover the chain and the guide bar with the guide bar cover before putting them in storage.

NOTE

- For future reference, you should keep this operator's manual.
- If this operator's manual has become illegible through impairment or is lost, please purchase a new one from your shindaiwa dealer.
- When renting a machine together with this operator's manual provides explanation and instruction, please rent out the machine together with this operator's manual to a person who operates the borrowed machine.
- When transferring a product, please deliver it attaching the operator's manual.

SPECIFICATIONS

| | | 269T |
|---|---|---|
| External dimensions : L × W × H | mm | 257 × 219 × 210 |
| Mass : Saw without guide bar and chain, empty tanks | kg | 2.9 |
| Volume : Fuel tank Tank for chain lubrication oil Fuel (Mixture ratio) Octane Unleaded petrol is recommended. Do not use fuel containing methyl alcohol or more than 10 % of ethyl alcohol. 25 : 1 for JASO FA or FB grade oil Oil (Chain oil) | mL mL | 240 160 Regular grade petrol. Minimum 89 Special chain oil or motor oil |
| Guide bar : | | Sprocket nose bar |
| Cutting length : All specified usable cutting lengths of guide bar | mm | 250 |
| Chain : Specified pitch Specified gauge (thickness of drive links) Type of guide bar Guide bar gauge Type of chain Lubrication | mm mm cm mm | 9.53 (3/8 inch) 1.27 (0.050 inch) 25 1.27 (0.050 inch) Oregon 91VG Adjustable automatic oil pump |
| Sprocket : Specified number of teeth | | 6 |
| Engine : Type Carburettor Magneto Spark plug Starter Power transmission Engine displacement Maximum shaft brake power (ISO 7293) Recommended maximum speed with cutting attachment Recommended speed at idling | mL (cm ³) kW r/min r/min | Air cooled 2-cycle single cylinder Diaphragm type Flywheel magneto, CDI system NGK BPMR7A Recoil starter Automatic centrifugal clutch 26.9 0.91 12,000 3,000 |
| Fuel consumption : Fuel consumption at maximum engine power Specific fuel consumption at maximum engine power | kg/h g/(kW·h) | 0.61 677 |
| Sound pressure level : (ISO 7182) LpAav = | dB(A) | 98 |
| Guaranteed sound power level : (2000/14/EC) LWA = | dB(A) | 112 |
| Chain brake : (ISO 6535) Mean braking time at racing speed | s | 0.05 |
| Vibration : (ISO 7505) | m/s ² | 5.9 |
| Other devices : | | Front hand guard, Throttle trigger lockout, Chain catcher, Chain brake, Anti-vibration device |
| Option : | | Spiked bumper |

Specifications, descriptions and illustrative material in this literature are as accurate as known at the time of publication, but are subject to change without notice.

Illustrations may include optional equipment and accessories, and may not include all standard equipment.

DECLARATION OF CONFORMITY

We hereby declare the Shindaiwa Engine Chain saw,
Model 269T(269T/CE)

meets the following respective requirements.

Council Directives:

89/336/EEC as amended
98/37/EC as amended
2000/14/EC as amended

Standard taken:

EN 292 parts 1&2
EN 608
CISPR 12

Measured sound power level: 109dB(A)

Guaranteed sound power level: 112dB(A)

Have successfully passed the CE Mark approval tests carried out by :

TÜV Rheinland
Sicherheit und Umweltschutz GmbH
Zertifizierungs-und Prüfstelle für Gerätesicherheit
Am Grauen Stein, D- 51105 Köln, Germany

Obtained the following register number respectively :BM 60003985 0001

Technical documentation is kept by:

KIORITZ Corporation
7-2 Suehirocho, 1-chome, Ohme, Tokyo, 198-8711, Japan
TEL:81-428-32-6118 , FAX:81-428-32-6145

2003 - 9 - 9



T. Yoshitomi
DIV. Manager
Quality Assurance DIV.

Shindaiwa Kogyo Co., Ltd.

Chiyoda Plant : 35 Shin-ujigami, Chiyoda-cho, Yamagata-
gun, Hiroshima, 731-1597, Japan
TEL:81-826-72-6022 , FAX:81-826-72-7004





Shindaiwa Kogyo Co.,Ltd.

Head Office : 6-2-11 Ozuka-Nishi
Asaminami-Ku, Hiroshima,
731-3167, Japan

TEL:81-82-849-2220
FAX:81-82-849-2481