

NOTICE D'UTILISATION ET D'ENTRETIEN

OPERATING AND MAINTENANCE INSTRUCTIONS

BETRIEBS UND WARTUNGSANLEITUNG

ISTRUZIONI PER L'USO E LA MANUTENZIONE

MANUAL DE UTILIZACION Y MANTENIMIENTO

HANDLEING VOOR GEBRUIK EN ONDERHOUD

INSTRUÇÕES DE UTILIZAÇÃO E MANUTENÇÃO

S 800

S 802

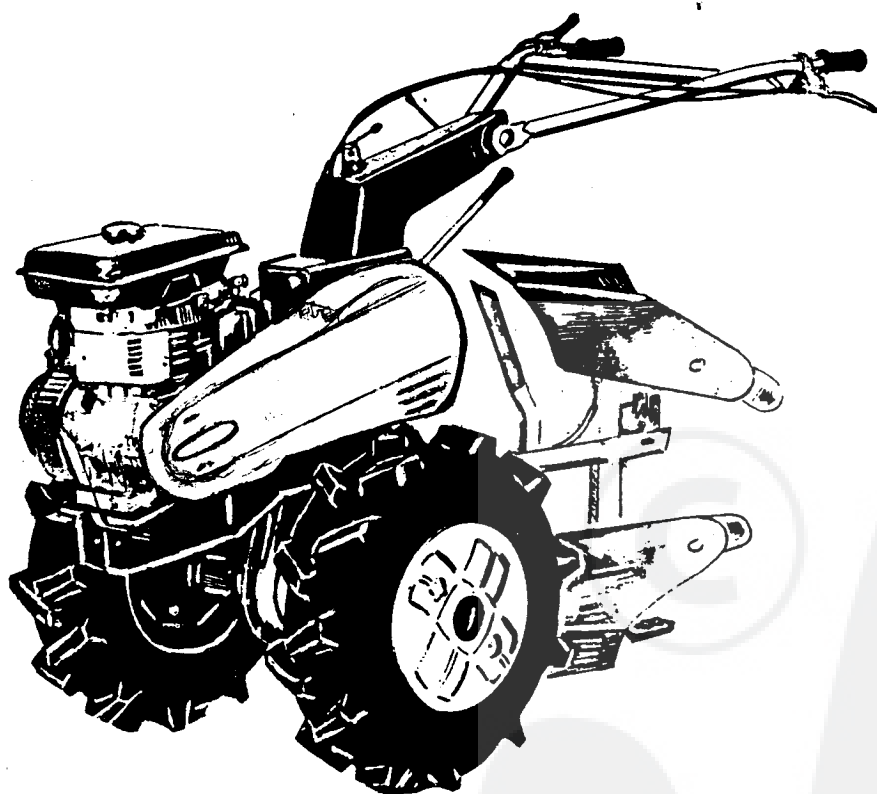

**CERTIFICAT DE GARANTIE
WARRANTY - GARANTIE - GARANZIA
GARANTIA - GARANTIE - GARANTIA**

SIGNATURE ET CACHET DU VENDEUR
STAMP - STEMPEL - TIMBRO - SELLO - STEMPEL - CARIMBO

DATE / DATE / TAG / DATA
FECHA / DATUM / DATA :



**MOTOCULTEUR • CONVERTIBLE CULTIVATOR
EINACHSSCHLEPPER • MOTOCULTIVATORE
MOTOCULTOR • MOTORPLOEG • MOTOCULTIVADOR**

PILOTE 88 s.a. 11, rue Jules Ferry - BP 185 - 88207 REMIREMONT CEDEX - France -
☎ (33) 03.29.23.36.64 - Fax. (33) 03.29.23.24.25

CARACTERISTIQUES TECHNIQUES		
	BRIGGS & STRATTON	HONDA
MOTEUR	Monocylindre 4 Temps	
MODÈLE	135292	GX 160 OHV
CYLINDRÉE	206 cc	163 cc
PUISSANCE	5 cv à 3600 Trs/mn	5,5 cv à 3600 Trs/mn
CAPACITÉ HUILE	0,6 L	0,6 L
ESSENCE	2,8 L	3,6 L
BOUGIE	CHJAMPION CJ 8 ou équivalent	NGK BP 6 ES ou équivalent
LUBRIFIANT	Huile moteur SAE 20 W 40	
CARBURANT	Super sans plomb indice d'octane 98	

Niveau sonore mesuré depuis le poste de travail : 85 dB(A).
Mesure de vibrations aux poignées de manchons, selon 1033.1 : 7,8 m/s²

Transmission :

- Par courroie trapézoïdale avec embrayage par galet tendeur.
- Boîte pont : 2 rapports avant + 1 rapport arrière commandé par un levier de vitesses.

Selon version : Décrabottage, permettant de désaccoupler la roue gauche ou la roue droite.

Vitesse ou régime moteur maxi : 1^{er} rapport : 32 tr - 2,8 km/h
2^e rapport : 104 tr - 9,17 km/h
Marche arrière : 35,5 tr - 3,1 km/h

Vitesse de rotation des outils : 90 tr/mn soit sur le deuxième rapport,

moteur non accéléré au maxi

Mancheron : réglable en hauteur et en déport

Poids cellule nue : environ 55 kg

Poids motobineuse : environ 65 kg

Poids motoculteur équipé : environ 160 kg

 **AVANT DE METTRE VOTRE MACHINE EN MARCHÉ, VEUILLEZ LIRE ATTENTIVEMENT LA NOTICE DU MOTEUR AINSI QUE LES INSTRUCTIONS DE CE MANUEL.**

Dans le but d'améliorer ses produits et d'être en conformité avec les normes européennes, PILOTE 88 se réserve le droit de modifier sans préavis les caractéristiques des machines.

TECHNISCHE DATEN		
	BRIGGS & STRATTON	HONDA
MOTOR	Einzyylinder 4 Takt	
MODELL	135292	GX 160 OHV
HUBRAUM	206 ccm	163 ccm
LESTUNG	5 PS bei 3.600 min ⁻¹	5,5 PS bei 3.600 min ⁻¹
INHALT ÖL	0,6 Liter	0,6 Liter
BENZIN	2,8 Liter	3,6 Liter
ZUNDKERZEN	CHJAMPION CJ 8 oder entsprechend	NGK BP 6 ES oder entsprechend
MOTORENÖL	Motorenöl SAE 20 W 40	
KRAFTSTOFF	Bleifreies Benzin Oktanzahl 98	

Geräuschpegel am Arbeitsplatz gemessen : für jedes Modell 85 dB(A) im Leerlauf
Holm vibration nach, EN 1033.1 : 7,8 m/s²

ÜBERSETZUNG :

- Durch Keilriemen mit Spannrollenkupplung
- Getriebe : 2 Vorwärtsgänge + 1 Rückwärtsgang, bedienung über Schalthebel

In option : Linke oder rechte rad, Klauenkupplung

Bei maximaler Motorendrehzahl : 1 Gang : 32 Umdrehungen - 2,8 km/h
2 Gang : 104 Umdrehungen - 9,17 km/h
Rückwärtsgang : 35,5 Umdrehungen - 3,1 km/h

DREHGESCHWINDIGKEIT der Werkzeuge : 90 Umdrehungen/min, d.h. im zweiten Gang bei mittlerer Geschwindigkeit

STERZ Höheneinstellbar und seitliche Einstellung.

GEWICHT Einachsschlepper allein : ungefähr 55 kg

GEWICHT Motorhacke : ungefähr 65 kg

GEWICHT Einachsschlepper : ungefähr 160 kg

 **ACHTUNG : BEVOR SIE DIE MASCHINE IN BETRIEB NEHMEN, BITTE AUFMERKSAM DIE MOTORANLEITUNG SOWIE DIE ANGABEN DIESER ANLEITUNGEN DURCHLESEN.**

Um Ihr Produkt zu verbessern und mit den Europäischen Normen übereinzustimmen behält sich die Firma PILOTE 88 das Recht vor die Eigenschaften der Maschinen ohne Vorankündigung zu ändern.

TECHNICAL SPECIFICATIONS		
	BRIGGS & STRATTON	HONDA
ENGINE	All single cylinder 4 stroke engines	
TYPE	All single cylinder 4 stroke engines	
MODEL	135292	GX 160 OHV
CAPACITY	206 cc	163 cc
H.P.	5 / 3600 RPM	5,5 / 3600 RPM
OIL CAPACITY	0,6 L	0,6 L
FUEL CAPACITY	2,8 L	3,6 L
SPARK PLUG	CHJAMPION CJ 8 or equivalent	NGK BP 6 ES or equivalent
ENGINE OIL	SAE 20 W 40	
FUEL	Lead-free 98 octane	

Sound level measured ta operators position : 85 decibels.
Handle vibrations, EN 1033.1 : 7,8 m/s²

TRANSMISSION :

- Vee-belt and clutch type belt tensioner.
- Gear box : 2 forward ratios + 1 rear ratio, control by speed lever.

Optional : Claw decoupling at wheel left or right.

At max. engine speed : 1st ratio : 32 rev - 2,8 km/h
2nd ratio : 104 rev - 9,17 km/h
Reverse : 35,5 rev - 3,1 km/h

Rotation speed of cultivating tools : 90 rev/min, on 2nd ratio, motor not at full speed

Handlebars are adjustable in height and oriantation.

Weight cultivator bare : approximately 55 kg

Weight tiller : approximately 65 kg

Weight cultivator : approximately 160 kg

 **WARNING : BEFORE STARTING YOUR CULTIVATOR, READ THE MOTOR INSTRUCTION MANUAL CAREFULLY AS WELL AS THE PRESENT MANUAL.**

In an effort to improve its product and comply with european norms, PILOTE 88 reserves the right to modify certain characteristics without prior notice.

CARATTERISTICHE TECHICHE		
	BRIGGS & STRATTON	HONDA
MOTORE	Monocilindrico 4 T	
MODELLO	135292	GX 160 OHV
CILINDRATA	206 cc	163 cc
POTENZA	5 CV a 3600 G/min	5,5 CV a 3600 G/min
CAPACITA OLIO	0,6 l	0,6 l
BENZINA	2,8 l	3,6 l
CANDELLA	CHJAMPION CJ 8 o equivalente	NGK BP 6 ES o equivalente
LUFRIFICANTE	Olio motore SAE 20 W 40	
CARBURANTE	Benzina senza piombo 98 ottani	

Livello sonore : 85 dB(A)

Misura di vibrazioni al manubrio secondo norma 1033.1 : 7,8 m/s²

TRASMISSIONE :

- Mediane cinghia trapezoidale con frizione mediante rullo tenditore
- Cambio ponte : 2 rapporti anteriore + 1 rapporto posteriore comandato da una leva di cambio

Secondo version : disinnesto che permette di disaccoppiare la ruota sinistra o la ruota destra

Giri al regime motore massimo : 1° rapporto : 32 giri - 2,8 km/h
2° rapporto : 104 giri - 9,17 km/h
Retromarcia : 35,5 giri - 3,1 km/h

Velocita di rotazione degli utensili : 90 giri/min sul secondo rapporto motore non accelerato al massimo

Stegola : regolabile in altezza ed in sbandamento

Peso cellula nuda : circa 55 kg

Peso motosarchiatrice : circa 65 kg

Peso motocultivatore attrezzato : circa 160 kg

 **PRIMA DI METTERE IN MOTOR LA MACCHINNA VI PREGHIAMO DI LEGGERE ATTENTAMENTE IL LIBRETTO ISTRUZIONI DEL MOTORE E LE ISTRUZIONI CONTENUTE IN QUESTO MANUALE.**

Con l'intento di migliorare i suoi prodotti, e di essere in conformita con le norme Europee, PILOTE 88 si riserva il dirto di modificarli i senza preavviso.

CARACTERISTICAS TECNICAS		
	BRIGGS & STRATTON	HONDA
MOTOR	Monocilindrico 4 tiempos	
MODELLO	135292	GX 160 OHV
CILINDRADA	206 cc	163 cc
POTENCIA	5 cv à 3600 RPM	5,5 cv à 3600 RPM
CAPACIDAD (aceite)	0,6 L	0,6 L
CAPACIDAD (gasolina)	2,8 L	3,6 L
BUGIA	CHJAMPION CJ 8 o equivalente	NGK BP 6 ES o equivalente
LUBRICANTE	Aceite de motor SAE 20 W 40	
CARBURANTE	Gasolina sin plomo de 98 octanes	

Nivel sonoro medido desde el puesto de trabajo : 85 db
Vibracion y mango, EN 1033.1 : 7,8 m/s²

Transmisión :

- Por correa trapezoidal con embrague por rodillo tensor.
- Caja puente : 2 relaciones delanteras + 1 relación trasera controlada mediante una palanca de velocidades.

Según versión : desembrague, que permite el desacoplamiento de la rueda izquierda o de la rueda derecha.

Velocidades en el régimen motor máximo : 1ª relación : 32 tr - 2,8 km/h
2ª relación : 104 tr - 9,17 km/h
Marcha atrás : 35,5 tr - 3,1 km/h

Velocidad de rotación de las herramientas : 90 tr/mn, en la segunda relación, motor no acelerado al máximo

Mancera : ajustable en altura y en asimetría

Peso célula desnuda : aproximadamente 55 kg

Peso motobinadora : aproximadamente 65 kg

Peso motocultor equipado : aproximadamente 160 kg



ANTES DE LA PUESTA EN MARCHA DE SU MAQUINA, LE ACONSEJAMOS LEER ATENTAMENTE EL MANUAL DEL MOTOR Y EL PRESENTE MANUAL.

Con el fin de mejorar sus productos, y de estar en conformidad con las normas Europeas, PILOTE 88 se reserva el derecho de modificar sin previo aviso las características de los mismos.

TECHNISCHE GEGEVENS		
	BRIGGS & STRATTON	HONDA
MOTOR	Eencilinder 4 - takt	
TYPE	Eencilinder 4 - takt	
MODEL	135292	GX 160 OHV
CILINDERINHOUD	206 cc	163 cc
VERMOGEN	5 pk *	5,5 pk *
Inhoud OLJETANK	0,6 L	0,6 L
Inhoud BENZINTANK	2,8 L	3,6 L
BOUGIE	CHJAMPION CJ 8 of gelijkwaardig	NGK BP 6 ES of gelijkwaardig
OLIE	SAE 20 W 40	
BRANDSTOF	Loodvrije superbenezine octaangehalte 98	

* Bij 3600 omw/min.

Geluidniveau gemeten op hoofdhoogte gebruiker : 85 dB(A)
Trillingsmetting aan het stuur volgens de norm 1033.1 : 7,8 m/s²

Overbrenging :

- V-snaar met koppeling door spanrol.
- Versnellingsbak : 2 vooruit + 1 achteruit, bediening door snelheidshendel.

Volgens uitvoering : ont koppeling van het linker of het rechter wiel.

Snelheden op maximaal motorvermogen : 1ste versnelling : 32 toeren - 2,8 km/h
2de versnelling : 104 toeren - 9,17 km/h
Achteruit : 35,5 toeren - 3,1 km/h

Draaisnelheid werktuigen : 90 tpm, in de tweede versnelling, motor niet tot maximum versneld.

Ploegstaart : instelbaar in hoogte en verschuiving

Gewicht kale cel : circa 55 kg

Gewicht schoffelmachine : circa 65 kg

Gewicht uitgeruste motorploeg : circa 160 kg



VOOR DE HAKFRES IN GEBRUIK NEEMT, GELIEVE U DE MOTOREN FREESHANDLEIDINGEN TE LEZEN.

PILOTE 88 verbetert haar producten voortdurend en behoudt zich het recht voor, technische gegevens zonder voorafgaande kennisgeving te wijzigen, en te voldoen aan de Europese Normen.

ESPECIFICAÇÕES TECNICAS		
	BRIGGS & STRATTON	HONDA
MOTOR	Monocilindro 4 Tempos	
MODELO	135292	GX 160 OHV
CILINDRADA	206 cc	163 cc
POTENCIA	5 CV à 3600 r.p.m.	5,5 CV à 3600 r.p.m.
CAPACIDADE OLEO	0,6 L	0,6 L
CAPACIDADE GASOLINA	2,8 L	3,6 L
VELA	CHJAMPION CJ 8 ou equivalente	NGK BP 6 ES ou equivalente
LUBRIFICANTE	Oleo para motor SAE 20 W 40	
CARBURANTE	Gasolina sem chumbo de 98 octanas	

Nível sonoro, medido na posição de trabalho, para cada modelo : 85 decibéis.
Medição das vibrações na guia de acordo com as normas 1033.1 : 7,8 m/s²

TRANSMISSÃO

- Através de correia trapezoidal com embraiagem por junta de extensão.
- Caixa de velocidades : 2 mudanças de marcha à frente + 1 mudança de marcha atrás comandadas uma alavanca de velocidades.

Consoante a versão : aceleração que permite desacoplar a roda do lado esquerdo ou a roda do lado direito.

Velocidades ao regime maximo do motor : 1ª marcha : 32 tr - 2,8 km/h
2ª marcha : 104 tr - 9,17 km/h
Marcha atrás : 35,5 tr - 3,1 km/h

Velocidade de rotação das ferramentas : 90 tr/mn para a segunda marcha, com o motor não acelerado até a velocidade maxima.

Pega : ajustavel em altura e em extensão

Peso da célula vazia : aproximadamente 55 kg

Peso com sachador mecanico : aproximadamente 65 kg

Peso equipado com motocultivador : aproximadamente 160 kg



NTES DE PÔR A SUA MAQUINA A FUNCIONAR, LEIA ATENTAMENTE A BROCHURA DO MOTOR, BEM COMO AS INSTRUÇÕES DESTES MANUAL.

Com o objectivo de melhorar a qualidade dos seus produtos, e de estar em conformidade com as normas Europeias, PILOTE 88 reserva se a direito de alterar certas características sem aviso prévio.

- Commande d'accélération
Throttle control
Gashebel
Acceleratore
Palanca de gases
Accelerador
Gashendel

- Levier d'embrayage
Drive clutch lever
Antriebshebel
Leva di comando
Palanca del embrague
Alavanca
Koppelingshendel

- Levier de vitesses
Gear lever
Scholthebel
Leva del cambio
Palanca de cambios
Alavanca
Versnellingshendel

- Capot de protection
Mud guard
Schultzblech
Protezione
Guardabarros
Capot
Kapo

- Disque protège-plantes
Protectors
Pflanzenschutz
Dischi
Salvaplantas
Disco
Schijf

6 - Roue de transport
Transport wheel
Transport rad
Ruota
Rueda de transporte
Roda
Wiel

7 - Ecrou de réglage latéral
Lateral adjustment nut
Versetze Einstellung
Dado bloccaggio laterale
Tuerca de bloqueo lateral
Porca de travagem lateral
Vlengelmoeer stuurmontage

8 - Ecrou de réglage en hauteur
Height adjustment nut
Höhensicherungsmutter
Dado bloccaggio in altezza
Tuerca de bloqueo altura
Porca de travagem em altura
Vlengelmesser stuuroogteverstelling

9 - Bouton d'arrêt moteur (Honda)
Engine switch (Honda)
Motorabstellknopf (Honda)
Interruttore d'arresto (Honda)
Interruptor motor (Honda)
Interruptor de parada (Honda)
Stopschakelaar (Honda)

10 - Levier de débrayage droite
Claw decoupling right
Rechte Klanenkupplung
Manopola di comando di disinnesto
Punho de comando da desacoplar
Ontkoppelingsgreep
Mando de desembrague

11 - Levier de débrayage gauche
Claw decoupling left
Linkse Klanenkupplung
Manopola di comando di disinnesto
Punho de comando da desacoplar
Ontkoppelingsgreep
Mando de desembrague

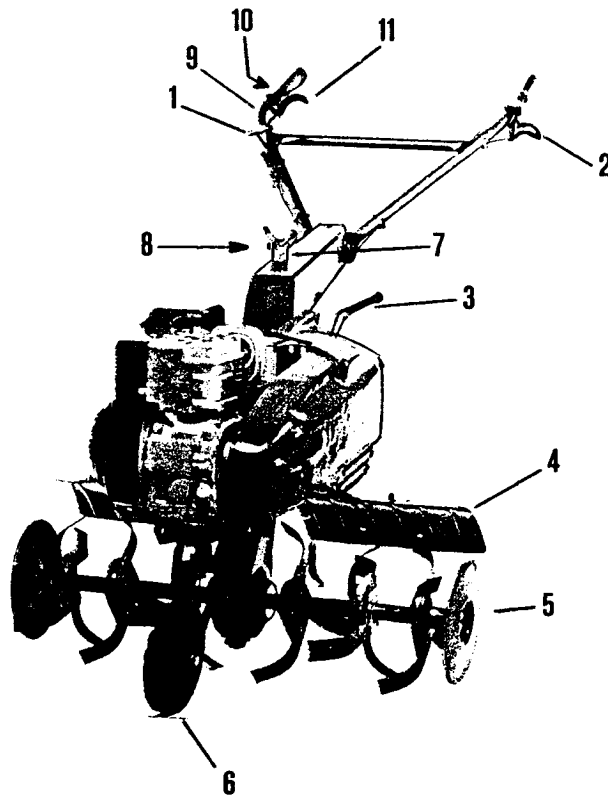

**MEVER LA ROUE DE TRANSPORT
OUR LE TRAVAIL.**

**MOVE THE TRANSPORT WHEEL
WHEN WORKING.**

**UM ARBEITEN, DAS TRANSPORTRAD
ENTFERNEN.**

**OGLIERE LA RUOTA DI TRASPORTO
ER IL LAVORO.**

**ARA TRABAJAR, QUITE LA RUEDA
E TRANSPORTE.**

**ETIRAR LA RODA DE TRANSPORTE
ARA INICIAR OS TRABALHOS.**

**OR HEET WERK HET TRANSPORT-
WIEL VERWIJDEREN.**

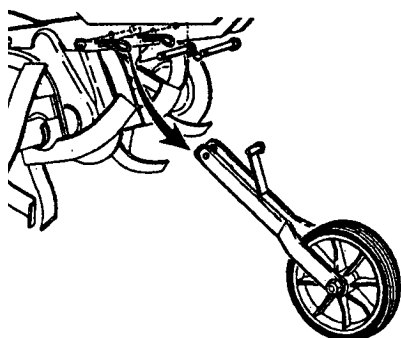

**RÈGLAGE DE LA BÉQUILLE
DE TERRAGE :**

La profondeur de terre travaillée est fonction du réglage de profondeur de la béquille.
=> plus la béquille est réglée basse, plus la machine travaille en profondeur.

NOTE : La vitesse de progression de la machine est fonction de l'appui plus ou moins important sur le mancheron. Pour freiner, on appuie sur le mancheron et inversement.

**REGOLAZIONE DEL
PUNTONE :**

La profondità del terreno lavorato e in funzione della regolazione di profondità del puntone. Più il puntone e regolato basso, più la macchina lavora in profondità.

NOTA : La velocità di avanzamento si ottiene in funzione della pressione esercitata sul manico, per frenare appoggiarsi al manico e vice-versa.

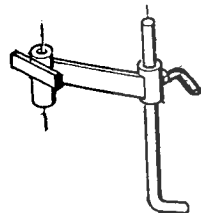

DRAG-LEG ADJUSTMENT :

The depth at which you wish to cultivate depends on the adjustment of the leg, the deeper the leg is adjusted the deeper will be depth of tilling.

NOTE : The forward speed of the cultivator depends on the downwards pressure given on the handlebars, to slow the cultivator, apply a strong downwards pressure and vice-versa.

**REGULACION DEL ESPOLON
DE PROFUNDIDAD :**

La profundidad de la tierra trabajada va siempre en función de regulación del espolón. Cuanto más bajo este regulado el espolón, más profundo trabaja la máquina.

NOTA : La velocidad de avance de la máquina ira siempre en función de la fuerza que Ud. ejerza sobre el manillar. Para frenar se apoya en el manillar y para avanzar lo contrario.

REGULAÇÃO DO APOIO-GUIA DE PROFUNDIDADE :

A profundidade do trabalho no terreno depende da regulação da profundidade do apoio-guia respectivo => quanto mais descida está a guia, maior é a profundidade a que a máquina trabalha.

NOTA : A velocidade de progressão da máquina depende da maior ou menor pressão exercida sobre a rabiça. Para travar, carrega-se mais na rabiça e vice-versa.

**EINSTELLUNG DER TIEFE-
NEIN-STELLVORRICHTUNG :**

Die Arbeitstiefe hängt von der Einstellung der Tiefeneinstellvorrichtung ab.
=> Je tiefer diese Stütze eingestellt ist, desto tiefer arbeitet die Motorhacke.

BEMERKUNG : Die Vorwärtsgeschwindigkeit der Maschine hängt davon ab, wie stark Sie auf die Griffe drücken. Zum Bremsen drückt man stark darauf, um schneller zu arbeiten, drückt man nur leicht darauf.

FREESDIEPTE INSTELLEN :

De freesdiepte wordt met de diepgangsstaf ingesteld.
=> Hoe korter deze wordt afgesteld, des te groter de freesdiepte zal zijn.

NB : De voortloopsnelheid van de freesmachine hangt af van de op het stuur uitgeoefende druk. Hoe groter de druk, des te geringer de snelheid.

**DECRABOTAGE - CLAW DECOUPLING - DESEMBRAGUE - KLAUENKUPPLUNG
 COMMANDO DI DISINNESTO - ONTKOPPELING - DESACOPLAGEM**

A - Poignée de commande de décrabotage droite
 Decoupling handle - right
 Manillar derecho de mando de desembrague
 Schaltgriff für die rechte Klauenkupplung
 Manopola di comando di disinnesto
 Ontkoppelingsgreep
 Punho de comando da aceleração

B - Poignée de commande de décrabotage gauche
 Decoupling handle - left
 Manillar izquierdo de mando de desembrague
 Schaltgriff für die linke Klauenkupplung
 Manopola di comando di disinnesto
 Ontkoppelingsgreep
 Punho de comando da aceleração

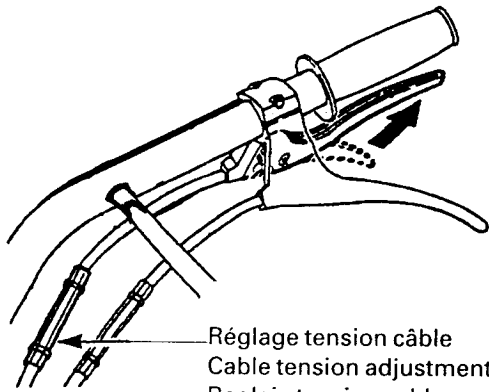

Réglage tension câble
 Cable tension adjustment
 Reglaje tension cable
 Einstellung der Kabelspannung
 Regolazione tensione cavo
 Instelling van de kabelspanning
 Ajustamento do cabo de tensão

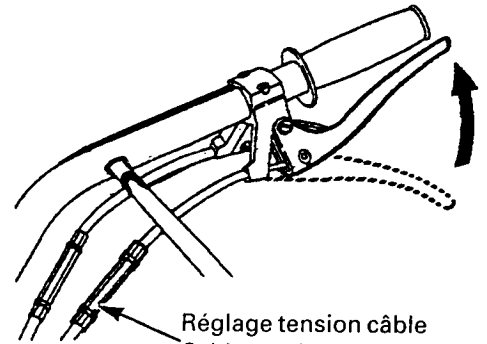

Réglage tension câble
 Cable tension adjustment
 Reglaje tension cable
 Einstellung der Kabelspannung
 Regolazione tensione cavo
 Instelling van de kabelspanning
 Ajustamento do cabo de tensão

**REGLAGE DE LA TENSION DE LA COURROIE - TO ADJUST THE BELT
 EINSTELLUNG DER RIEMEN - REGLAJE TENSION CORREA
 REGOLAZIONE TENSIONE CINGHIA - INSTELLING VAN DE RIEM
 AJUSTAMENTO DA CORREA**

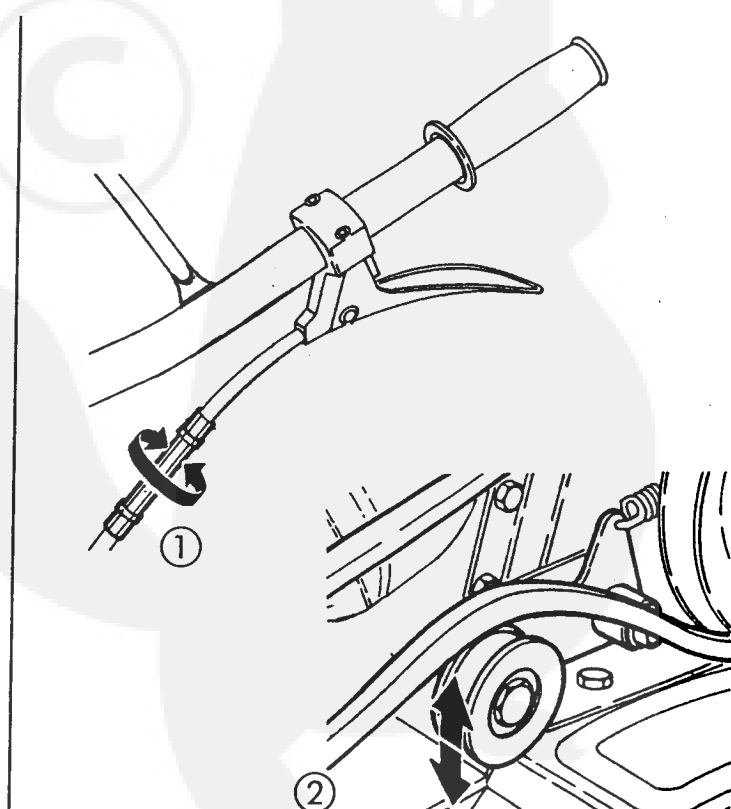
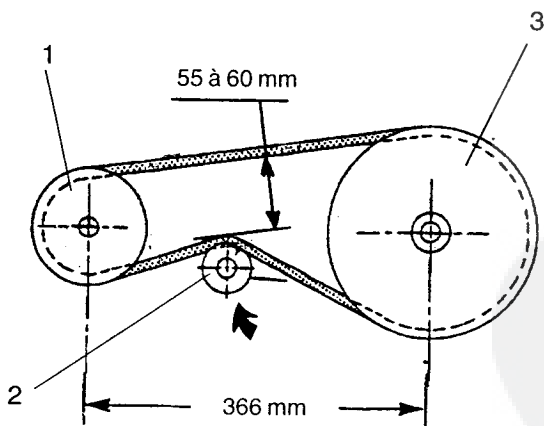

- | | | |
|--------------------|-------------------|-----------------------|
| 1 - Poulie motrice | 2 - Galet tendeur | 3 - Poulie réceptrice |
| Drive pulley | Tensioner wheel | Receiving pulley |
| Treibrad | Riemenspannrolle | Treibrad |
| Puleggia motor | Puleggia | Puleggia |
| Polea motor | Polea tensor | Polea receptora |
| Polia motor | Polia | Polia |
| Riemschijf | Rol | Riemschijf |

Motobineuse sans débrayage / Tiller without Claw Decoupling
Motobinadora sin desembrague / Motorhacke ohne Klauenkupplung

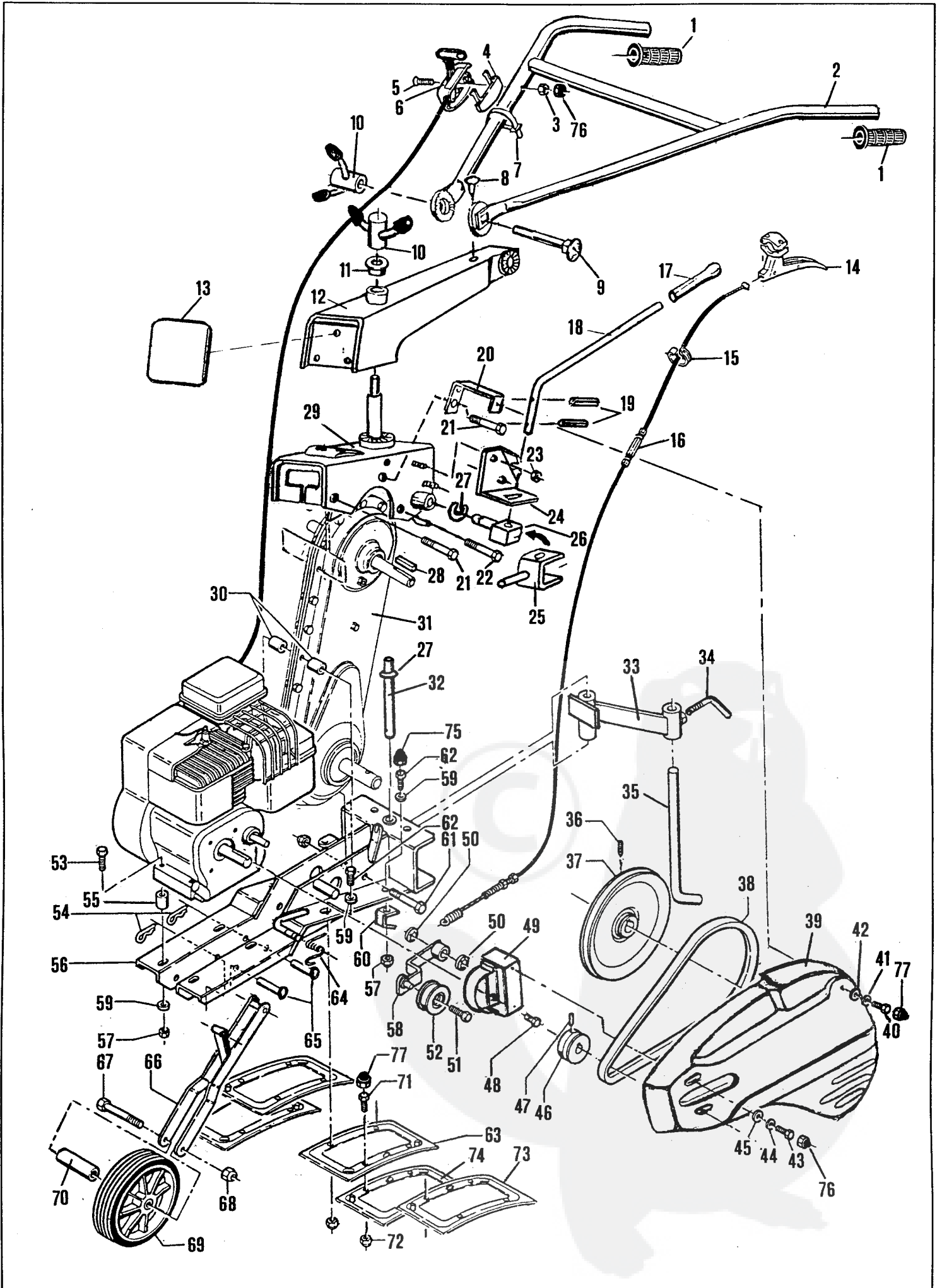

Fig.	Références	Désignation	Part Name	Bezeichnung	Descrizione	Descripcion	Designação	Omschrijving	Qté
1	16706	Poignée	Handle	Sterzgriff	Manopola	Empunadura	Pega de rabiça	Handgriep	2
2	34243	Mancheron	Handlebar	Sterz	Manico	Manillar	Rabiça	Handgriep	1
3	Z53.5	Ecrou	Nut	Mutter	Dado	Tuerca	Parafuso	Moer	1
4	30407	Boitier	Plastic cap	Griffabdeckung	Copri	Tapon plastico	Tampao plastico	Kunststofkap	1
5	Z03.5.45	Vis	Screw	Schraube	Vite	Tornillo	Parafuso	Schroef	1
6	30525	Commande d'accélération	Throttle control	Gashebelgestange	Commando	Acceleratore	Accelerator	Gashebel	1
7	73112	Collier	Clip	Klemmschelle	Ferma cavo	Abrazadera	Gancho	Kabelbinder	2
8	11064	Bouchon	Plastic cap	Verschluß	Copri	Tapon plastico	Tampao plastico	Kunststofkap	1
9	Z42.12.120	Vis	Screw	Schraube	Vite	Tornillo	Parafuso	Schroef	1
10	30748	Ecrou	Nut	Mutter	Dado	Tuerca	Parafuso	Moer	2
11	34066	Bague	Spacer	Abstandsstücke	Distanziale	Distanciador	Separador	Afstandsstuk	1
12	34070	Potence	Bracket	Träger	Supporto	Sosten manillar	Quadro	Juk	1
13	34231	Calandre	Plastic cap	Verschluß	Copri	Embellecedor	Calote	Dop	1
14	34357	Levier	Lever clutch	Kupplungsgriff	Manopola	Maneta	Alavanca	Koppelingshendel	1
15	42032	Collier	Clip	Klemmschelle	Ferma cavo	Abrazadera	Gancho	Kabelbinder	2
16	34232	Timonerie	Clutch control	Gestange	Cavo semovenza	Mando de embrague	Commando	Koppelingsstang	1
17	10661	Poignée	Lever handle	Hebelgriff	Capucha	Tapon plastico	Tampao plastico	Kunststofkap	1
18	34244	Levier	Lever	Schalthebel	Leva	Palanca	Hevel	Braco	1
19	013.4.30	Goupille	Pin	Splint	Spina	Pasador	Pino	Borgpen	2
20	34234	Support	Support	Träger	Supporto	Soporte	Suporte	Steun	1
21	Z04.10.130	Boulon	Screw	Schraube	Vite	Tornillo	Parafuso	Schroef	2
22	Z04.10.120	Boulon	Screw	Schraube	Vite	Tornillo	Parafuso	Schroef	1
23	Z11.6	Ecrou	Nut	Mutter	Dado	Tuerca	Parafuso	Moer	2
24	34062	Grille de vitesses	Support	Träger	Supporto	Soporte	Suporte	Steun	1
25	34055	Doigt de vitesses	Gear finger	Antriebswelle	Astina	Arbal primario	Eixo	Wiel	1
26	11078	Pivot	Axle	Achse	Astina	Eje	Eixo	Wielas	1
27	062.RS.12	Circlips	Circlip	Clips	Seeger	Circlips	Anel	Circlip	2
28	11006	Clavette	Key	Splint	Chiavetta	Clavigia	Pino	Pin	1
29	34045	Support de potence	Support	Träger	Supporto	Soporte	Suporte	Steun	1
30	34022	Entretoise	Spacer	Anstandschiüle	Distanziale	Distanciador	Separador	Afstandsbruis	8
31	34241	Carter	Carter	Carter	Scocca	Carter	Carter	Aandrijfkap	1
32	11264	Cheville	Axle	Achse	Astina	Eje	Eixo	Wielas	1
33	34256	Support	Support	Träger	Supporto	Soporte	Suporte	Steun	1
34	30615	Clé de blocage	Pin	Schlüssel	Vite	Tornillo	Chave	Borghevel	1
35	34257	Eperon	Leg	Stutze	Puntone	Espolon	Apaió	Spoortstang	1
36	025.6.12	Vis	Screw	Schraube	Vite	Tornillo	Parafuso	Schroef	1
37	34028	Poulie	Pulley	Treibrad	Puleggia	Polea	Polia	Riemenschijf	1
38	34229	Courroie	Belt	Riemen	Cinghia	Correa	Correia	Riem	1
39	34235	Capot	Cover	Riemenhaube	Coperchio	Capo	Cobertura	Kap	1
40	Z03.6.16	Vis	Screw	Schraube	Vite	Tornillo	Parafuso	Schroef	1
41	Z12.6AZ	Rondelle	Washer	Scheibe	Rondella	Arandela	Anilha	Ring	1
42	Z08.L6N	Rondelle	Washer	Scheibe	Rondella	Arandela	Anilha	Ring	1
43	Z03.5.30	Vis	Screw	Schraube	Vite	Tornillo	Parafuso	Schroef	2
44	Z08.L5N	Rondelle	Washer	Scheibe	Rondella	Arandela	Anilha	Ring	2
45	Z12.5AZ	Rondelle	Washer	Scheibe	Rondella	Arandela	Anilha	Ring	2
46	34027	Poulie	Pulley	Treibrad	Puleggia	Polea	Polia	Riemschijf	1
47	052.8.8	Vis	Screw	Schraube	Vite	Tornillo	Parafuso	Schroef	1
48	Z03.792416	Vis	Screw	Schraube	Vite	Tornillo	Parafuso	Schroef	2
49	34233	Guide-courroie	Veebelt guide	Riemenführung	Guida cinghia	Guia de correia	Guia de correia	Drijfriemgeleider	1
50	062.RS.9	Circlips	Circlip	Clips	Seeger	Circlips	Anel	Circlip	2
51	Z03.10.20	Vis	Screw	Schraube	Vite	Tornillo	Parafuso	Schroef	1
52	11030	Galet	Tensioner wheel	Riemenspannrolle	Puleggia	Polea	Polia	Rol	1
53	Z03.8.55	Vis	Screw	Schraube	Vite	Tornillo	Parafuso	Schroef	4
54	16667	Goupille	Pin	Splint	Coppoglia	Pasador	Cavilha	Borgpen	2
55	16245	Entretoise	Spacer	Abstandshüle	Distanziale	Distanciador	Separador	Afstandsstuk	4
56	34242	Chassis	Frame	Rhamen	Chassis	Chasis	Chassis	Chassis	1
57	Z53.8	Ecrou	Nut	Mutter	Dado	Tuerca	Parafuso	Moer	10
58	30557	Bras de galet	Arm	Vorrichtung	Leva	Leva	Braço	Rolarm	1
59	Z08.L8N	Rondelle	Washer	Scheibe	Rondella	Arandela	Anilha	Ring	14
60	34237	Patte	Support	Trager	Supporto	Soporte	Suporte	Steun	2
61	Z04.10.70	Boulon	Screw	Schraube	Vite	Tornillo	Parafuso	Schroef	4
62	Z03.8.20	Vis	Screw	Schraube	Vite	Tornillo	Parafuso	Schroef	6
63	34238	Capot d'outils D.	Stone guard R.	Werkzeug Haube R.	Protezione Dx	Capot D.	Capot D.	Kapo R.	1
	34239	Capot d'outils G.	Stone guard L.	Werkzeug Haube L.	Protezione Sx	Capot I.	Capot E.	Kapo L.	1
64	30563	Ressort	Spring	Feder	Molla	Muelle	Mola	Veer	1
65	34246	Cheville	Pin	Splint	Perno	Pasador	Cavilha	Borgpen	2
66	34261	Fourche	Fork	Radgabel	Supporto	Horquilla	Forquilha	Vork	1
67	Z03.10.80	Vis	Screw	Schraube	Vite	Tornillo	Parafuso	Schroef	1
68	Z53.10	Ecrou	Nut	Mutter	Dado	Tuerca	Parafuso	Moer	1
69	30601	Roue	Wheel	Rad	Ruota	Rueda	Roda	Wiel	1
70	30602	Coussinet	Spacer	Anstandshüle	Distanziale	Distanciador	Separador	Afstandsstuk	1
71	Z03.6.10	Vis	Screw	Schraube	Vite	Tornillo	Parafuso	Schroef	12
72	Z53.6	Ecrou	Nut	Mutter	Dado	Tuerca	Parafuso	Moer	12
73	33879	Extension G.	Extension L.	Verbreiterung L.	Estensione S.	Estencion I.	Extensão E.	Extra L spatbord	1
	33880	Extension D.	Extension R.	Verbreiterung L.	Estensione D.	Estencion D.	Extensão D.	Extra R spatbord	1
74	34264	Extension D/G	Extension R/L	Verbreiterung R/L	Estensione D/S	Estencion D/I	Extensão D/E	Extra R/L spatbord	2
75	31530	Cache-écrou	Plastic cap	Mutterabdeckung	Copri	Tapon plastico	Tampão plastico	Kunststofkap	5
76	31529	Cache-écrou	Plastic cap	Mutterabdeckung	Copri	Tapon plastico	Tampão plastico	Kunststofkap	3
77	31494	Cache-écrou	Plastic cap	Mutterabdeckung	Copri	Tapon plastico	Tampão plastico	Kunststofkap	13

Motobineuse sans décrabotage / Tiller without Claw Decoupling
Motobinadora sin desembrague / Motorhacke ohne Klauenkupplung

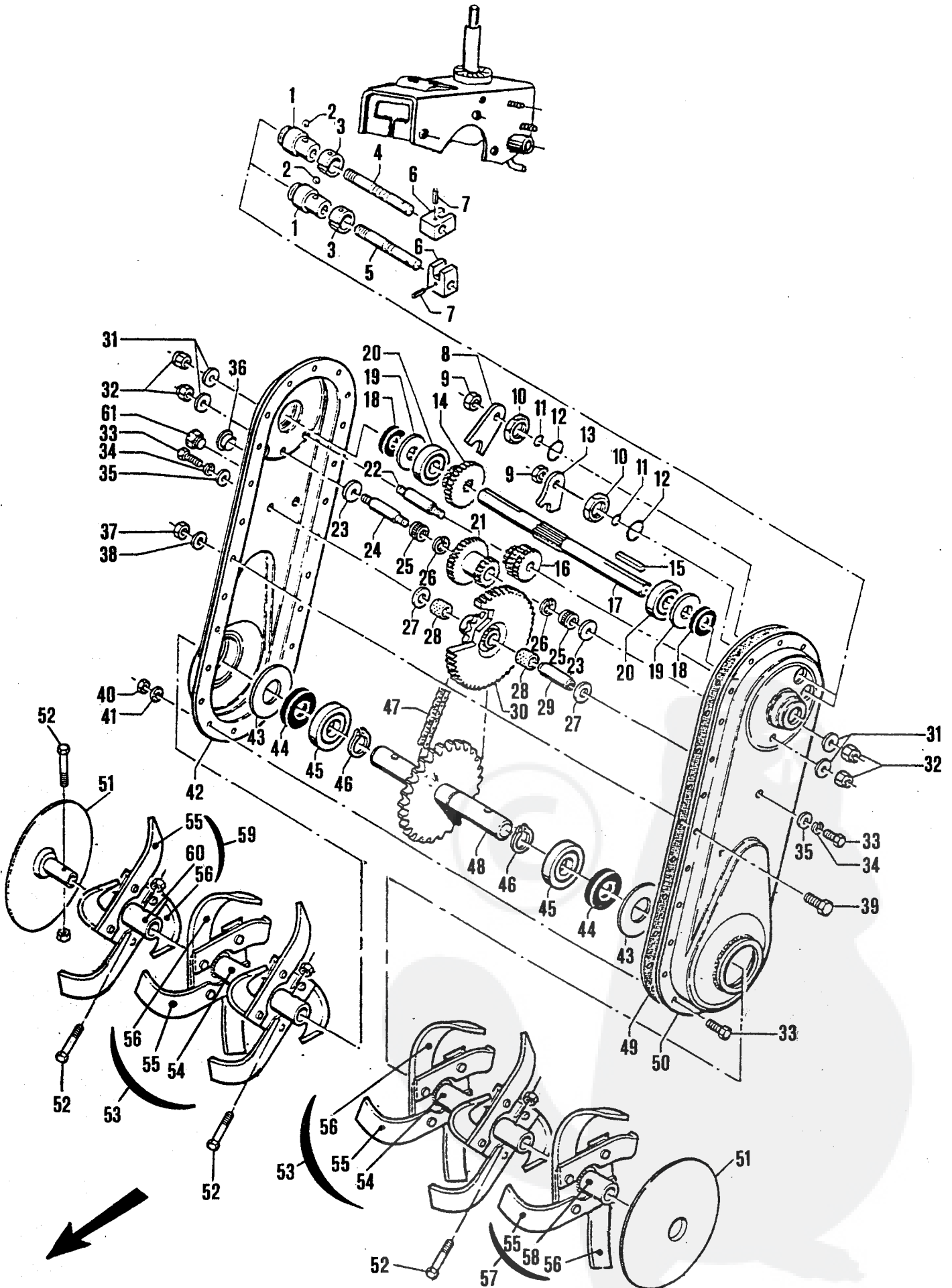

Fig.	Références	Désignation	Part Name	Bezeichnung	Descrizione	Descripcion	Designação	Omschrijving	Qté
1	34451	Palier	Fork bearing	Gabellager	Mozzo	Cojinete	Chumaceira	Naaf	2
2	34452	Bille	Ball bearing	Kugel	Sfere	Bola	Esfera	Kogel	2
3	34453	Bague	Spring	Flashleder	Molla	Ballesta	Mola	Veer	2
4	34454	Axe 1.2	Fork pin	Gabelachse	Astina	Eje de horquilla	Eixo	Wielas	1
5	34455	Axe Ar.	Fork pin	Gabelachse	Astina	Eje de horquilla	Eixo	Wielas	1
6	34456	Etrier	Fork U	U. Gabel	Leva	U de horquilla	Suporte	Steun	2
7	013.4.30	Goupille	Pin	Splint	Spina	Pasador	Pino	Borgpen	2
8	34408	Fourchette Ar.	Fork	Gabel	Settore	Horquilla	Garfo	Vork	1
9	34457	Ecrou	Nut	Mutter	Dado	Tuerca	Parafuso	Moer	2
10	34458	Ecrou	Nut	Mutter	Dado	Tuerca	Parafuso	Moer	2
11	34459	Joint	O. Ring	Wellendichtung	Anello di tenuta	Junta taroidal	Junta	Voeg	2
12	34460	Joint	O. Ring	Wellendichtung	Anello di tenuta	Junta tariodal	Junta	Voeg	2
13	34411	Fourchette 1.2	Fork	Gabel	Settore	Horquilla	Garfo	Vork	1
14	34484	Pignon	Pinion	Ritzel	Ingranaggio	Pinon	Pinhão	Tanrad	1
15	11006	Clavette	Key	Keil	Chiavetta	Clavigia	Pin	Pino	X
16	34461	Pignon	Pinion	Ritzel	Ingranaggio	Pinon	Pinhão	Tanrad	1
17	34462	Arbre	Shaft	Welle	Assale	Arbol	Eixo	Wielas	1
18	34463	Bague	Sealing washer	Dichtungsring	Rondella	Anilho junta	Anilha	Ring	2
19	34464	Rondelle	Washer	Scheibe	Rondella	Arandella	Anilha	Ring	2
20	34465	Roulement	Bearing	Kuggelager	Rodiamento	Cojinete	Rolamento	Kogellager	2
21	34466	Pignon	Pinion	Ritzel	Ingranaggio	Pinon	Pinhão	Tanrad	1
22	34467	Axe	Pin	Achse	Astina	Eje	Eixo	Wielas	1
23	34468	Rondelle	Washer	Scheibe	Rondella	Arandella	Anilha	Ring	2
24	34469	Axe	Pin	Achse	Astina	Eje	Eixo	Wielas	1
25	34470	Roulement	Bearing nedle	Nadellager	Rodiamento	Cujinete	Rolamento	Nadellager	2
26	34471	Circlips	Circlip	Clips	Seeger	Circlips	Anel	Circlip	2
27	34472	Rondelle	Washer	Scheibe	Rondella	Arandella	Anilha	Ring	2
28	34473	Bague	Friction ring	Reibungsring	Rondella	Anilho	Anilha	Ring	2
29	34474	Axe	Pin	Achse	Astina	Eje	Eixo	Wielas	1
30	34475	Pignon	Pinion	Ritzel	Ingranaggio	Pinon	Pinhão	Tanrad	1
31	Z08.M10U	Rondelle	Washer	Scheibe	Rondella	Arandella	Anilha	Ring	4
32	Z53.10	Ecrou	Nut	Mutter	Dado	Tuerca	Parafuso	Moer	4
33	Z03.8.16	Vis	Screw	Schraube	Vite	Tornillo	Parafuso	Schroef	32
34	009.8	Rondelle	Washer	Scheibe	Rondella	Arandella	Anilha	Ring	2
35	Z08.L8N	Rondelle	Washer	Scheibe	Rondella	Arandella	Anilha	Ring	2
36	34476	Bouchon	Plastic cap	Verschluß	Copri	Tapon	Tampao	Kunststofkap	1
37	Z11.10	Ecrou	Nut	Mutter	Dado	Tuerca	Parafuso	Moer	7
38	012.10AZ	Rondelle	Washer	Scheibe	Rondella	Arandella	Anilha	Ring	7
39	Z03.10.16	Vis	Screw	Schraube	Vite	Tornillo	Parafuso	Schroef	7
40	Z11.8	Ecrou	Nut	Mutter	Dado	Tuerca	Parafuso	Moer	15
41	012.8AZ	Rondelle	Washer	Scheibe	Rondella	Arandela	Anilha	Ring	16
42	34440	Carter D.	Transmission casing R.	Getriebhaue R.	Carter D.	Carter D.	Carter D.	Aandrijfkap R.	1
43	34477	Rondelle	Washer	Scheibe	Rondella	Arandela	Anilha	Ring	2
44	34478	Bague	Sealing washer	Dichtungsring	Rondella	Anilho junta	Anilha	Ring	2
45	34479	Roulement	Bearing	Kuggelager	Rodiamento	Cojinete	Rolamento	Kogellager	2
46	021.30	Circlips	Circlip	Clips	Seeger	Circlips	Anel	Circlip	2
47	34480	Chaine	Chain	Kette	Catena	Cadena	Cadeia	Ketting	1
48	34481	Arbre	Shaft	Welle	Arbero	Pinon	Arvore	Aandrijfas	1
49	34482	Joint	Casing seal	Gehäusedichtung	Paraolio	Junta carter	Junta	Voeg	1
50	34441	Carter G.	Transmission casing L.	Getriebehäuse L.	Carter	Carter I.	Carter E.	Aandrijfkap L.	1
51	34277	Disque p.plantes	Disc	Scheibe	Dischi	Disco	Disco	Schijf	2
52	Z04.10.40	Boulon	Screw	Schraube	Vite	Tornillo	Parafuso	Schroef	6
53	34267	Couronne	Hoe wheel	Kranz	Fresa	Corona	Coroa	Frees	2
54	34268	Moyeu	Hub	Nabe	Mozzo	Eje	Cubo de roda	Naaf	2
55	30950	Outil 40x4 D.	R/H Hoe tool	Werkzeug R.	Fresa Dx	Cuchilla D.	Ustensilio D.	Rechtermes	12
56	30951	Outil 40x4 G.	L/H Hoe tool	Werkzeug L.	Fresa Sx	Cuchilla I.	Ustensilio E.	Linkermes	12
57	34271	Couronne G.	L/H Hoe wheel	Kranz L.	Fresa Sx	Corona I.	Coroa E.	Linkerfrees	1
58	34273	Moyeu G.	Hub L/H	Nabe L.	Mozzo Sx	Eje I.	Cubo de coroa	Naaf	1
59	34270	Couronne D.	R/H Hoe wheel	Kranz R.	Fresa Dx	Corona D.	Coroa D.	Rechtenfrees	1
60	34272	Moyeu D.	Hub R/H	Nabe R.	Mozzo Dx	Eje D.	Cubo de coroa	Naaf	1
61	34483	Bouchon	Plug	Verschluß	Copri	Tapon	Tampao	Kunststofkap	1

Fig.	Réf.érences	Désignation	Part Name	Bezeichnung	Descrizione	Descripcion	Designação	Omschrijving	Qté
1	16706	Poignée	Handle	Sterzgriff	Manopola	Empunadura	Pega de rabiça	Handgreep	2
2	34243	Mancheron	Handlebar	Sterz	Manico	Manillar	Rabiça	Handgreep	1
3	Z53.5	Ecrou	Nut	Mutter	Dado	Tuerca	Parafuso	Moer	1
4	30407	Boitier	Plastic cap	Griffabdeckung	Copri	Tapon plastico	Tampao plastico	Kunststofkap	1
5	Z03.5.45	Vis	Screw	Schraube	Vite	Tornillo	Parafuso	Schroef	1
6	30525	Commande d'accélération	Throttle control	Gashebelgestange	Commando	Acceleratore	Accelerator	Gashebel	1
7	73112	Collier	Clip	Klemmschelle	Ferma cavo	Abrazadera	Gancho	Kabelbinder	2
8	11064	Bouchon	Plastic cap	Verschluß	Copri	Tapon plastico	Tampao plastico	Kunststofkap	1
9	Z42.12.120	Vis	Screw	Schraube	Vite	Tornillo	Parafuso	Schroef	1
10	30748	Ecrou	Nut	Mutter	Dado	Tuerca	Parafuso	Moer	2
11	34066	Bague	Spacer	Abstandsstücke	Distanziale	Distanciador	Separador	Afstandsstuk	1
12	34070	Potence	Bracket	Träger	Supporto	Sosten manillar	Quadro	Juk	1
13	34231	Calandre	Plastic cap	Verschluß	Copri	Embellecedor	Calote	Dop	1
14	34357	Levier	Lever clutch	Kupplungsgriff	Manopola	Maneta	Alavanca	Koppelingshendel	1
15	42032	Collier	Clip	Klemmschelle	Ferma cavo	Abrazadera	Gancho	Kabelbinder	2
16	34232	Timonerie	Clutch control	Gestange	Cavo semovenza	Mando de embrague	Commando	Koppelingsstang	1
17	10661	Poignée	Lever handle	Hebelgriff	Capucha	Tapon plastico	Tampao plastico	Kunststofkap	1
18	34244	Levier	Lever	Schalthebel	Leva	Palanca	Hevel	Braco	1
19	013.4.30	Goupille	Pin	Splint	Spina	Pasador	Pino	Borgpen	2
20	34234	Support	Support	Träger	Supporto	Soporte	Suporte	Steun	1
21	Z04.10.130	Boulon	Screw	Schraube	Vite	Tornillo	Parafuso	Schroef	2
22	Z04.10.120	Boulon	Screw	Schraube	Vite	Tornillo	Parafuso	Schroef	1
23	Z11.6	Ecrou	Nut	Mutter	Dado	Tuerca	Parafuso	Moer	2
24	34062	Grille de vitesses	Support	Träger	Supporto	Soporte	Suporte	Steun	1
25	34055	Doigt de vitesses	Gear finger	Antriebswelle	Astina	Arbal primario	Eixo	Wiel	1
26	11078	Pivot	Axle	Achse	Astina	Eje	Eixo	Wielas	1
27	062.RS.12	Circlips	Circlip	Clips	Seeger	Circlips	Anel	Circlip	2
28	11006	Clavette	Key	Splint	Chiavetta	Clavigia	Pino	Pin	1
29	34045	Support de potence	Support	Träger	Supporto	Soporte	Suporte	Steun	1
30	34022	Entretoise	Spacer	Anstandschüle	Distanziale	Distanciador	Separador	Afstandsbruis	8
31	34251	Carter	Carter	Carter	Scocca	Carter	Carter	Aandrijfkap	1
32	11264	Chevile	Axle	Achse	Astina	Eje	Eixo	Wielas	1
33	34256	Support	Support	Träger	Supporto	Soporte	Suporte	Steun	1
34	30615	Clé de blocage	Pin	Schlüssel	Vite	Tornillo	Chave	Borghevel	1
35	34257	Eperon	Leg	Stutze	Puntone	Espolon	Apaió	Spoortstang	1
36	025.6.12	Vis	Screw	Schraube	Vite	Tornillo	Parafuso	Schroef	1
37	34028	Poulie	Pulley	Treibrad	Puleggia	Polea	Polia	Riemschijf	1
38	34229	Courroie	Belt	Riemen	Cinghia	Correa	Correia	Riem	1
39	34235	Capot	Cover	Riemenhaube	Coperchio	Capo	Cobertura	Kap	1
40	Z03.6.16	Vis	Screw	Schraube	Vite	Tornillo	Parafuso	Schroef	1
41	Z12.6AZ	Rondelle	Washer	Scheibe	Rondella	Arandela	Anilha	Ring	1
42	Z08.L6N	Rondelle	Washer	Scheibe	Rondella	Arandela	Anilha	Ring	1
43	Z03.5.30	Vis	Screw	Schraube	Vite	Tornillo	Parafuso	Schroef	2
44	Z08.L5N	Rondelle	Washer	Scheibe	Rondella	Arandela	Anilha	Ring	2
45	Z12.5AZ	Rondelle	Washer	Scheibe	Rondella	Arandela	Anilha	Ring	2
46	34027	Poulie	Pulley	Treibrad	Puleggia	Polea	Polia	Riemschijf	1
47	052.8.8	Vis	Screw	Schraube	Vite	Tornillo	Parafuso	Schroef	1
48	Z03.792416	Vis	Screw	Schraube	Vite	Tornillo	Parafuso	Schroef	2
49	34233	Guide-courroie	Veebelt guide	Riemenführung	Guida cinghia	Guia de correia	Guia de correia	Drifriemgeleider	1
50	062.RS.9	Circlips	Circlip	Clips	Seeger	Circlips	Anel	Circlip	2
51	Z03.10.20	Vis	Screw	Schraube	Vite	Tornillo	Parafuso	Schroef	1
52	11030	Galet	Tensioner wheel	Riemenspannrolle	Puleggia	Polea	Polia	Rol	1
53	Z03.8.55	Vis	Screw	Schraube	Vite	Tornillo	Parafuso	Schroef	4
54	16667	Goupille	Pin	Splint	Coppoglia	Pasador	Cavilha	Borgpen	2
55	16245	Entretoise	Spacer	Abstandshüle	Distanziale	Distanciador	Separador	Afstandsstuk	4
56	34242	Chassis	Frame	Rhamen	Chassis	Chasis	Chassis	Chassis	1
57	Z53.8	Ecrou	Nut	Mutter	Dado	Tuerca	Parafuso	Moer	10
58	30557	Bras de galet	Arm	Vorrichtung	Leva	Leva	Braço	Rolarm	1
59	Z08.L8N	Rondelle	Washer	Scheibe	Rondella	Arandela	Anilha	Ring	14
60	34237	Patte	Support	Trager	Supporto	Soporte	Suporte	Steun	2
61	Z04.10.70	Boulon	Screw	Schraube	Vite	Tornillo	Parafuso	Schroef	4
62	Z03.8.20	Vis	Screw	Schraube	Vite	Tornillo	Parafuso	Schroef	6
63	34238	Capot d'outils D.	Stone guard R.	Werkzeug Haube R.	Protezione Dx	Capot D.	Capot D.	Kapo R.	1
	34239	Capot d'outils G.	Stone guard L.	Werkzeug Haube L.	Protezione Sx	Capot I.	Capot E.	Kapo L.	1
64	30563	Ressort	Spring	Feder	Molla	Muelle	Mola	Veer	1
65	34246	Chevile	Pin	Splint	Perno	Pasador	Cavilha	Borgpen	2
66	34261	Fourche	Fork	Radgabe	Supporto	Horquilla	Forquilha	Vork	1
67	Z03.10.80	Vis	Screw	Schraube	Vite	Tornillo	Parafuso	Schroef	1
68	Z53.10	Ecrou	Nut	Mutter	Dado	Tuerca	Parafuso	Moer	1
69	30601	Roue	Wheel	Rad	Ruota	Rueda	Roda	Wiel	1
70	30602	Coussinet	Spacer	Anstandshüle	Distanziale	Distanciador	Separador	Afstandsstuk	1
71	Z03.6.10	Vis	Screw	Schraube	Vite	Tornillo	Parafuso	Schroef	12
72	Z53.6	Ecrou	Nut	Mutter	Dado	Tuerca	Parafuso	Moer	12
73	33879	Extension G.	Extension L.	Verbreiterung L.	Estensione S.	Estencion I.	Extensão E.	Extra L spatbord	1
	33880	Extension D.	Extension R.	Verbreiterung R.	Estensione D.	Estencion D.	Extensão D.	Extra R spatbord	1
74	34264	Extension D/G	Extension R/L	Verbreiterung R/L	Estensione D/S	Estencion D/I	Extensão D/E	Extra R/L spatbord	2
75	31530	Cache-écrou	Plastic cap	Mutterabdeckung	Copri	Tapon plastico	Tampão plastico	Kunststofkap	5
76	31529	Cache-écrou	Plastic cap	Mutterabdeckung	Copri	Tapon plastico	Tampão plastico	Kunststofkap	3
77	31494	Cache-écrou	Plastic cap	Mutterabdeckung	Copri	Tapon plastico	Tampão plastico	Kunststofkap	13
78	34358	Levier	Lever clutch	Kupplungsgriff	Manopola	Maneta	Alavanca	Koppelingshendel	1
79	30429	Contacteur	Interruptor	Schalter	Interruttore	Interruptor	Interrutor	Schakelaar	1
80	34104	Timonerie	Decoupling cable	Gestange	Cavo	Cable	Commando	Koppelingsstang	2
81	34102	Raccord	Coupling	Mutter	Dado	Tuerca	Parafuso	Moer	2

Motobineuse avec débrayage / Tiller with Claw Decoupling
Motobinadora con desembrague / Motorhacke mit Klauenkupplung

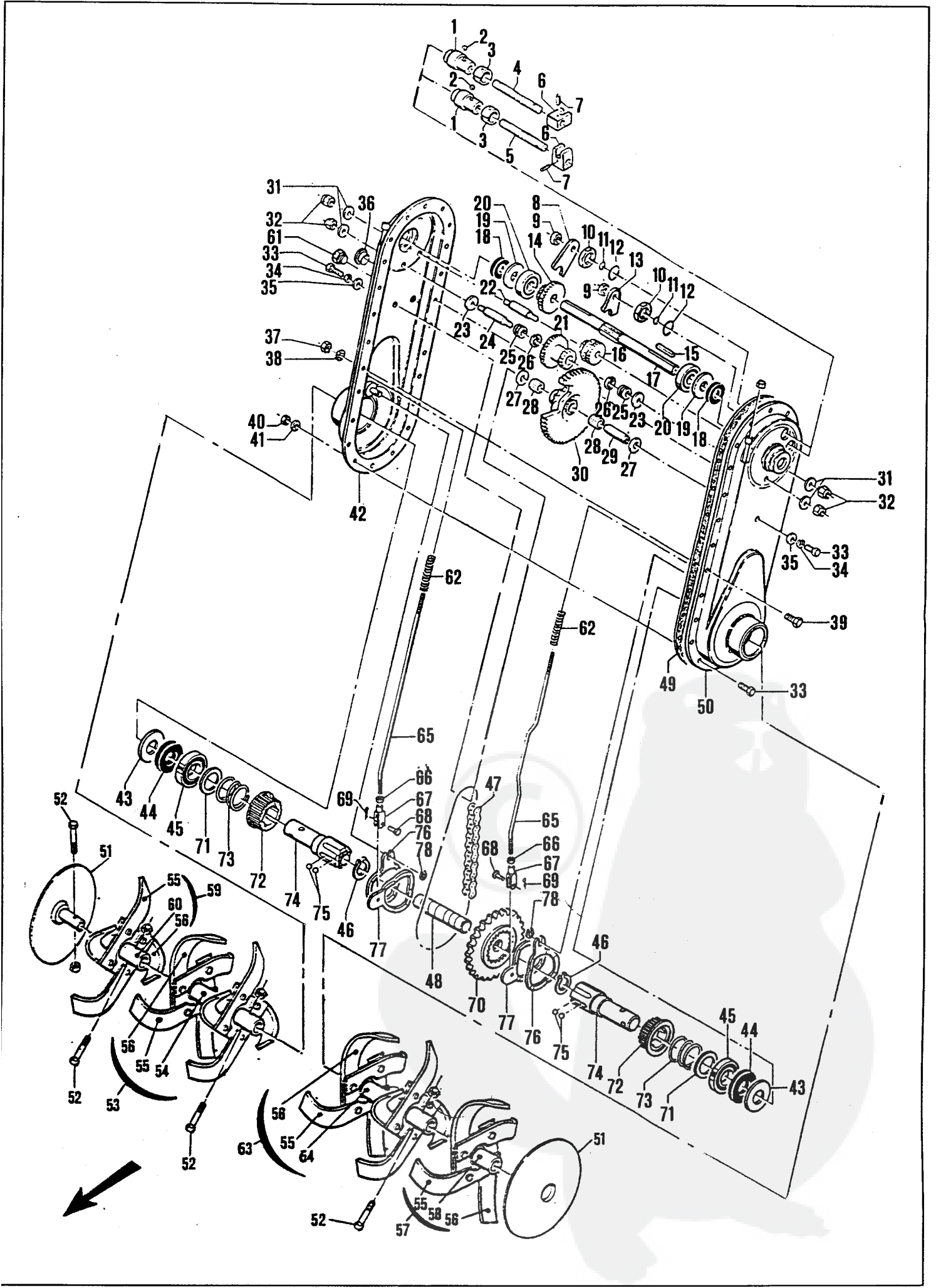

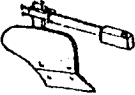
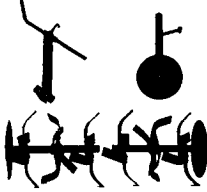

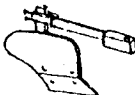
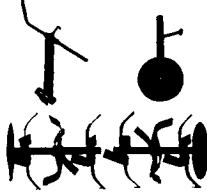

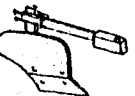
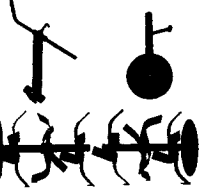



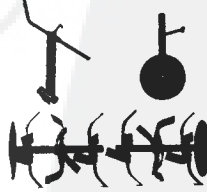





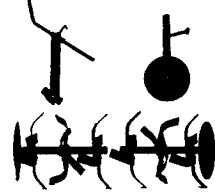

Fig.	Références	Désignation	Part Name	Bezeichnung	Descrizione	Descripción	Designação	Omschrijving	Qté
1	34451	Palier	Fork bearing	Gabellager	Mozzo	Cojinete	Chumaceira	Naaf	2
2	34452	Bille	Ball bearing	Kugel	Sfere	Bola	Esfera	Kogel	2
3	34453	Bague	Spring	Flashleder	Molla	Ballesta	Mola	Veer	2
4	34454	Axe 1.2	Fork pin	Gabelachse	Astina	Eje de horquilla	Eixo	Wielas	1
5	34455	Axe Ar.	Fork pin	Gabelachse	Astina	Eje de horquilla	Eixo	Wielas	1
6	34456	Etrier	Fork U	U. Gabel	Leva	U de horquilla	Suporte	Steuern	2
7	013.4.30	Goupille	Pin	Splint	Spina	Pasador	Pino	Borgpen	2
8	34408	Fourchette Ar.	Fork	Gabel	Settore	Horquilla	Garfo	Vork	1
9	34457	Ecrou	Nut	Mutter	Dado	Tuerca	Parafuso	Moer	2
10	34458	Ecrou	Nut	Mutter	Dado	Tuerca	Parafuso	Moer	2
11	34459	Joint	O. Ring	Wellendichtung	Anello di tenuta	Junta taroidal	Junta	Voeg	2
12	34460	Joint	O. Ring	Wellendichtung	Anello di tenuta	Junta tariodal	Junta	Voeg	2
13	34411	Fourchette 1.2	Fork	Gabel	Settore	Horquilla	Garfo	Vork	1
14	34484	Pignon	Pinion	Ritzel	Ingranaggio	Pinon	Pinhão	Tanrad	1
15	11006	Clavette	Key	Keil	Chiavetta	Clavigia	Pin	Pino	X
16	34461	Pignon	Pinion	Ritzel	Ingranaggio	Pinon	Pinhão	Tanrad	1
17	34462	Arbre	Shaft	Welle	Assale	Arbol	Eixo	Wielas	1
18	34463	Bague	Sealing washer	Dichtungsring	Rondella	Anilho junta	Anilha	Ring	2
19	34464	Rondelle	Washer	Scheibe	Rondella	Arandella	Anilha	Ring	2
20	34465	Roulement	Bearing	Kuggelager	Rodiamento	Cojinete	Rolamento	Kogellager	2
21	34466	Pignon	Pinion	Ritzel	Ingranaggio	Pinon	Pinhão	Tanrad	1
22	34467	Axe	Pin	Achse	Astina	Eje	Eixo	Wielas	1
23	34468	Rondelle	Washer	Scheibe	Rondella	Arandella	Anilha	Ring	2
24	34469	Axe	Pin	Achse	Astina	Eje	Eixo	Wielas	1
25	34470	Roulement	Bearing nedle	Nadellager	Rodiamento	Cujinete	Rolamento	Nadellager	2
26	34471	Circlips	Circlip	Clips	Seeger	Circlips	Anel	Circlip	2
27	34472	Rondelle	Washer	Scheibe	Rondella	Arandella	Anilha	Ring	2
28	34473	Bague	Friction ring	Reibungsring	Rondella	Anilho	Anilha	Ring	2
29	34474	Axe	Pin	Achse	Astina	Eje	Eixo	Wielas	1
30	34475	Pignon	Pinion	Ritzel	Ingranaggio	Pinon	Pinhão	Tanrad	1
31	Z08.M10U	Rondelle	Washer	Scheibe	Rondella	Arandella	Anilha	Ring	4
32	Z53.10	Ecrou	Nut	Mutter	Dado	Tuerca	Parafuso	Moer	4
33	Z03.8.16	Vis	Screw	Schraube	Vite	Tornillo	Parafuso	Schroef	32
34	009.8	Rondelle	Washer	Scheibe	Rondella	Arandella	Anilha	Ring	2
35	Z08.L8N	Rondelle	Washer	Scheibe	Rondella	Arandella	Anilha	Ring	2
36	34476	Bouchon	Plastic cap	Verschluß	Copri	Tapon	Tampao	Kunststofkap	1
37	Z11.10	Ecrou	Nut	Mutter	Dado	Tuerca	Parafuso	Moer	7
38	012.10AZ	Rondelle	Washer	Scheibe	Rondella	Arandella	Anilha	Ring	7
39	Z03.10.16	Vis	Screw	Schraube	Vite	Tornillo	Parafuso	Schroef	7
40	Z11.8	Ecrou	Nut	Mutter	Dado	Tuerca	Parafuso	Moer	15
41	012.8AZ	Rondelle	Washer	Scheibe	Rondella	Arandella	Anilha	Ring	16
42	34429	Carter D.	Transmission casing R.	Getriebhaue R.	Carter D.	Carter D.	Carter D.	Aandrijfkap R.	1
43	34477	Rondelle	Washer	Scheibe	Rondella	Arandella	Anilha	Ring	2
44	34478	Bague	Sealing washer	Dichtungsring	Rondella	Anilho junta	Anilha	Ring	2
45	34479	Roulement	Bearing	Kuggelager	Rodiamento	Cojinete	Rolamento	Kogellager	2
46	021.30	Circlips	Circlip	Clips	Seeger	Circlips	Anel	Circlip	2
47	34480	Chaîne	Chain	Kette	Catena	Cadena	Cadeia	Ketting	1
48	34485	Arbre	Shaft	Welle	Arbero	Pinon	Arvore	Aandrijfas	1
49	34482	Joint	Casing seal	Gehäusedichtung	Paraolio	Junta carter	Junta	Voeg	1
50	34430	Carter G.	Transmission casing L.	Getriebehäuse L.	Carter	Carter I.	Carter E.	Aandrijfkap L.	1
51	34342	Disque p.plantes	Disc	Scheibe	Dischi	Disco	Disco	Schijf	2
52	Z04.10.50	Boulon	Screw	Schraube	Vite	Tornillo	Parafuso	Schroef	6
53	34334	Couronne D.	Hoe wheel R.	Kranz R.	Fresa Dx	Corona D.	Coroa D.	Frees R.	2
54	34332	Moyeu D.	Hub R.	Nabe R.	Mozzo Dx	Eje D.	Cubo de roda D.	Naaf R.	2
55	30950	Outil 40x4 D.	R/H Hoe tool	Werkzeug R.	Fresa Dx	Cuchilla D.	Ustensilio D.	Rechtermes	12
56	30951	Outil 40x4 G.	L/H Hoe tool	Werkzeug L.	Fresa Sx	Cuchilla I.	Ustensilio E.	Linkermes	12
57	34347	Couronne G.	L/H Hoe wheel	Kranz L.	Fresa Sx	Corona I.	Coroa E.	Linkerfrees	1
58	34343	Moyeu G.	Hub L/H	Nabe L.	Mozzo Sx	Eje I.	Cubo de coroa	Naaf	1
59	34346	Couronne D.	R/H Hoe wheel	Kranz R.	Fresa Dx	Corona D.	Coroa D.	Rechtenfrees	1
60	34344	Moyeu D.	Hub R/H	Nabe R.	Mozzo Dx	Eje D.	Cubo de coroa	Naaf	1
61	34483	Bouchon	Plug	Verschluß	Copri	Tapon	Tampao	Kunststofkap	1
62	34486	Ressort	Spring	Feder	Molla	Muelle	Mola	Veer	2
63	34333	Couronne G.	Hoe wheel L.	Kranz L.	Fresa Sx	Corona I.	Coroa E.	Frees L.	1
64	34337	Moyeu G.	Hub L.	Nabe L.	Mozzo Sx	Eje I.	Cubo de roda E.	Naaf L.	1
65	34487	Tirant	Bar	Stange	Tirante	Barra	Barra	Framebalk	2
66	Z11.6	Ecrou	Nut	Mutter	Dado	Tuerca	Parafuso	Moer	2
67	34488	Chape	Fork U	U. Gabel	Leva	U de horquilla	Suporte	Steuern	2
68	34489	Axe	Axle	Achse	Astina	Eje	Eixo	Wielas	2
69	34490	Goupille	Pin	Splint	Spina	Pasador	Pino	Sorgpen	2
70	34431	Pignon	Pinion	Ritzel	Ingranaggio	Pinon	Pinhão	Tanrad	2
71	34491	Rondelle	Washer	Scheibe	Rondella	Arandella	Anilha	Ring	2
72	34492	Crabot	Clutch claw	Klame	Ingranaggio	Enganche	Pinhão	Tanrad	2
73	34493	Ressort	Spring	Feder	Molla	Muelle	Mola	Verr	2
74	34494	1/2 Arbre	1/2 Shaft	1/2 Welle	1/2 Albero	1/2 Eje	1/2 Arvore	1/2 Aandrijfas	2
75	34495	Bille	Ball-bearing	Kugel	Sfere	Bola	Esfera	Kogel	12
76	34496	Came	Cam	Nacke	Leva	Leva	Alavanca	Hevel	2
77	34497	Came	Cam	Nacke	Leva	Leva	Alavanca	Hevel	2
78	34498	Circlips	Circlip	Clips	Seeger	Circlips	Anel	Circlip	2





ACCESSOIRES ADAPTABLES		
34211		Brabant 1/2 tour
34212		Charrue simple
34255		Equipement 6 fraises Roue - Disque protège-plantes Eperon - S 800 - ø 25
34330		Equipement 6 fraises Roue - Disque protège-plantes Eperon - S 802 - ø 30
34260		Equipement moyeux semi-différentiel avec masses de roues et masse avant S 800 - ø 25
34350		Equipement moyeux avec masses de roues et masse avant S 802 - ø 30



OPTIONAL ACCESSORIES		
34211		1/2 rev. plough
34212		Single plough
34255		Attachment 6 Hoe wheel Front wheel - Plant guard disks Leg - S 800 - ø 25
34330		Attachment 6 Hoe wheel Front wheel - Plant guard disks Leg - S 802 - ø 30
34260		Attachment Hubs with solid part of wheel and counter weight S 800 - ø 25
34350		Attachment Hubs with solid part of wheel and counter weight S 802 - ø 30

ADAPTIERBARE ZUBERHÖRTEILE		
34211		1/2 Dreh-Karrenpflug
34212		Beetpflug
34255		Anstattung 6 Fräsen Rad - Pflanzenschutzscheiben Schütze - S 800 - ø 25
34330		Anstattung 6 Fräsen Rad - Pflanzenschutzscheiben Schütze - S 802 - ø 30
34260		Anstattung Mitnehmernaben mit Radmassen und Frontgewicht S 800 - ø 25
34350		Anstattung Naben mit Radmassen und Frontgewicht S 802 - ø 30

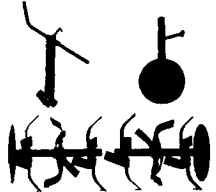
ACCESSORI ADATTABILI		
34211		Aratro 1/2 giro (Brabant)
34212		Aratro semplice
34255		Attrezzatura 6 Fresa Ruota - Dischi oi protezione Puntone - S 800 - ø 25
34330		Attrezzatura 6 Fresa Ruota - Dischi oi protezione Puntone - S 802 - ø 30
34260		Attrezzadura mozzi semi-differenziali con masse di ruote e massa anteriore - S 800 - ø 25
34350		Attrezzadura mozzi con masse di ruote e massa anteriore S 802 - ø 25

ACCESORIOS ADAPTABLES		
34211		Arado 1/2 vuelta (arado metallico)
34212		Arado simple
34255		Equipamiento 6 Coronas Rueda - Disco - Espolon S 800 - ø 25
34330		Equipamiento 6 Coronas Rueda - Disco - Espolon S 802 - ø 30
34260		Equipamiento cubos semidiferenciales con masas de ruedas y masa delantera - S 800 - ø 25
34350		Equipamiento cubos con masas de ruedas y masa delantera S 802 - ø 30

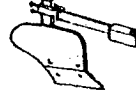
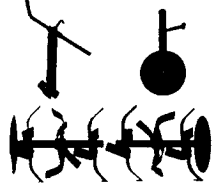
AANPASBARE ACCESSOIRES		
34211		Ploeg 1/2 slaag (Brabant)
34212		Enkelvoudige ploeg
34255		Uitrusting 6 Frees Wiel - Schijf - Spoorstang S 800 - ø 25
34330		Uitrusting 6 Frees Wiel - Schijf - Spoorstang S 802 - ø 30
34260		Iustrusting halfdifferential-naven met wielmassen en voormassa S 800 - ø 25
34350		Iustrusting naven met wielmassen en voormassa S 802 - ø 30

ACCESSORIOS ADAPTAVEIS		
34211		Charrua 1/2 volta (Brabant)
34212		Charrua silmples
34255		Equipamento 6 Coroas Roda - Disco - Apoio S 800 - ø 25
34330		Equipamento 6 Coroas Roda - Disco - Apoio S 802 - ø 30
34260		Equipamento de transporte semi-diferencias, com massas de rodas e masse à frente S 800 - ø 25
34350		Equipamento de transporte com massas de rodas e masse à frente S 802 - ø 30

