

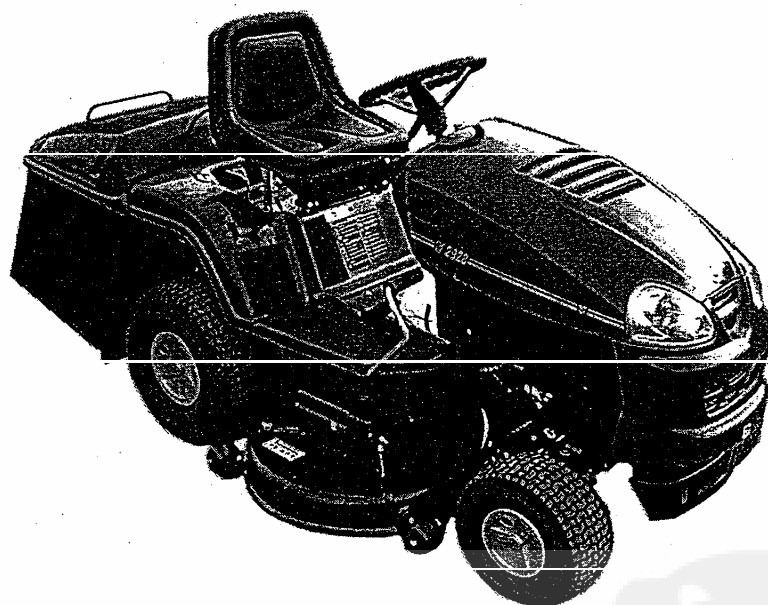

W-2500 OPERATOR'S MANUAL

With Advanced Maintenance Instructions



12 / 01

WISCONSIN ENGINEERING CZ S.R.O.

Vrahovicka 41
796 01 Prostejov
Czech Republic
Tel: ++420 582 401 913
Fax: ++420 582 401 919
E-mail: info@wisconsineng.cz
Internet: www.wisconsineng.com

Attachments and Accessories W-2000 Variomatic Series

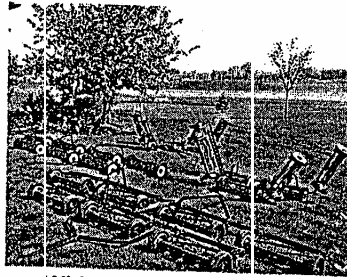
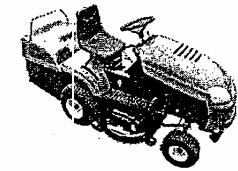

Wide Area Gang Mowers

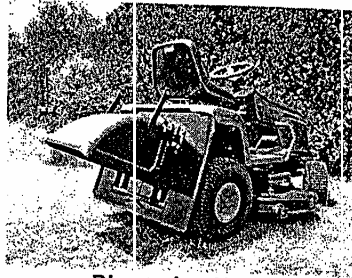

Dispersing Hood

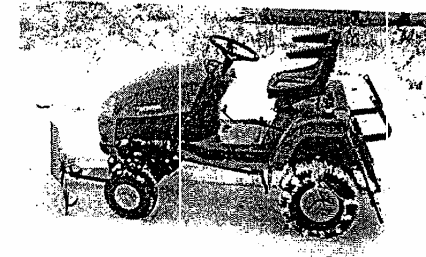

Snow Kit:

- Blade Rubber Edge
- Snow Chains

ALSO AVAILABLE:

- 40" (102 cm) Side Discharge Deck
- Battery Conditioner for Extended Storage
- Aerating Roller
- Broadcast Spreader

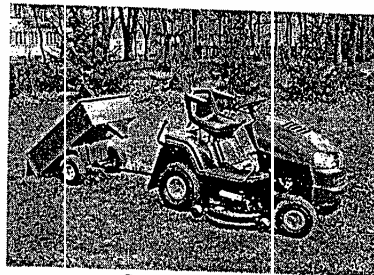

Cargo Trailer

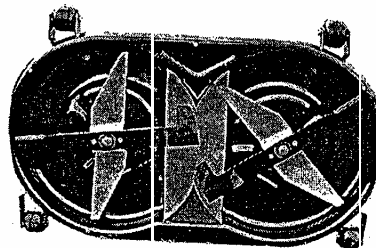

Mulching Kit

WISCONSIN ENGINEERING CZ S.R.O.

Vrahovicka 41
796 01 Prostejov
Czech Republic

Tel.: ++420 582 401 910

Fax: ++420 582 401 919

E-mail: info@wisconsineng.cz

Internet: www.wisconsineng.com

TABLE OF CONTENTS

INTRODUCTION	3	OPERATING	16
CONGRATULATIONS	3	FILLING FUEL TANK	16
USING YOUR OPERATOR'S MANUAL	3	PRESTART	16
DISCLAIMER	3	STARTING THE ENGINE	16
DELIVERY	3	DRIVING THE TRACTOR TO AND FROM THE WORK AREA	16
UNAUTHORIZED REPLACEMENT PARTS	3	MOWING.....	16
SPECIAL MESSAGES	3	<i>Using FBS System</i>	16
WARRANTY AND SERVICE INFORMATION	4	SLOPE OPERATION	17
SAFETY	5	GRASS CONTAINER OPERATION.....	17
SIGNAL WORDS & SAFETY ALERTS	5	<i>Manual Units</i>	17
NOTATIONS	5	<i>PowerBag Units</i>	17
EQUIPMENT SAFETY GUIDELINES	5	<i>Installing and Removing Grass Container</i>	17
SAFETY SHIELDS AND LABELS.....	5	<i>Simplified PowerBag Collector Installation</i>	17
<i>Safety Decals – Maintenance and Replacement</i>	6	MOVING THE UNIT MANUALLY	17
<i>Safety Decals – Installing</i>	6	SHUT OFF	18
LEARN SAFE PRACTICES AND APPLICABLE LAWS.....	6	<i>Emergency Shut-Off</i>	18
OPERATOR TRAINING IS REQUIRED	6	<i>Normal Shut-Off</i>	18
ASSEMBLY SAFETY	6	MOWING HINTS.....	18
OPERATIONAL SAFETY	6	ATTACHMENTS.....	18
WORK AREA.....	7	CLEANING AND STORING	19
DRUGS AND ALCOHOL	7	CLEANING	19
CHILDREN AND ANIMALS.....	7	WASHING	19
PASSENGERS	7	STORING	19
STARTING AND STOPPING SAFELY.....	7	EXTENDED/SEASONAL STORAGE.....	19
PERSONAL SAFETY	7	MAINTENANCE, SERVICE, AND ADJUSTMENTS	20
WEAR APPROPRIATE CLOTHING & SAFETY GEAR.....	7	UNIT IDENTIFICATION & TECHNICAL SERVICE	20
OPERATING SAFELY	8	SERVICE POSITION.....	20
SLOPE OPERATION	8	CHECK SAFETY INTERLOCK SYSTEM	20
MOWER SAFETY	8	CHECK FASTENERS.....	20
TRANSPORTING SAFELY	9	ENGINE SERVICE	20
PARKING SAFELY	9	<i>Engine Oil Change</i>	20
SERVICE AND MAINTENANCE	9	<i>Oil Filter, Air Filters, and Other Engine Service</i>	20
<i>Tire Safety</i>	9	POWER BAG LIFT	20
<i>Fuel Hazards</i>	10	BULB REPLACEMENT.....	20
<i>Battery Maintenance</i>	10	BLADE REPLACEMENT.....	20
PREVENT FIRES.....	10	BATTERY	21
ACCESSORY AND ATTACHMENT SAFETY	10	<i>Clean Battery</i>	21
WASTE PRODUCTS AND CHEMICALS.....	10	<i>Electrolyte Level</i>	21
PREPARATION BEFORE OPERATION	11	STEERING	21
PACKAGE CONTENTS:.....	11	<i>Adjusting Freeplay</i>	21
SEAT	11	<i>Aligning Steering Wheel and Front Wheels</i>	21
<i>Install Seat</i>	11	WHEEL REPLACEMENT	21
<i>Adjust Seat</i>	11	TIRE PRESSURE.....	21
INSTALL STEERING WHEEL	11	DISCHARGE CHUTE	21
FUELING AND ENGINE SERVICE.....	11	FULL BAG DETECTOR.....	21
TIRE INFLATION.....	11	BELTS.....	22
BLADES.....	12	DRIVE BELT	22
BELTS.....	12	<i>Checking Drive Belt Tension</i>	22
ANTI-SCALPING CASTERS.....	12	<i>Adjusting Drive Belt Tension</i>	22
COLLECTION BIN	12	<i>Changing Drive Belt</i>	22
<i>Manual Lift Units</i>	12	MOWING DECK TIMING BELT.....	22
<i>Power Bag Units</i>	12	<i>Correct Tensions:</i>	23
REMOVING PROTECTIVE FOIL	12	<i>Adjusting Tension</i>	23
CONTROLS	13	BELT TENSION GAUGE	23
CONTROLS AND LAYOUT OVERVIEW	13	MOWING DECK	23
DESCRIPTION OF CONTROLS	13	<i>Removing</i>	23
<i>Drive Pedal</i>	13	<i>Adjusting Deck Pitch (Front to Back)</i>	23
<i>Transmission Bypass Valve</i>	13	<i>Adjusting Deck Level (Side-to-Side)</i>	23
<i>Brake Pedal</i>	13	<i>Mowing Deck Lift Adjustment</i>	23
<i>Parking Brake</i>	13	<i>Anti-Scalp Rollers</i>	24
<i>Deck Height Adjustment</i>	14	MOWING BLADES.....	24
<i>Throttle</i>	14	<i>Mowing Blade Removal</i>	24
<i>Choke</i>	14	<i>Sharpening Blades</i>	24
<i>Ignition Switch</i>	14	<i>Balancing Blades</i>	24
<i>PTO Switch</i>	14	<i>Installing 40"(102 cm) Deck Blades</i>	24
<i>Automatic Mode Reset Switch</i>	14	<i>Installing 48"(122 cm) Deck Blades</i>	24
<i>Automatic/Manual Mode Control Switch</i>	14	GRASS COLLECTOR	25
<i>Collector Dump Switch</i>	14	<i>Adjusting Alignment</i>	25
CONTAINER LOCK LEVER.....	14	HYDROSTATIC TRANSAXLE	25
INDICATOR LIGHTS.....	14	<i>Controlling Hydrostatic Oil</i>	25
<i>Ignition Indicator</i>	14	<i>Adjusting Transaxle Brake</i>	25
<i>Blade Engagement Indicator</i>	14	<i>Adjusting Transaxle Neutral Setting</i>	25
<i>Parking Brake Indicator</i>	14	<i>Adjusting Transaxle Bypass Valve Engagement</i>	26
<i>Full Bag Indicator</i>	14	LUBRICATION	26
<i>Engine Hour Meter</i>	14	MAINTENANCE CHART	26
FULL BAG SHUTOFF SYSTEM	15	TROUBLESHOOTING GUIDE	28
<i>Using the Full Bag Detection System</i>	15	TECHNICAL SPECIFICATIONS	30
SAFETY INTERLOCK SYSTEM (SIS).....	15		

INTRODUCTION

CONGRATULATIONS

Thank You for purchasing a Wisconsin Engineering Product. You have purchased one of the finest, most advanced lawn tractors available.

We appreciate your business and wish you many years of safe and satisfied use of your machine. Our main objective was to provide you with a safe, hard working, and reliable tractor that will give you years of service. Once you have had the opportunity to use your new machine, we believe you will agree we have accomplished our goal.

USING YOUR OPERATOR'S MANUAL



Read, Understand, and Follow the Messages in this Manual - doing so will promote safe, productive, and reliable service.

This manual was prepared to help you properly use, service, and maintain your new investment and to operate it safely. Reading your operator's manual will help you and others avoid personal injury or damage to the machine. Read this manual carefully before operating your new tractor - information given in this manual will provide the operator with the safest and most effective use of the machine.

Pay close attention to all cautions and warnings in this text. This machine can cause serious property damage, personal injury, or even death if it is misused. For your safety, as well as the safety of bystanders, you must follow the safety precautions in this operator's manual.

This manual is an important part of your machine. It should remain with the machine if and when it is sold. If it is damaged or lost, contact your dealer, or Wisconsin Engineering at ++420 (0) 508 313 301 or www.wisconsineng.com to get a replacement.

In order to provide a better view, certain photographs or illustrations in this manual may show the machine or an assembly with a safety shield removed. However, equipment should never be operated in this condition. Keep all shields in place. If shield removal becomes necessary for repairs, replace the shield prior to use.

All reference to left, right, front, and rear are given from the operator sitting in operation position and facing the direction of forward travel.

Before delivering this machine, your dealer performed a pre-delivery inspection to ensure best performance.

DISCLAIMER

Wisconsin Engineering's policy is one of continuous improvements - we are continually striving to improve our product to bring you the best value. As a result, you may notice some slight differences between your machine and the technical illustrations in the manual. However, these differences are slight and do not change the instructions, recommendations, and warnings presented in this text. Some equipment described within this manual may be optional. Some illustrations and descriptions may not be applicable to your unit. All data given in this book is subject to production variations, and were in effect at the time of printing. Dimensions and weights are approximate only and the illustrations do not necessarily show tractors in the standard condition. For exact information about any particular tractor, please contact Wisconsin Engineering. The right to change prices, specification, or equipment at any time without public notice or obligation, is reserved.

DELIVERY

Notice to Customers: If you have purchased this product without complete assembly and instructions by your dealer, it is your responsibility to:

Read and understand all assembly instructions in this manual. If you do not understand or have difficulty following the instructions, contact

your tractor dealer for assistance. Make sure all assembly has been properly completed and safety interlock system works properly.

NOTE: To locate your nearest Wisconsin Engineering tractor dealer, call ++420 (0) 508 330 301 or visit www.wisconsineng.com on the internet.

WARNING! Improper assembly or adjustments can cause serious injury or damage to the machine.

The operator must:

1. Understand all Safety Precautions provided in the manuals
2. Review control functions and operation of the unit. Do not operate machine unless all controls function as described in this manual.
3. Review recommended lubrication, maintenance, and adjustments.
4. Fill out original Purchaser Registration Card and return the card to Wisconsin Engineering.

UNAUTHORIZED REPLACEMENT PARTS

Use only Wisconsin Engineering replacement parts. The replacement of any part on this vehicle with anything other than a Wisconsin Engineering authorized replacement part may adversely affect the performance, durability, or safety of this unit and may void the warranty. Wisconsin Engineering disclaims liability for any claims or damages, whether warranty, property damage, personal injury or death arising out of the use of unauthorized replacement parts. For a brief list of replacement parts see *Service Parts* in this manual. To obtain a complete parts manual, find your model and serial number. Then go to www.wisconsineng.com or call 920-459-8690 (USA) or ++420 508 313 301 (Europe.)

SPECIAL MESSAGES

Your manual contains special messages to bring your attention to potential safety concerns, potential causes of machine damage, and helpful operating and servicing information. Please read all the highlighted information carefully to avoid injury and damage to the machine.



WARNING: Engine exhaust, some of its constituents, and certain vehicle components contain or emit chemicals known to the State of California to cause cancer and birth defects or other reproductive harm.



WARNING: Battery posts, terminals and related accessories contain lead and lead compounds, chemicals known to the State of California to cause cancer and birth defects or other reproductive harm. Wash hands after handling.

WISCONSIN ENGINEERING CZ S.R.O.

Vrahovicka 41
796 01 Prostějov
Czech Republic
Tel: ++420 (0) 508 313 301
Fax: ++420 (0) 508 330 428
E-mail: info@wisconsineng.cz
Internet: www.wisconsineng.com

WARRANTY AND SERVICE INFORMATION

The information below is needed when contacting the dealer for spare parts and other technical service. Record Identification Numbers here.

If you need to contact an Authorized Service Center for information on servicing, always provide the product model and serial number.

You will need to locate the model and serial number for the machine and for the engine of your machine and record the information in the spaces provided below. Please complete and send in the registration card provided with your machine.

DEALER NAME:

DATE OF DELIVERY:

DEALER PHONE & ADDRESS:

PRODUCT IDENTIFICATION NUMBER:

Tel:

Fax:

Street:

ENGINE SERIAL NUMBER (B):

City, State:

Postal Code:

DATE OF PURCHASE:

Country:

Models covered in this manual:

MT8 110.25 M4

MT8 110.29 H4

MT8 110.26 M4

MT8 112.29 H4

MT8 110.26 H4

MT8 112.49 H4

MT8 110.28 H4

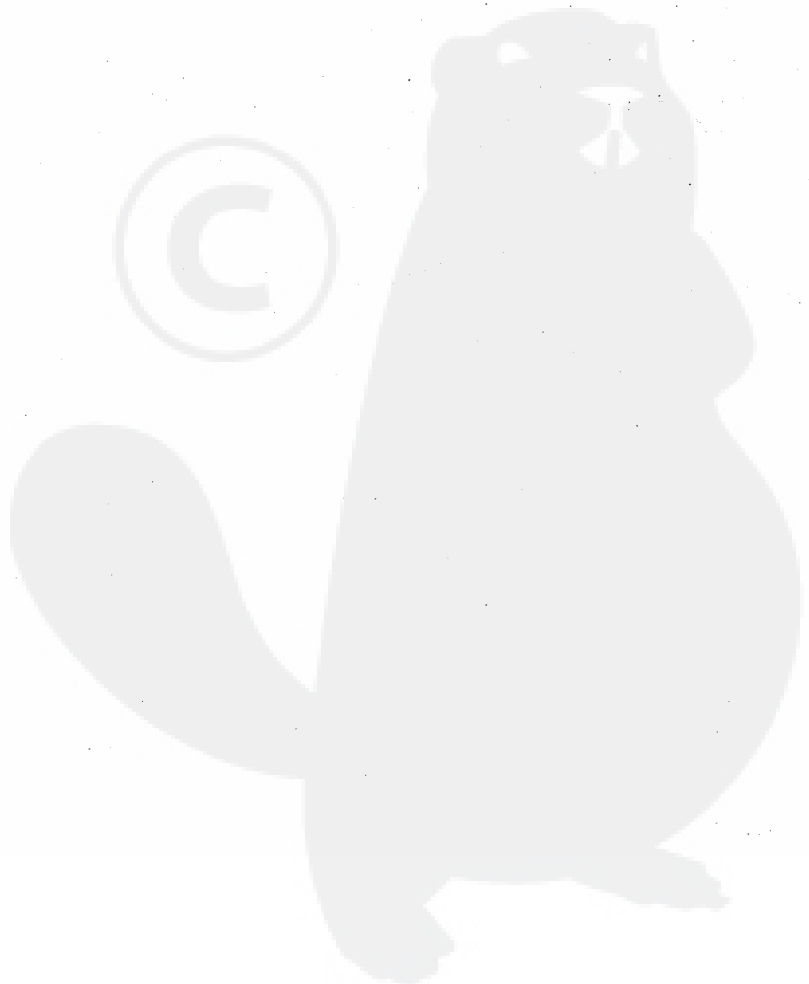
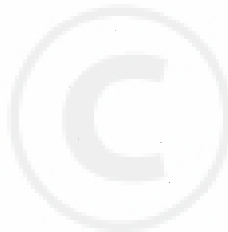

SAFETY

SIGNAL WORDS & SAFETY ALERTS



ATTENTION!
BECOME ALERT!
YOUR SAFETY IS INVOLVED!
OBEY THIS MESSAGE!

Attention!! The above SAFETY ALERT SYMBOL is used throughout this manual to bring attention to important safety instructions. For your safety and the safety of others, these instructions must be followed or **SERIOUS INJURY OR DEATH MAY RESULT.**

The signal words: **DANGER**, **WARNING**, and **CAUTION** are used with important safety messages in this manual. **DANGER** identifies the most serious hazards.

The machine safety labels shown in this section are placed in important areas on your machine to draw attention to potential safety hazards.

DANGER – IMMINENTLY HAZARDOUS SITUATION!!! WILL RESULT in severe personal injury or death if not avoided.



For functional purposes, some machine components cannot be guarded. The operator must exercise extreme care when dealing with these potential hazards.

WARNING – POTENTIALLY HAZARDOUS SITUATION! If not avoided, **COULD RESULT** in death or serious injury. **WARNING** is also used to warn you of unsafe practices.



CAUTION – POTENTIALLY HAZARDOUS SITUATION! If not avoided, **MAY RESULT** in minor or moderate injury. It may also be used to alert against unsafe practices.

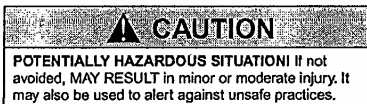

Pay close attention to sections of text marked with the above words. If any meanings are unclear, or if you have any questions, please contact Wisconsin Engineering or an authorized service center for clarification.

NOTATIONS

NOTE: General reference and helpful information for proper operation and maintenance practices.

IMPORTANT: Specific procedures or information required to prevent damage to the machine or an attachment.

EQUIPMENT SAFETY GUIDELINES

Safe operation is a major concern when operating any machine or piece of equipment. As many safety features as possible have been designed and built into your machine. This does not guarantee that accidents cannot happen.

Every year, many accidents happen which could have been avoided if a more careful approach to handling equipment was taken. Safe operation is the responsibility of the operator. You, the operator, can avoid such accidents by following the safe operation guidelines in this section and throughout the manual. For your safety, as well as those around you, study, understand, and follow the safety precautions in this section.



Remember - No one wants an accident. Safe operation begins with a safety minded operator. For your safety, as well as those around you, this machine must be operated in accordance with the safety precautions given in this manual.

Review safety precautions with all users at least once per year. All users should read carefully read through and understand the safety precautions presented in this text.

NEVER operate the machine beyond its ability, and never operate where you, the operator, feel it may be unsafe. Never exceed the limits of a piece of machinery. If the ability to do a job, or to do it safely, is in question – **DON'T TRY IT!!!**

NEVER allow children or persons unfamiliar with the equipment or this manual to operate this machinery. This is dangerous and can lead to an accident.

It is the responsibility of the customer to ensure this equipment will be operated in accordance with all local and state authorities. This equipment is not intended for use on public roads. When operating or transporting the mower, make sure all applicable local laws and regulations are followed.

Never operate a machine beyond its ability or for uses other than described in this manual.

Don't hurry in the learning process. Take your time and completely familiarize yourself with the controls and the contents of this manual before attempting to operate the machine.

SAFETY SHIELDS AND LABELS



The types of Safety signs and their locations on the equipment are shown on the next page. Safe operation requires that you become familiar with the signs, and the danger represented by each.

To provide a better view, some photographs and illustrations show the mower without certain safety shields. This is done for illustrative purposes only – the machine should never be operated in this condition. Keep all shields in place. If maintenance task require removal of a shield, replace all shields prior to use.

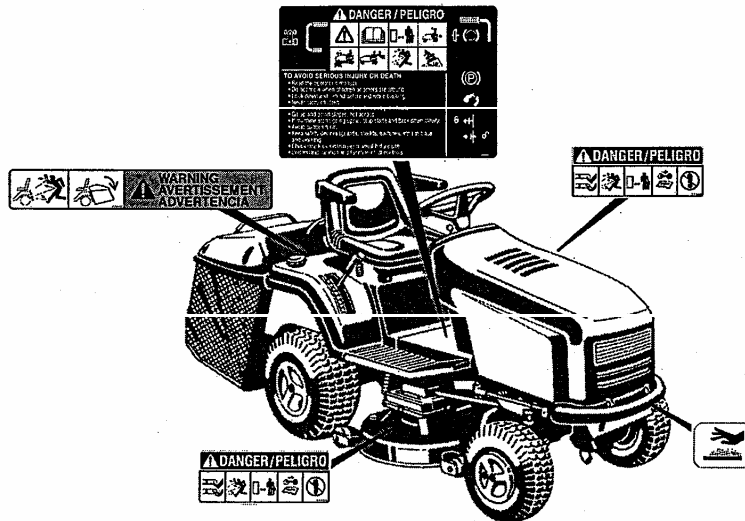

NEVER OPERATE THE EQUIPMENT IF:

- all safety shields and signs are not present
- all safety shields and signs are not correctly installed
- safety shields or signs are damaged or appear to be damaged

The safety decals provided on your equipment serve as visual deterrents to unsafe, dangerous practices. Never tamper with safety decals on the equipment. Replace any decals that are not readable or missing. Never paint over, remove, or deface any safety decals on this machine. Contact your dealer for replacement decals.

The machine safety labels shown in this section are placed in important areas on your machine to draw attention to potential safety hazards.

Safety Decals – Maintenance and Replacement

- Keep signs clean and legible
- Replace missing or illegible signs
- If replacing a part with a safety sign, make sure the replacement part also has the same sign

Contact your dealer or the manufacturer for replacement signs

ALWAYS replace missing, damaged, or unreadable Safety Decals. Refer to the figures in this section for safety decal locations.

REMEMBER: If Safety Signs have been damaged, removed, become illegible or parts replaced without decals, new decals must be applied. New decals are available from your authorized distributor or factory.

Safety Decals – Installing

1. Make sure the installation area is clean and dry
2. Decide on the exact position before removing the backing paper
3. Remove the smallest portion of the backing paper
4. Align the decal carefully and press the exposed adhesive into place
5. Slowly remove the remaining backing paper while smoothing over the decal and pressing it into place
6. Small air bubbles can be pierced with a pin and smoothed out using the backing paper

LEARN SAFE PRACTICES AND APPLICABLE LAWS

Practice usual and safe working precautions, for the benefit and safety of yourself and others. Understand and follow all safety messages, and always follow the practices set forth in this manual. Be alert to unsafe conditions and the possibility of minor, moderate, or serious injury or death. Learn the applicable rules and laws in your area.

OPERATOR TRAINING IS REQUIRED

The original purchaser of this unit was instructed by the seller on safe and proper operation by the seller.

The owner/user can prevent accidents with the proper use of this machine. The owner is responsible for training users of the machine.

If unit is to be used by someone other than original purchaser (if the machine is loaned, rented, or sold) ALWAYS provide this manual and any needed safety training before operation.

The owner/user is responsible for accidents or injuries occurring to themselves, other people, or property. Do not allow operation of the machine by untrained persons. *Accidents can be prevented if the machine is used properly.*

Read the operator manual and study the safety and operation sections before operating the machine. If the operator is unable to read or understand the material presented in this manual, it is the owner's responsibility to ensure this material is explained and understood by the operator. All users must learn the use of all controls. Practice is required to learn the machine's operating characteristics. Users unfamiliar to the machine should practice in a large, flat, open area under the supervision of an experienced adult operator.

ASSEMBLY SAFETY

Read, understand, and follow all safety practices in this manual before beginning assembly. Failure to follow instructions could result in personal injury and/or damage to unit.

ALWAYS remove key and wire from spark plug before assembly. Unintentional engine start up can cause death or serious injury.

OPERATIONAL SAFETY

Before operating the machine, complete an inspection of the machine, the work area, and the safety decals on the machine.

A careful operator is the best operator. Most accidents can be avoided by observing certain precautions. Read and take the following precautions before operating this tractor to help prevent accidents. Equipment should be operated by only those who are responsible and instructed to do so.

In addition to the design of the machine, hazard control and accident prevention are dependent upon the awareness, concern, prudence, and proper training of personnel involved in the operation, transport, maintenance, and storage of equipment.

The abbreviation "PTO" in the following text refers to the POWER TAKE OFF on your machine. It is the mechanism used to power to attachments such as the mowing deck. Engaging the PTO will engage the mowing blades of the mower deck.

WORK AREA



Clear mowing area of objects and debris that may be thrown by the mowing system. Thrown objects can cause injury.

Keep people and pets out of mowing area.

Plan your work. Study the mowing area and establish a safe approach. Plan ahead and avoid areas where traction or stability is questionable.

Avoid uneven work areas and rough terrain. DO NOT operate near drop offs, ditches, or embankments. Unit can suddenly turn over if a wheel falls over the edge of a cliff or ditch, or if an edge caves in.

Stay alert for hidden hazards. Tall grass, in particular, can hide hazards that may cause an accident.

Slow down when traveling over rough ground.

ALWAYS check overhead and side clearances carefully before operation.

ALWAYS be aware of traffic when operating along streets or curbs.

Check for weak spots on dock, ramps or floors.

Dust, fog, etc. can reduce vision and cause an accident. Operate unit only when there is good visibility and light.

DRUGS AND ALCOHOL

NEVER operate unit during or after the use of medication, drugs or alcohol. Safe operation requires your complete and unimpaired attention at all times.

CHILDREN AND ANIMALS



WARNING! AVOID INJURY. From their small size and often unpredictable behavior, children and animals present a unique safety hazard. Extreme caution should be exercised when they are in the mowing area or may be in the mowing area.

Keep children and people away. Be alert and shut off unit if children enter area.

Keep children out of work area and under watchful care of a responsible adult. Always be on the lookout for small children or their toys.

NEVER allow children to operate or play on or near the unit.

Always approach corners, shrubs, and other areas of compromised visibility carefully when operating around children.

When operating in reverse, be critically aware of blind spots.

NEVER allow children to operate the machine, ride on attachments, or carry them as passengers, even with the blades turned off. Do not carry or tow children in a cart or trailer.

PASSENGERS



NEVER carry passengers. There is no safe place on the machine for them.

Only allow the operator on the machine. Keep riders off.

Riders on the machine or attachment may be struck by foreign objects or thrown off the machine causing serious injury.

Riders obstruct the operator's view and limit ability to respond to an emergency, resulting in the machine being operated in an unsafe manner.

STARTING AND STOPPING SAFELY

Apply the parking brake, disengage the PTO, lower mowing deck or attachment to lowest position, and ensure transmission is in neutral before starting the tractor.

Do not start the engine or operate the controls while standing beside the tractor. Always sit in the operator seat when starting the engine or operating controls.

Do not bypass the neutral start or safety interlock switches. Consult your Wisconsin Engineering dealer if any safety devices malfunction.

Use jumper cables only in the recommended manner according to the cable manufacturer's instructions.

Avoid accidental contact with the gear shift levers while the engine is running. Unexpected tractor movement can result from such contact.

Do not get off the tractor while it is in motion.

Disengage PTO, shut off the engine, and apply the parking brake before getting off the tractor.

Do not park the tractor on a steep incline.

Do not operate the tractor engine in an enclosed building without adequate ventilation. Exhaust fumes can cause death.

PERSONAL SAFETY

Understand:

- How to operate all controls
- The functions of all controls
- How to STOP in an Emergency
- Braking and steering characteristics
- Turning radius and clearances

Familiarize yourself with all the controls so that you can stop quickly.

Read the manual carefully before operating the mower for the first time. Review manual at least once per year.

Allow only responsible adults who are familiar with this manual to operate the mower. Training includes actual operation.

Keep machines, safety devices, and safety signs in good condition.

Avoid sharp edges and rotating parts. Sharp edges and moving parts can cut off fingers, hands, toes, and feet.

ALWAYS keep hands away from all pinch points.

DO NOT touch machine parts which might be hot from operation. Allow parts to cool before attempting to maintain, adjust or service the unit.

NEVER place your hands or any part of your body or clothing inside or near any moving part while unit is running.

WEAR APPROPRIATE CLOTHING & SAFETY GEAR



Wear close fitting clothing and adequate safety gear for the job.

Wear proper footwear to improve footing on slippery surfaces.

DO NOT wear loose clothing or jewelry and tie back hair that may get caught in rotating parts.

Protect eyes, face and head from objects that may be thrown from unit. The use of safety goggles or safety glasses with side shields when operating the mower is strongly recommended.

Wear a suitable protective device such as earplugs. Loud noise can cause impairment or loss of hearing.

Do not wear radio or music headphones. Safe service and operation requires your full attention.

Protect hands from sharp edges by wearing protective gloves.

OPERATING SAFELY

The safety precautions listed here are to warn you about hazards while operating the lawn tractor. Carefully read the specific precautions given in the **SLOPE OPERATION** and **MOWING SAFELY** for *additional* precautions.

DO NOT operate unit if safety interlock system is damaged or disabled (See **CONTROLS** section).

DO NOT operate the mower without the entire collection/deflection system intact and functioning properly.

Turn the blades off when not mowing.

Familiarize yourself with the terrain you will cut and remove any toys, sticks, wires, and other debris which can be thrown by the mower. If some items cannot be removed, plan ahead to avoid them.

Make sure no other people, children, or animals are in the vicinity of operation. If someone approaches, disengage the blades and stop the machine.

Check control functions frequently.

Use extreme caution on gravel surfaces.

Stay alert for hidden hazards or traffic. Be prepared for different handling characteristics on different terrains and surfaces

Watch where you are going especially at row ends, on roads, around trees, and low hanging obstacles.

Watch for holes, ruts, or bumps. Uneven terrain could overturn the machine.

Always stand clear of the discharge area.

Always be aware of maximum sweep of collector when turning. Always allow adequate clearance between collector, personnel and other objects when turning.

Use extra care when towing a trailer or using any other attachments. These attachments may cause the machine to handle differently than when attachments are not used. Use only approved attachment points.

Limit loads to those within the machines capacity and that which you can safely handle.

Use counterweights or other devices as recommended by the attachments instructions.

Be very cautious and defensive when operating near traffic or roads.

DO NOT operate at too fast a rate. DO NOT change engine governor settings or over-speed engine.

Slow down before turning.

DO NOT operate near dropoffs, ditches or embankments. The tractor could suddenly turn over if a wheel is over the edge of a cliff or ditch, or if an edge caves in.

DO NOT try to stabilize the machine by putting your foot on the ground.

DO NOT operate in reverse unless absolutely necessary. ALWAYS disengage PTO and look down and behind before and while backing. If travel in reverse is absolutely necessary, than be absolutely certain of what is behind you and the mower.

ALWAYS disengage attachment, stop unit and engine, remove key and allow moving parts to stop before opening or removing the grass collector.

ALWAYS disengage attachment, stop unit and engine, remove key and allow moving parts to stop before leaving operator's position.

ALWAYS remove key to prevent unauthorized use.

Operate only in daylight or good artificial light.

Contact your dealer for any questions, uncertainties, or further instructions regarding safety

DO NOT leave the machine on and unattended. When dismantling the machine, always turn off the blades, engage the parking brake, turn off the engine, and remove the keys from the ignition.

DO NOT start or operate the machine indoors or where adequate ventilation is not available. Exhaust fumes contain carbon monoxide, an odorless and deadly gas. Always provide good ventilation.

DO NOT operate a machine in poor condition or if safety shields have been removed or damaged. ALWAYS keep protective structures, guards and panels in good repair, in place and securely fastened.

SLOPE OPERATION



Slopes and inclines present a major hazard to operating your mower safely. The machine will handle differently on slopes than when on level terrain. Slopes are a major factor contributing to loss-of-control and tip-over accidents. If you cannot operate safely or feel uneasy on inclined terrain, then do not mow it. Remember, a slope does not have to feel dangerous to be dangerous.

Do not drive machine where it could slip or tip.

Your machine is only rated for maximum slopes of 10%. Exceeding the operating capacity of the machine may cause it to tip and cause severe injury or death.

Use counterweights as recommended by the counterweight's manufacturer. These can provide added stability when operating on slopes or using rear mounted attachments.

Drive up and down slopes, not across them.

Always be slow, smooth, and deliberate when mowing across an incline - plan ahead to avoid sudden changes in speed and direction.

Remove any debris such as rocks and tree limbs which may cause loss of control.

Be aware of roots, rocks, holes, and stumps, which may be present on the hill. If these cannot be removed, plan ahead to avoid them. Remember, grass can hide these obstacles.

Be aware of changes in stability caused by attachments or as the grass container fills. If machine starts to tip or slip when going up a hill, disengage PTO and back slowly down the hill.

Avoid situations where the tires may lose traction - if the mower should start to slide, turn off the blades and proceed slowly DOWN the slope.

Be aware that wet grass can cause reduced traction and sliding.

Slow down before turning or operating on a slope. Choose an appropriate speed which can be maintained while on the hill. Changing speeds quickly on a hill can be dangerous. Turn in the downhill direction.

Limit loads to those you can safely control. Use only approved hitches when pulling loads or using heavy equipment.

DO NOT turn on a slope unless absolutely necessary.

DO NOT mow near ditches, ruts, drop-offs, or embankments as a tire may fall in or the edge of the terrain may collapse.

DO NOT try to stabilize the machine by putting your foot on the ground.

MOWER SAFETY



WARNING! AVOID INJURY.

Rotating blades can cut off arms and legs. Keep hands, feet and clothing away from mower deck when engine is running.

Be alert at all times, drive forward carefully. People, especially children can move quickly into the mowing area before you know it.

Before backing up, shut off PTO and look down and behind the machine carefully, especially for children. Do not mow in reverse.

Be aware of the direction of the mower discharge - never direct discharge towards persons or property that may be injured or damaged by thrown objects.

DO NOT run over any foreign objects which the blades may strike or pick up and throw.

Be very cautious when mowing near fixed objects. You should never deliberately run over any foreign object.

DO NOT mow on wet grass. Reduced traction could cause sliding.

As grass catcher fills, be alert to changing unit stability and control.

DO NOT mow near dropoffs, ditches or embankments. The tractor could suddenly turn over if a wheel is over the edge of a cliff or ditch, or if an edge caves in.

ALWAYS disengage attachment, stop unit and engine, remove key and allow moving parts to stop before opening or removing the grass collector.

Shut off blades when you are not mowing.

Park machine safely before inspecting or servicing mower or collector, or leaving the machine unattended.

Only mow during daylight or with good artificial light. Do not rely on the tractor's headlights (if so equipped) for adequate lighting.

ALWAYS slow down and be careful of traffic when operating near or crossing roadways.

Disengage PTO and wait for (attachment) movement to stop before crossing roads or sidewalks.

Stop PTO before operating near gravel roads.

Use care when approaching blind corners, shrubs, trees, or other objects that may obscure vision.

TRANSPORTING SAFELY

Use extra care when loading or unloading unit onto trailer or truck. Secure unit chassis to transport vehicle. **NEVER** secure from rods or linkages that could be damaged.

DO NOT transport machine while engine is running.

Secure attachments to prevent damage to unit.

Use extra care when loading or unloading the mower into or out of a truck or trailer. Follow all applicable laws and regulations. Always check overhead clearance when transporting the tractor.

PARKING SAFELY

Before you leave the operator's station, wait for engine and all moving parts to stop.

Park machine on a level surface only. Do not park on a slope.

Disengage PTO, lower attachment to ground, and remove key from ignition switch before leaving unit.

SERVICE AND MAINTENANCE

With regular service and maintenance, your machine is capable of providing years of safe and reliable service. A few simple checks and procedures before and after each use will promote safe operation.

Inspect your machine and your work area before you operate. The machine must be inspected before it is operated by you or anyone else. If the user is unfamiliar with the machine, then the owner is responsible for ensuring an inspection is performed by a qualified person familiar with this manual.

Be sure all hardware is correctly tightened

Repair or replace damaged, missing, or worn parts

Make sure all guards, shields, and signs are correctly installed and in good condition

Keep all parts in good condition and properly installed. Fix damage immediately. Replace worn or broken parts. Replace all worn or damaged safety and instruction decals.

ALWAYS make all necessary repairs, replacements, and adjustments before the machine is operated.

ALWAYS check the safety interlock system before each operation to make sure they are working correctly. Do not operate the machine if the safety interlock system is not working correctly.

DO NOT tamper with safety devices on the machine. They are there for your protection; if they are damaged or it is suspected they are not functioning correctly, then an authorized distributor should be contacted before the next use. Unauthorized modifications may impair its function and safety.

Stop engine before performing any service on the tractor. Disconnect battery or remove spark plug wire before making any repairs. If engine must be run, never run engine unless parking brake is engaged.

Lower attachments to the ground before servicing machine. Disengage all power and stop the engine. Lock park brake and remove the key. Let machine cool.

Keep the machine free of grass, leaves, spilled fuel, and excess grease to prolong service life and reduce the risk of fire.

Allow the machine to cool before storing.

Keep nuts and bolts, especially at blade attachment points, tight and in good condition.

Frequently check the condition of grass container components. They are naturally subject to wear; this wear may expose moving parts which may cause bodily injury or allow objects to be thrown. Frequently inspect these parts and replace them as needed with only factory certified replacement components.

Never use a bent or damaged mowing blade.

Use caution when handling blades, as they are sharp and can cut. Wrap the blade and wear gloves when servicing the blades.

Check blade attachment frequently. Adjust and service as needed.

Inspect the mower thoroughly after striking an object. Make sure the blades are not damaged. Trying to mow with bent or broken blades is very dangerous and can seriously damage the machine. Make repairs before you operate again.

Understand service procedure before doing work. Keep area clean and dry.

Never lubricate, service, or adjust machine while it is moving. Keep safety devices in place and in working condition. Keep hardware tight.

Keep hands, feet, clothing, jewelry, and long hair away from any moving parts, to prevent them from getting caught.

Securely support any machine elements that must be raised for service work. Support machine on jacks that are known to be strong and in good condition.

Tire Safety



CAUTION! AVOID INJURY.

Mounting and servicing tires requires special training and equipment. Incorrectly mounted tires can lead to bursting resulting in serious injury or death. Only trained and qualified personnel should service and mount tires.

Tires should only be replaced with tires of an equal or greater capacity rating than those specified by the manufacturer. Tires should always be kept inflated to the recommended pressure. Cracked, cut, worn, or otherwise damaged tires should be replaced prior to operating the mower. Allow only qualified personnel to install and service tires.

Tires can separate from wheel with explosive force. This can cause serious injury or death:

Only qualified personnel with training and experience should mount or demount tires from wheels. Do not attempt to mount a tire without the proper equipment and experience to perform the job safely.

Maintain the correct tire pressure. Do not inflate the tires beyond recommended pressure.

Do not heat or weld a wheel and tire assembly. The heat can cause an increase in air pressure resulting in a tire explosion. Welding can structurally weaken or deform the wheel.

When inflating tires, use appropriate equipment that allows you to be by the side of the tire and not in front of or over the inflating tire.

Check tires for low pressure, cuts, bubbles, damaged rims or missing lug bolts and nuts before each operation. Damaged tires should be repaired or replaced by qualified personnel only.

Fuel Hazards



WARNING! AVOID INJURY. Extreme care should be practiced when handling gasoline and other fuels; they are flammable and their vapors can be explosive.

- Transport fuel only in approved containers
- Allow the machine, especially the exhaust system, to cool before refueling
- Be cautious when removing fuel cap, especially in hot environments, as the vapor pressure may cause fuel to spray
- DO NOT** store fuel containers near heat sources or open flames
- DO NOT** smoke while handling fuels
- DO NOT** re-fuel the mower indoors or in areas where adequate ventilation is not available

Battery Maintenance



WARNING! AVOID INJURY. Use care when servicing the battery. Battery acid contact with skin may cause severe burns and acid contact with eyes may cause blindness.

- Exercise extreme care when handling the battery
- Always pay close attention to polarity when installing the battery
- Handle the battery according to the battery manufacturer's instructions
- Make sure all terminal shields are in place
- DO NOT** service the battery while smoking or near an open flame. Explosive fumes are produced inside the battery
- Charge batteries in an open, well-ventilated area, away from sparks. Unplug and make sure battery charger is off before connecting or disconnecting from the battery.
- Keep battery and cold weather starting aids away from open flame.
- Use jumper cables according to the jumper cable manufacturer's instructions.

PREVENT FIRES



- NO** smoking, **NO** sparks, **NO** flames. Turn engine off and allow engine to cool before servicing, removing fuel cap, or adding fuel.
- Fuel is highly flammable and its vapors are explosive. Handle with care. Use an approved fuel container.
- Do not remove fuel cap, or add fuel with engine running or hot.
- Never store equipment with fuel in the tank inside a building where fumes may reach an open flame or spark.
- Allow engine to cool before storing in any enclosure.
- To reduce fire hazard, keep engine free of grass, leaves, or excessive grease.
- Replace fuel cap securely after servicing and clean up spilled fuel immediately.
- Prevent fire and explosion caused by static electric discharge. Use only non-metal, portable fuel containers approved by the Underwriter's Laboratory (U.L.) or the American Society for Testing & Materials (ASTM). If using a funnel, make sure it is plastic and has no screen or filter.
- Never fill fuel tank or drain fuel from a machine in an enclosed area. Fill fuel tank outdoors.
- Remove equipment from trailer or truck bed before filling.

- Do not fill the fuel tank to capacity. Allow room for expansion.
- Do not drive equipment near open flames.

ACCESSORY AND ATTACHMENT SAFETY

- Use only properly installed attachments or accessories designed for the unit.
- Check attachment components frequently. If worn or damaged, replace with manufacturer's recommended parts.
- Grass catcher components are subject to wear, damage, and deterioration, which could expose moving parts or allow objects to be thrown. Frequently check components and replace with manufacturer's recommended parts, when necessary.
- Always lower cutting deck when unit is parked or stored.

WASTE PRODUCTS AND CHEMICALS



- Waste products, such as, used oil, fuel, coolant, brake fluid, and batteries, can harm the environment and people:
- Do not use food or beverage containers for waste chemicals.
- Contact your local recycling center to learn how to dispose of waste materials.
- Continuous long term contact with used engine oil may cause skin cancer. Avoid prolonged contact with used engine oil. Wash skin promptly with soap and water.
- The mower is only meant to be operated as outlined in this manual. Only qualified mechanics should be allowed to service the mower. Failure to use the mower as indicated voids warranties and can cause severe personal injury.
- All of the precautions presented here are for your protection as well as those around you. For your safety, as well as the safety of bystanders, you must read and understand all of the precautions presented here.

PREPARATION BEFORE OPERATION

Carefully study and understand this manual. Read through the whole manual before attempting to operate the equipment, paying special attention to the safety precautions presented in the text.

For transportation reasons, the mower is shipped partially disassembled.

Visually inspect the machine for damage, loose nuts or bolts, and take note of the safety signs and their messages. Make sure the tires are inflated to the specified pressure. Check all fluid levels and adjust if necessary. Before ANY operation, make sure the blades are securely fastened to the spindles and the bolts are tightened to the specified torque.

IMPORTANT: Remove tractor from pallet carefully to avoid damage to the tractor or mower.

PACKAGE CONTENTS:

- Tractor
- Steering wheel and installation hardware
- Seat and installation hardware
- Grass container and hardware
- Owner/Operator Manual
- 2 ignition keys
- Replacement fuses
- Replacement light bulb

SEAT

Install Seat

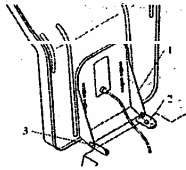

1. Align the holes in the fender brackets (2) with those on the tractor and secure with 4 bolts, nuts, and washers from the seat hardware bag.
2. Align the holes in seat bracket (1) with holes on fender brackets (2) and secure with a bolt, nut and washer (3). Do not over tighten these fasteners - the seat should pivot freely.
3. Attach the safety switch to the seat

Adjust Seat

The seat must be adjusted so that the operator can reach all controls quickly and efficiently. To adjust the seat:

1. Lift the seat
2. Slightly loosen the four screws holding the seat to seat bracket (1)
3. Adjust the seat position as needed.
4. Re-tighten hardware

INSTALL STEERING WHEEL

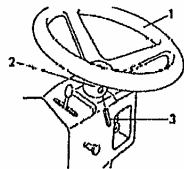

1. Line up the front wheels.
2. Lubricate column shaft
3. Put the steering wheel (1) on steering wheel shaft (2).
4. Align the hole on the steering wheel hub with the hole on the shaft. **MAKE SURE THE STEERING WHEEL IS CENTERED AND THE HOLES ARE ALIGNED.**

5. Drive the roll pin through the hole in the steering wheel shaft to secure. Ensure pin protrudes equally from both sides of steering wheel base.
6. **Hint:** Use a punch, awl, or screwdriver to drive the lock pin flush. This helps prevent marring the finish and damage to the pin.

FUELING AND ENGINE SERVICE

The lawn mower is shipped without oil and gas for safety. The crankcase must be filled with oil - the engine manual species the correct amount of oil to be used. The oil level should be checked with the transmission disengaged; this level should be between the MIN and MAX marks on the dipstick (See Figure 2.1.) Do not overfill the engine with oil or serious damage to the engine may result.

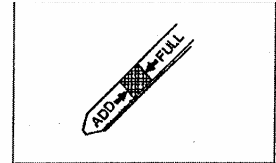
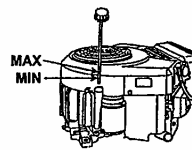

The fuel tank should be filled through a funnel from an approved container. Use unleaded gasoline only. The volume of the tank is approximately 9 liters (2.4 gallons.) Wipe away any spilled fuel immediately.

Before starting or operating the mower, read the engines manual for fuel, oil, and break-in specifications.



CAUTION! AVOID FIRE. WIPE AWAY ANY SPILT FUEL OR OIL IMMEDIATELY! Use extra care when handling fuels. They are extremely flammable, the vapors can be explosive, and they can burn skin and eyes. Allow the engine to cool before refueling. Never smoke while refueling.

The engine was "broken in" at the factory. No special break in procedure is required.

TIRE INFLATION

Proper tire inflation is important for an even cut and maintaining lawn mower balance. Check pressure using an automotive style tire gauge. Over inflated tires may burst. Never operate the mower with flat tire(s). Under inflated tires can fall off of the wheel during operation, leading to tire damage and dangerous loss of control. Always keep tires within the recommended pressure range. Recommended tire pressure is also printed on the side of the tire.

The front tires should be inflated to a pressure of 1.4 bars (20 psi) and the rear tires should be inflated to a pressure of 1.0 bars (15 psi) or as otherwise printed on the tire sidewall.



CAUTION! AVOID INJURY. Do not over inflate the tires or they may burst and cause serious physical injury.

BLADES

Before each operation, the blades should be checked to ensure all connections are tightened correctly and the blades are not bent or damaged. Damaged blades must be replaced.

Dull blades tear, rather than cut grass, and may turn the lawn yellow after cutting.

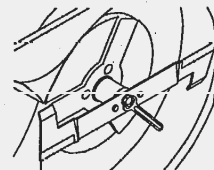



WARNING! Never attempt to inspect or adjust any part of the mowing system with the engine running. Always turn the machine off and wait for all moving parts to stop spinning before inspecting or accessing any part of the mowing system.

The outer bolts of each blade should be securely tightened, while the central bolt of each blade should be tightened to 45-50 Nm. The right blade has a left cut thread.

BELTS

The belts must be tensioned correctly to provide maximum performance and service life. The use of a belt tension gauge is recommended. One may be obtained through your dealer. See the Maintenance Section for the correct measurement point, tensions, and adjustment procedure.

ANTI-SCALPING CASTERS

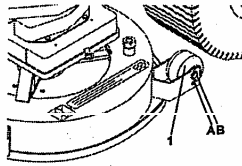

The mower deck anti-scalping casters (1) may be set to two positions (A or B). All four casters must be set to the same position. Do not adjust the casters to touch the ground while mowing, or uneven cutting may result. Never attempt to adjust the casters with the engine on or the blades spinning.

To adjust the casters:

1. Remove the retaining clip from caster pin (A or B), and remove the pin
2. Adjust the position of Caster Wheel (1)
3. Reinstall pin and retaining clip
- 4.



WARNING! AVOID INJURY! DO NOT ATTEMPT TO ADJUST THE CASTERS OR ANY PART OF THE EQUIPMENT WHILE THE BLADES ARE MOVING. Make sure the engine is off and the blades have stopped moving before attempting to adjust the mower deck wheels.

COLLECTION BIN



WARNING! AVOID INJURY. DO NOT OPERATE MOWER WITHOUT COLLECTOR OR APPROPRIATE ATTACHMENT CORRECTLY INSTALLED. The lawn tractor is equipped with a safety switch that will prevent the blades from engaging if the collector or attachment is not properly positioned in the fully down position. **DO NOT ATTEMPT TO BYPASS THIS SAFETY SWITCH.**

To assemble:

1. Unpack the grass container parts. Leave the protective foil on during assembly.
2. Attach the bottom support to the floor panel with nuts, bolts, and washers.
3. Attach the bottom support assembly to the supports with nuts, bolts, and washers.
4. Attach metal deflector plate to container cover.
5. Attach the supports to container cover with nuts, bolts, and washers.

6. Fasten the netting to the container. Spread the plastic clips on the support tubing.

Manual Lift Units

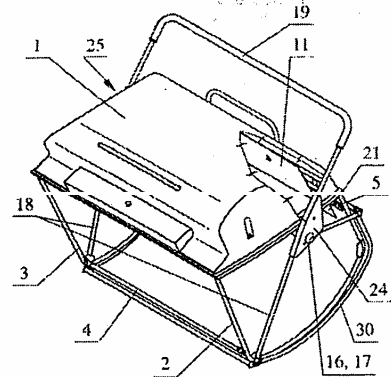

Power Bag Units

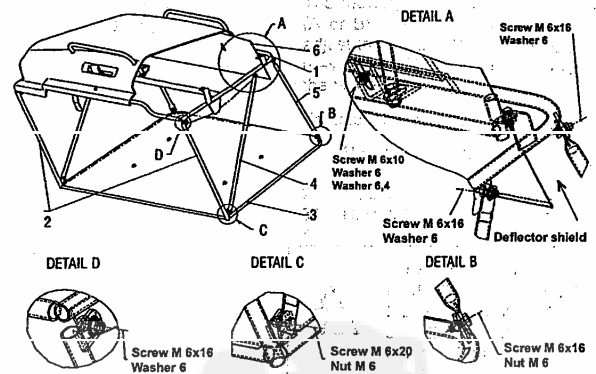

For units equipped with a power bag lift, the container lock lever must be in the locked position (1) for operation. To remove the collector from the machine, put the container lock lever to the unlocked position (2).

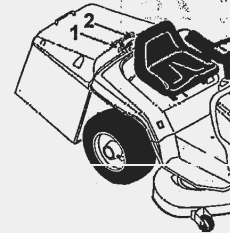

REMOVING PROTECTIVE FOIL

Your machine was shipped from the factory with a thin plastic foil covering plastic components. Remove this foil before operation if it has not already been removed.

CONTROLS

CONTROLS AND LAYOUT OVERVIEW

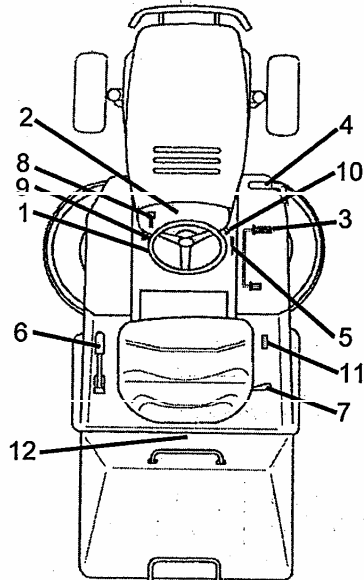

1. Steering Wheel
2. Dash Panel
3. Drive Pedal
4. Parking Brake Pedal
5. Parking Brake Engagement
6. Deck Height Adjustment
7. Transmission Push Valve Engagement*
8. Throttle
9. Choke (if available)
10. Ignition Switch
11. Collector Dump Switch
12. Grass Collector Lock Lever

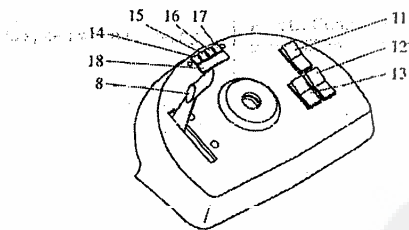

8. Throttle
11. PTO Switch
12. Automatic Mode Reset Switch (optional)
13. Automatic/Manual Mode Switch (optional)
14. Start Indicator Light
15. PTO Indicator Light
16. Parking brake indicator light
17. Full bag indicator light (optional)

18. Engine Hour Meter (optional)

DESCRIPTION OF CONTROLS

Drive Pedal

This lawn tractor is equipped with a hydrostatic transmission. This gives precise control over speed and greatly simplifies operation. One pedal controls both forward and reverse travel of the tractor.

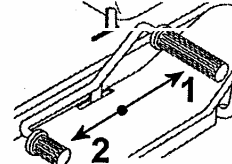

Press the larger end of the pedal (1, toe-end) to drive the tractor forward. Press the smaller (2, heel-end) portion of the pedal downward to drive the tractor backward.

Let the pedal return to neutral to stop the mower. The mower can slow down very quickly so plan ahead and allow adequate room for a smooth, controlled stop.



CAUTION! Speed is proportional to the amount by which the pedal is depressed. Engage the drive slowly to prevent lurching and "wheelies" which may result in loss of control or damage to the machine.

The tractor will stop quickly when foot is taken off drive pedal. Remove foot slowly for a smooth stop.

Transmission Bypass Valve



The hydrostatic transmission is equipped with a bypass valve which allows free movement of the rear wheels when the engine is off.

IMPORTANT: This valve must be opened when the machine is being pushed or damage to the machine may result.

The bypass lever is found beneath the operator's seat. Turn the lever forward to engage transmission. Turn lever backward to allow free movement of the rear wheels.

Brake Pedal

Fully depress brake pedal to apply brake.

IMPORTANT: DO NOT rest foot on brake pedal during operation as belt damage will occur.

Brake pedal must be depressed fully for starting.

Parking Brake



The parking brake must be engaged whenever the machine is left unattended.

To engage the parking brake:

1. Depress and hold the brake pedal fully (to position 2)

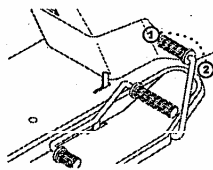

2. Move and hold the parking brake lever towards position 2 and release the parking brake pedal gradually.

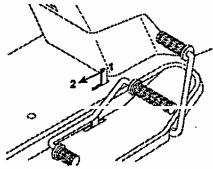

To disengage the parking brake, depress the brake pedal fully. The engagement lever springs back automatically. A mechanical click will be heard.

Deck Height Adjustment

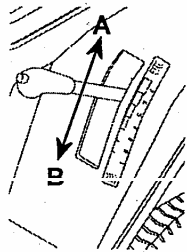

Raise the deck by pulling the lever towards position A to the desired deck height.

Lower the deck by depressing the button on the end of the lever and moving lever towards position B to the desired deck height.

The calibrations on the decals are for reference only and do not signify specific operating heights.

Throttle

The throttle changes engine speed. Depending on engine model, this lever may also control the engine choke.

Move lever to fast (1) position to increase engine speed. Move lever to slow (2) position to decrease engine speed.

IMPORTANT: Set throttle to approximately 1/3 speed when engaging PTO.

Choke



Engages the engines choke. Engage the choke to start a cold engine. See OPERATING section. On some models, the choke and throttle levers may be combined. If choke and throttle are controlled through a single lever, CHOKE position is beyond MAX throttle position.

NOTE: A warm engine should not be run with the choke engaged. After starting and allowing the engine to run for a few moments, disengage the choke slowly. If the engine speed changes, reengage the choke until the engine will run smoothly after the choke has been returned to the off (open) position.

Ignition Switch

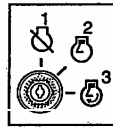

The ignition switch is operated by a removable key. To start the unit, insert the key. Turn the switch clockwise from the off (1) position to the start (3) position. The key will spring back to the run (2) position.

The key can only be removed from the ignition when in the OFF position. Attempting to remove the key in a position other than OFF may damage the ignition switch.

PTO Switch

To turn the PTO on (to engage the mowing blades), push this switch to the ON position. To disengage the PTO (disengage the mowing blades), push the switch to the OFF position.

Automatic Mode Reset Switch



In auto mode, this button is used to reset the full-bag detection system after a full bag has been detected (and emptied.) This button has no function in manual mode.

Automatic/Manual Mode Control Switch

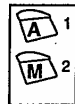

When in the AUTO position, automatic control of the grass collector filling is activated; when in the MAN position, blade engagement is entirely controlled by the Blade Engagement Switch.

Collector Dump Switch



To open grass container, press lift switch to raise position (1). To close grass container, press lift switch to lower position (2).

IMPORTANT: Release lift switch immediately when clicking sound is heard. Clicking sound indicates container cannot travel further.

CONTAINER LOCK LEVER

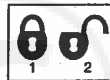

Place container lock lever in LOCK position (1) to lock container onto tractor. Place container lock lever in UNLOCKED (2) position to allow container removal.

NOTE: Container lock lever must be in LOCKED position when using power lift to empty grass container.

INDICATOR LIGHTS

Ignition Indicator

Indicates ignition is in the RUN position

Blade Engagement Indicator

illumination indicates blades are engaged

Parking Brake Indicator

illumination indicates the parking brake is engaged

Full Bag Indicator

illumination indicates full collection system is full, stays on until system is reset

Engine Hour Meter

Optional indicates total operating time of engine

(indicators may be optional equipment)

FULL BAG SHUTOFF SYSTEM

Overview

Wisconsin Engineering's patented **FULL BAG SHUTOFF (FBS) SYSTEM** virtually eliminates clogging, and is perhaps the most advanced system of its type available. By precisely monitoring flow through the discharge chute, the Wisconsin Engineering FBS system is not adversely affected by grass or terrain conditions.

Grass containers can fill quickly, especially when mowing tall grass or vacuuming large amounts of leaves and other debris. Often, the container may fill sooner than anticipated by the operator. This typically leads to clogging of the mowing system, which is not only a time-consuming inconvenience, but can lead damage equipment.

The system has two settings:

- (1) Automatic mode
- (2) Manual mode

Automatic Mode: In automatic mode, the FBS system automatically disengages the blades and illuminates the dash control when the collector has been filled to approximately 90% of capacity. After the blades have been turned off, either the PTO engagement or Reset button is used to resume mowing.

Manual Mode: The manual mode overrides the FBS system, and mowing is controlled through the PTO on/off switch only. It is recommended to use the automatic mode at all times to prevent clogging.

Mowing in the manual allows the operator to:

- (1) finish up a cut before dumping
- (2) bypass the FBS system in extreme conditions

With the **AUTO/MAN SWITCH** in the **MANUAL** position, blade engagement is entirely controlled by the operator via the **BLADE ENGAGEMENT SWITCH**. When mowing in this mode, the operator should check the fullness of the collection container frequently, as overfilling may result.

Using the Full Bag Detection System

With the **AUTO/MAN** in the **AUTO** position, the full-bag detection system is activated. Once mowing is begun, the blades will be engaged until either:

- (1) the operator disengages them using the **PTO ENGAGEMENT SWITCH**, or
- (2) the container is full.

The manual and automatic modes of operation are identical until a full bag is detected - the operator maintains full control of blade engagement via the **PTO ENGAGEMENT SWITCH**. You can start and stop the blades as needed using this switch.

Once the collector is full, the blades are automatically disengaged and the full container indicator light turns on. Raise the deck and transport

the mower to the disposal area. Empty the container and transport the mower back to the work area. Adjust deck position, and prepare for mowing. Once ready to resume mowing, depress the reset switch and the blades will engage. If you are done mowing, turn the blade engagement switch off, depress the reset switch, and clean and store the mower.

You may find it necessary to press the **RESET** when beginning a new mowing session if the system was not **RESET** after the last full bag. A full bag may be remembered even if the engine is turned off.

NOTE: When detection system stops mower, the grass container must be emptied and reset switch must be depressed before mowing can continue.

NOTE: When full-bag detection system is activated, operator must empty full grass container before PTO can be engaged.

If the FBS system activates near the end of the row, switch to manual mode to use the reserved capacity in the collector.

IMPORTANT: BE AWARE THAT CLOGGING WILL RESULT IF THE COLLECTOR IS OVERFILLED.

SAFETY INTERLOCK SYSTEM (SIS)



WARNING! Never tamper with the safety interlock system. It is designed to protect you and those around you from an accident. Tampering with safety components may render your machine unsuitable for safe operation, and will void warranty.

The mower is equipped with a safety interlock system (SIS). This system is for your protection - never tamper with the safety systems found on the machine. Do not attempt to disconnect, bypass, or "fix" the switches into any position - doing so is dangerous and invites an accident.

SIS will prevent engine starting if brake is not engaged or if the PTO is engaged. It is necessary to push the parking brake pedal down fully to start the machine. PTO must be disengaged to start.

The SIS will turn engine off if seat is not occupied while blades are engaged or operator leaves seat without engaging parking brake.

You must sit fully in the seat; the seat may need to be adjusted so that adequate weight is on the seat. If you experience erratic engine operation while transporting or mowing, you may need to adjust the seat so that adequate pressure is placed on the seat even in bumpy terrain.

The PTO will not engage if the grass container or appropriate attachment is not properly installed and in operating position.

OPERATING

FILLING FUEL TANK

To add fuel to Fuel Tank:

1. ALWAYS place unit in open or well ventilated area.
2. Stop engine and allow to cool.
3. Clean fuel cap and surrounding area to prevent dirt from entering fuel tank.
4. Remove cap.

IMPORTANT: See engine manual for correct type and grade of fuel.

5. Fill fuel tank 1/2" (11mm) below fill neck. Tank capacity is 9 liters (2.38 Gal.).
6. Replace fuel cap and tighten.
7. ALWAYS clean up any spilled fuel.



WARNING: Avoid Injury! Read and understand *Fuel Safety Rules* in *Safety* section before proceeding.

PRESTART

Before starting:

1. Check engine oil and fill if necessary. See engine manual.
2. Check and fill fuel tank if necessary.
3. Check safety interlock system.

STARTING THE ENGINE



WARNING! Never start or run the engine indoors or in poorly ventilated areas. Engines exhaust fumes contain carbon monoxide, an odorless and poisonous gas.

To start the engine:

1. Sit in the operator's seat.
2. Disengage the PTO.
3. Apply choke for a cold engine, place at 1/3 throttle for a warm engine.
4. Fully depress brake pedal.
5. Turn the ignition key clockwise to the start position until engine starts.
6. Release key into run position.
7. After engine starts, set throttle to fast position.
8. Allow engine to warm up before applying load.

The mower is equipped with a safety switch which turns the engine off the seat is unoccupied. The mower cannot be started unless you are sitting in the seat or have the parking brake engaged, and the PTO is off.

IMPORTANT: Run engine at 1/2 throttle for at least five minutes prior to applying load in below freezing temperatures.

IMPORTANT: Do not attempt to start the engine for more than 15 seconds per minute. Continuous cranking can cause the starter to overheat. Allow the starter to cool for 2 minutes after cranking for 15 seconds. If the engine fails to start, consult the engines manual.

NOTE: It is good practice to adjust the engine throttle to "idle" before turning the engine off; doing so will reduce muffler pop and facilitates the next starting.

DRIVING THE TRACTOR TO AND FROM THE WORK AREA

The motion of the mower is controlled by the drive foot pedals. The drive pedal controls both forward and reverse driving.

The parking brake pedal is generally not used while driving the mower; allowing the drive pedal to return to neutral should provide adequate braking. The machine can slow down quickly; plan stops and operate the mower in a smooth, controlled fashion.

Before transporting the tractor, make sure the parking brake is disengaged. When transporting the mower to and from the work area, make sure the mowing deck is in the highest position. If not, blade and deck damage may result.



CAUTION! Avoid Injury! Come to a full stop before changing forward/reverse direction. Machine damage or loss of control may result if the transmission is operated against the direction of motion.

The mower will act differently on paved surfaces and off-road. Anticipate and be prepared for this change!!

This machine is not intended for use on public roads; do not operate on public highways. When mowing near roads, be on the lookout for traffic and also pay close attention to the direction of discharge.

MOWING

DANGER! AVOID INJURY. The mowing system can easily sever fingers, hands, and feet. Never bring hands or feet close to the mowing system with the engine running.

Always keep feet on the floorboards and away from the mowing system.

Never attempt to adjust any part of the machine with the engine running.

Clear the mowing area from foreign materials, such as stones and branches, which may be picked up and thrown by the mowing system.

Scan the area for obstacles which may cause loss of control or damage to the mowing system. Wear appropriate dress and safety equipment and make sure all of the safety precautions listed in Section 1 are observed.

Using FBS System

NOTE: Refer to CONTROLS section for detailed instructions on how to operate the Automatic full bag detection feature.

1. Start the engine and transport the tractor to the mowing area. Lift deck to highest position to prevent damage to mowing system.
2. Adjust the deck height to the desired level and make sure the grass container is correctly installed and in the fully down position.
3. Engage automatic or manual mode and set throttle to about 1/2 speed.
4. Engage the PTO. If mowing in Automatic mode, it may be necessary to depress the Reset button in order to engage the blades. Move throttle to full speed.
5. Use the drive pedal to move and the steering wheel to change direction.
6. To stop mower, disengage PTO.

NOTE: Select a travel speed appropriate to the mowing conditions; use slower speeds for tall or wet grass and faster speeds as appropriate. The engine should not change speeds. If the engine begins to "bog down" and stall while mowing, then speed needs to be reduced or the cutting height needs to be increased.

Observe all safety precautions stated in the SAFETY section.

SLOPE OPERATION

Always follow the safety precautions listed in the Slope Operation of the SAFETY SECTION. Remember, mowing on slopes requires extra care. The machine will handle differently than when on level terrain.

Always mow slopes only up and down grades (in the up and down direction), never across. Avoid sudden changes in direction and be alert to obstacles in the mowing path.

Make sure the parking brake is engaged and the key is removed from the ignition if the mower must be left unattended on a slope.



WARNING! Avoid Injury! Do not mow slopes greater than 10%. The mower may tip resulting in severe injury or death. Never operate the machine on terrain you are not sure you or the machine can safely handle.

Always be prepared for the change in handling as container fills.

The danger of slopes cannot be understated. There is very little the operator can do once handling is lost on a slope. Rollovers and slope related accidents lead to many needless injuries and deaths every year – all of these accidents could have been avoided if the operator would have used more discretion and common sense. *Don't mow a hill if it is steeper than either you or your machine can safely handle!!*

Operators unfamiliar with the handling of the mower should never attempt to mow a slope until they are familiar with the machine, how it behaves, and how it may respond.

When mowing unfamiliar terrain, start at the bottom of the slope.

GRASS CONTAINER OPERATION

Check the fullness of the grass container frequently while mowing if not cutting in the automatic mode. Make sure the container does not become overfilled during operation, or the discharge chute may clog. It is much easier to empty the container more frequently than to unclog the discharge chute.

Manual Units

1. Drive the mower to the area in which the grass will be dumped.
2. Disengage the PTO. Remember to be alert to what is behind the mower when operating in reverse.
3. Reduce engine speed to idle and engage the parking brake.
4. Turn engine off.
5. Grab the collector lift bar and pull towards seat.
6. Lower the container to down position. It may be necessary to remove any large heaps of grass from beneath the container, or to drive forward a short distance.

PowerBag Units

To empty container:

1. Drive the mower to the area in which the grass will be dumped.
2. Disengage PTO, reduce throttle to slowest position, and engage the parking brake.
3. Shut engine off and place key in run position.
4. Raise grass container using lift switch. When you hear clicking sound, grass container is lifted to maximum height.

IMPORTANT: Release lift switch immediately when change in motor pitch is heard.

5. Remove any large heaps of grass under the container that may prevent it from mounting back on the unit, or drive forward a few feet.
6. Lower grass container completely using lift switch.

To empty container manually:

NOTE: The container must be in the locked position.

1. Drive the mower to the area in which the grass will be dumped.
2. Disengage PTO, reduce throttle to slowest position, and engage the parking brake.
3. Shut off engine and remove key.
4. Lift the large lift bar on grass container and empty.
5. Remove any large heaps of grass under the container that may prevent it from mounting back on the unit.
6. Place the grass container back in operating position.

When mowing in Auto mode, it is necessary to press the RESET BUTTON to re-engage the blades.

Installing and Removing Grass Container

NOTE: It is much easier for two people to install or remove grass container.

To install:

1. *PowerBag units only:* Move the container lock lever to the unlocked position.
2. Lift the container using small handle (Figure 8) so the front of the container can clear the support brackets on the back of the tractor.
3. Angle the container so the front is slightly lower than rear and align it with sides of tractor fender.
4. Lower the container slightly until the container rests firmly on the support brackets on the rear of the tractor.
5. Move the container lock lever into the lock position.

Simplified PowerBag Collector Installation

NOTE: This feature is not available on manual collectors.

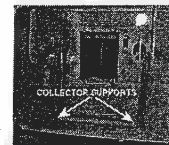
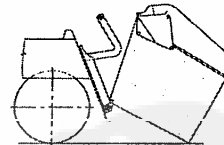

1. Rest the lower edge of the collector on the supports shown above.
2. Make sure the collector is in the middle (centered side-to-side) of the panel.
3. Rotate top of collector forward over hooks.
4. Free the lower edge of collector from supports – bag should slide onto hooks. Do this by lifting the back of the collector forwards + upwards by the grab bar.
5. Check installation – bag should move freely.
6. Lock bag.

MOVING THE UNIT MANUALLY

IMPORTANT: DO NOT push or pull (tow) tractor with another vehicle. Transmission damage will occur.

1. Engage the parking brake and stop engine.
2. Disengage transmission using bypass lever.
3. Release parking brake.
4. Push unit to desired location.
5. Apply parking brake and engage transmission.

SHUT OFF

Emergency Shut-Off

To shut-off unit in an emergency, turn ignition key to the off position.

Normal Shut-Off

1. Remove foot from forward or reverse pedal.
2. Disengage PTO.
3. Lower attachment and engage parking brake.
4. Move throttle lever to slow position. Let engine run a few minutes so engine parts cool evenly before shutting engine off.
5. Turn ignition key to the OFF position and remove key.

PARKING

To engage parking brake:

1. Stop machine on a level surface. Do not park on a slope.
2. Disengage PTO.
3. Lower attachments to the ground.
4. Lock park brake.
5. Stop engine.
6. Remove key from ignition switch.
7. Before you leave the operator's station, wait for engine and all moving parts to stop.

MOWING HINTS

Mow in longitudinal and cross directions and slightly overlapping previous cuts. This gives a better quality cut and better final appearance.

When mowing tall grass or vacuuming debris, slower speeds generally provide better results.

Keep the mower blades sharp and the mowing system in good shape. Dull blades tear grass and leave a white cast over a freshly cut lawn.

When mowing very tall grass, it is recommended to mow twice. Mow very tall grass with the deck in the highest operating position, and mow a second time to cut the grass to the desired height.

Cut grass when it is dry. Wet grass may stick inside mower pan and not discharge, mulch or bag properly.

Mower deck should be properly leveled for best mowing performance.

Mow with engine set at full throttle to maintain proper blade speed and air flow.

IMPORTANT: Frequently check grass collection components for damage. Ensure moving parts are not exposed. Replace damaged parts with manufacturer's recommended parts.

ATTACHMENTS

When using attachments, always refer to the attachments instructions for correct operation and installation.

Dispersing Hood: Excellent for mowing large areas where it is preferred not to collect the clippings. For such situations, the dispersing hood is used instead of the collection bin. The hood spreads clippings onto a wide area behind the machine to prevent windrowing.

Mulching Kit: The mulching kit consists of an additional set of mulching blades and a shield to block the discharge chute. Grass is cut into many fine pieces before being deposited to the lawn; this returns nutrients to the soil and promotes a healthy lawn.

Always refer to the attachment's manual for operating instructions.



CLEANING AND STORING

Properly clean the mower after each operation. A few extra minutes spent cleaning and maintaining your mower at the end of each session will ensure your machine will continue to look good and function well.

Grass, leaves, and other debris allowed to collect on the unit not only look bad and are harder to clean later, but can reduce performance, decrease belt life, and promote rust.



WARNING! AVOID INJURY! Be certain the engine is off and the blades have stopped rotating before attempting to clean the mowing system.



WARNING! AVOID INJURY. Before cleaning, washing, or storing the mower, turn the engine and blades off, and remove the key from the ignition, and wait for the blades to stop spinning before attempting to clean the unit. Make sure the engine, especially the engine exhaust, has cooled before attempting to service or clean the unit.

CLEANING

After each mowing:

1. Remove dirt and large clumps of debris from the surface of the mower, discharge chute, grass collector, and mowing deck.
2. Remove any grass or clippings from the inside of the container as well but only after the engine is off and the blades have stopped spinning.
3. Remove large clumps of grass and clippings by hand.
4. Use a water spray to wash what is left behind – see next section.

Do not allow grass to decay in the collector – decaying grass will reduce service life of netting.

Cleaning the grass from the machine is easier while the clippings are still fresh, and will greatly reduce the likelihood of staining.

WASHING

IMPORTANT: NEVER spray water directly at engine or electrical components. Cover muffler openings after cooled to prevent water getting into muffler.

To wash the unit, proceed with the following:

1. Put the tractor on a level surface free of debris

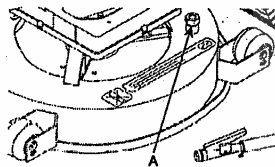

2. Wash the inside of the mower deck and the discharge chute. This can be done by attaching a garden hose to the hose fittings (A) on the deck, and turning the water, engine and blades on. Before cleaning,



WARNING! AVOID INJURY. Make sure the hose cannot contact or be picked up by the mowing system.

3. Clean until water is clear and turn off PTO, engine, water, and disconnect the hose. Lift the collection container, and wash the discharge chute and the inside of the collection container.
4. Wash surface of tractor with low (hose) water pressure and a mild detergent.
5. Use only mild detergents when washing the mower.

6. Remove the grass collector from the mower and wash it thoroughly.
7. After washing the mower, remove any muffler covering, and run the engine for several minutes to clear the system of any water. Engage the blades briefly to remove standing water in the mowing system.
8. Dry the mower with a soft cloth.

STORING



WARNING! AVOID FIRE! Allow engine and exhaust components to cool completely before covering.

Clean, wash, and dry the tractor. The lawn mower should be stored in a dry place, protected from bad weather and moisture. It is recommended to cover the mower. Do not cover the mower immediately after operation; allow engine and exhaust to cool before storage to reduce the risk of fire and to allow the mower to properly dry.

If storing unit outdoors and covered, make sure the tarp or covering cannot "flap" in the wind. This can allow water to reach the mower, and can also chafe the surfaces.

Keeping the machine dry is the best way to prevent rust and surface deterioration.

EXTENDED/SEASONAL STORAGE

If the mower will not to be used for a period of greater than one month, several steps must be taken in addition to those mentioned in the previous sections. A few hours invested in taking care of the mower before storage are well worth the effort when the mower is clean, rust free, and easy to start at the beginning of the next season.

Drain fuel tank completely. Gasoline will form gummy deposits if permitted to stand unused for an extended period. These deposits can damage the fuel system.

Lubricate all points shown in the lubrication chart. Use high-quality automotive or marine grade grease or water-displacing spray lubricant. Repair chipped paint before storage.

Replenish grease and spray linkages/cables at least once a month during storage, more frequently if the unit is stored outdoors.

Charge battery per battery chargers instructions. Disconnect and remove the battery. Store in a cool, dry place. Check battery voltage periodically, and charge if needed. Allowing batteries allowed to remain undercharged/uncharged for prolonged periods will ruin them.

Consult the engines manual for additional engine storage instructions.

Always remove the ignition key when you leave the tractor.

MAINTENANCE, SERVICE, AND ADJUSTMENTS

This manual contains information regarding safe handling and proper maintenance procedures. For information not contained within this manual, it is necessary to contact an authorized dealer or service center.



WARNING: AVOID INJURY. Read and understand *Maintenance and Service* and *Battery Safety Rules* in *Safety* section before attempting any maintenance.

UNIT IDENTIFICATION & TECHNICAL SERVICE

Each lawn mower is delivered with a manufacturer's label which indicates model, serial number, and year of production. These numbers are necessary when ordering parts or contacting an authorized dealer for service or parts. For safety and to ensure high quality, only OEM or factory certified spare parts should be used on your mower.

Warranty is provided as stated in the warranty literature provided with your unit. Both engine and battery are covered by the warranty provided by their respective manufacturer.

SERVICE POSITION

Place unit on a flat level surface. ALWAYS stop engine and disengage PTO. Assure unit is secure and will not tip over. Strap and clamp onto lift if used. Open hood to access battery or engine.

CHECK SAFETY INTERLOCK SYSTEM

Check safety interlock system before every use.

DO NOT operate unit unless safety interlock system is functioning properly. If it is not functioning properly, contact your equipment dealer or Wisconsin Engineering

Engine must shut off if operator leaves seat with:

- Transmission engaged or
- Parking brake is disengaged or
- PTO engaged.

Engine must not start unless:

- parking brake is engaged (or brake pedal is depressed)
- PTO is disengaged

Engine must turn off if collector is opened while PTO is engaged.

The mower will not engage if the grass container is not properly installed and in closed position.

CHECK FASTENERS

Be certain that all hardware is tightened to the proper torque. Pay special attention to the blades, guards and safety shields.

ENGINE SERVICE

The engine used in your mower are very sophisticated and reliable, however, they still require periodic maintenance to keep them running optimally. A routine maintenance schedule will ensure a long, productive service life.

The engine should be serviced as recommended in the engines manual. In the event that the recommendations here disagree with those provided by the engine manufacturer, always follow the engine manufacturers guidelines.

Engine Oil Change

The engine oil should be changed as recommended in the engines manual. Change engine oil after the first 5 hours of operation, and

every 25 hours after that, unless otherwise stated by the engine manufacturer.

Only change the oil when the engine is cool. The engine oil heats up quickly and gets very hot. Hot oil can cause serious burns.

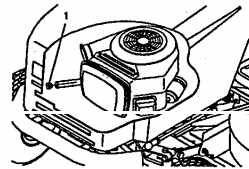

Your tractor is equipped with an oil change plug; To change the engine oil:

1. Place a flat bottom container with a capacity greater than engine oil capacity beneath the engine and mower.
2. Remove the oil filler cover to serve as a vent for air.
3. Position oil disposal container so that oil will drain into it. (Use of a funnel is recommended.)
4. Remove the drain plug.
5. Allow the oil to drain completely.
6. Reinstall the drain plug when all oil is drained.
7. Reinstall oil filler cap.
8. Add new oil as stated in engines manual.
9. Dispose of the used oil in an environmentally responsible manner

Note: slightly warm oil flows easier. PTO. Assure unit is secure and will not tip over.

Oil Filter, Air Filters, and Other Engine Service

Follow the engines manual for recommended maintenance procedures. Keep the engine clean and free of grass, leaves, and other debris. Keep linkages clean and free of dirt.

Filters should be changed at least seasonally under normal operating conditions and usage rates. Extreme conditions such as very dusty environments and heavy usage will require more frequent service. Refer to the maintenance chart given at the end of this chapter.

POWER BAG LIFT

The lifting arm of the actuator must be kept clean. The power bag lift motor and actuator are sealed and self-contained, and require no additional maintenance. Contact your dealer if you suspect problems with the power bag lift.

BULB REPLACEMENT

Do not apply excessive pressure to bulbs as they may break and cause injury!

Replace defective bulbs only with equally rated bulbs (5 Watts @ 12 Volts) bayonet-type base bulbs.

To remove a bulb:

1. Gently push the bulb towards the base
2. Twist until the bulb is free.

Repeat above procedure to install bulb.

FUSE REPLACEMENT

Make sure to identify and correct the problem that resulted in a blown fuse before replacement.

The fuse box is located on the engine solenoid. To replace a blown fuse:

1. Lift the hood

2. Locate the fuse box
3. Remove the blown fuse
4. Replace with equally rated fuse

Engine/Starting System: 10 Amp Fuse
 Power Bag Lift System: 40 Amp Fuse

If malfunctioning exists after the fuse has been replaced, contact an authorized service dealer.

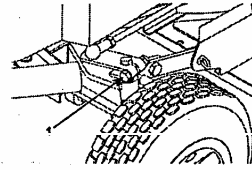

BATTERY



WARNING: AVOID INJURY. Read and understand *Battery Safety Rules* in *Safety* section before attempting any battery maintenance.

Clean Battery

1. Keep battery and its terminals clean. Inspect every 25 operating hours or monthly for best performance.
2. Disconnect cables from battery (negative, then positive).
3. Clean terminals and battery cable ends with wire brush until bright.
4. Coat terminals with grease or petroleum jelly to reduce corrosion.
5. Reconnect cables to battery (positive, then negative).

Electrolyte Level

The following is not applicable to maintenance free batteries.

Every 25 hours of operation or each week check electrolyte level of each cell. The electrolyte level should be at level indicator. Use distilled water to fill each cell if needed.

STEERING

The clearance / freeplay in the steering system may need to be adjusted after the first 5 hours of operation. This is normal and does not indicate a problem with the machine.

The procedure may be repeated periodically to adjust freeplay in the steering system.

Adjusting Freeplay

To adjust steering freeplay:

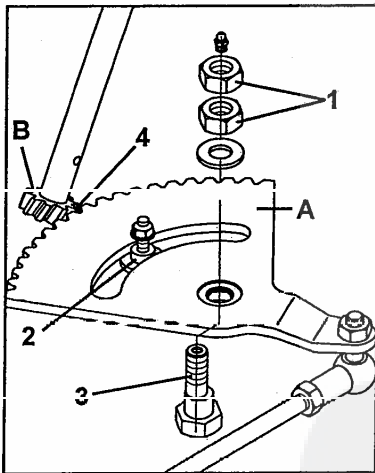

1. Loosen counter nuts (1)
2. Loosen screw (2)
3. Using steering eccentric bolt (3) adjust the mesh of A and B to adjust mesh of A and B. Check mesh along the full range of steering (at both extremes of motion.) Readjust if necessary.
4. Lubricate with a quality grease.
5. Retighten hardware.

Aligning Steering Wheel and Front Wheels:

To align steering wheel and the front wheels:

1. Loosen nut and bolt
2. Position steering arm so it meshes firmly with steering gear assembly.
3. Clean any grass and debris from gear and pinion. Lubricate the gear teeth with a high quality heavyweight grease.
4. Retighten hardware.

WHEEL REPLACEMENT

To remove the wheels:

1. Turn off the mower
2. Lift the tractor and support it on stands
3. Remove the plastic wheel cover, if equipped
4. Remove the retaining clip, the flat washer, and the wheel.

Clean and lubricate the wheel shafts with automotive quality grease before replacing the wheels.

Check the tire air pressure after replacing the wheels and adjust as needed. The tires should only be repaired by an authorized service dealer.

TIRE PRESSURE

Check air pressure in all tires every 25 operating hours. Front tires should be inflated to 1.0 bars (14 PSI). Rear tires should be inflated to 0.7 bars (10 PSI), or as otherwise stated on the tire sidewall.

DISCHARGE CHUTE

The discharge chute must be kept clean and free of debris.

If the discharge chute needs to be removed, all electrical connections to the chute must be disconnected before completely removing the chute. To remove chute:

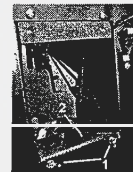

1. Loosen (do not remove) the discharge chute wing nuts (Position 1 above) on the rear collector panel.
2. Free the deck end of the chute from the studs on the mower deck.
3. From behind the unit, pull the chute out towards the top and rear of the mower until electrical connections are exposed. Disconnect the wire.
4. Remove chute completely.
5. Reinstall deck by reversing above procedure.

When reinstalling the chute, make sure the portion of the chute closest to the mowing decks securely attaches to the attachment studs. Reconnect electrical connections to the chute once it has been reinstalled.

FULL BAG DETECTOR

The Full Bag Sensor diaphragm on the inside of the discharge chute must be kept free of accumulated grass and debris. When cleaning the mower, be sure to remove any grass caught between the FBS guard plate and the rubber diaphragm. Accumulated debris can cover the flow sensor and hinder operation.

BELTS

Belts must be kept clean and tensioned correctly at all times. Loose belts lead to premature belt failure and should be tightened before operating the mower.

Even with the proper maintenance and normal operation, belts are subject to wear and should be replaced as needed. Worn or damaged belts must be replaced with only OEM or factory certified components. New belts stretch with use. As belts do not wear at even rate, check tension frequently to ensure maximum belt life.

The use of a belt tension gauge (available from your dealer) is recommended for checking and adjusting belt tension.

DRIVE BELT

Checking Drive Belt Tension

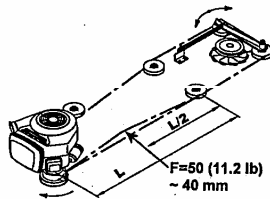

The drive belt should be kept clean and properly tensioned. Over tightening the belt may result in damage to the drive system. Slipping or "squealing" belts should be tightened.

To check for proper tension, use of a belt tension gauge is recommended. Belt should deflect 40 mm (1-1/2") when 50N (11.2 lb-ft.) of force is applied at check point (Figure 13).

Adjusting Drive Belt Tension

1. Remove grass collector and discharge chute
2. Adjust the distance between the end of draw rod (2) and the bracket (1) using adjusting nut (3), as shown in the figure.

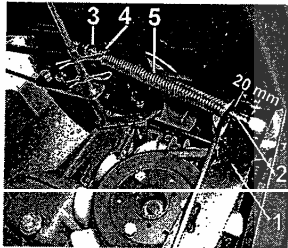

3. Using adjusting nut (4) adjust tension of spring (5) to adjust belt tension. Measure belt tension (3) and adjust if necessary.

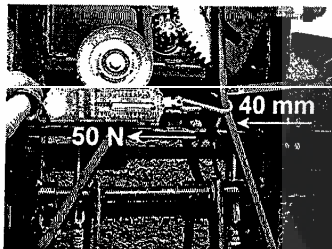

4. Check belt tension, and repeat above steps until proper tension is achieved.

Changing Drive Belt

To change drive belt:

1. Remove mowing deck
2. Remove grass collector and discharge chute
3. Remove left rear wheel

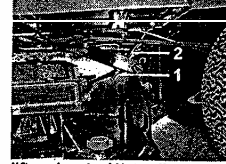

4. Disconnect deck lift rod nuts (1) to disconnect deck lift rods (2) from the mower deck.

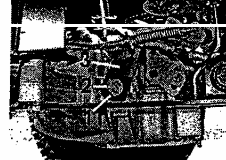

5. Remove cotter pin (1) from crown nut (2) and disconnect brake adapter (3) with the brake draw rod.

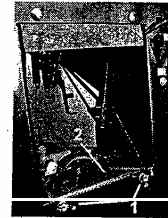

7. Remove wing nuts (1) and remove plate (2)

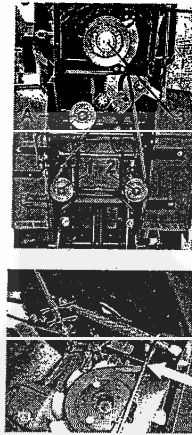

8. Remove belt from pulley (A)
9. Using a wedge, move idler pulley bracket forward to allow enough slack to remove belt from transmission pulley. Remove belt from transmission pulley.
10. Remove idler pulleys 1 and 2, including brackets.
11. Disconnect wiring to and remove electromagnetic clutch.
12. Remove belt from machine.

To install a new belt, reverse the above procedure.

MOWING DECK TIMING BELT

Incorrect tension of the blade timing belt may cause damage to the mowing system and reduce belt life.

Correct Tensions:

40" (102 cm) Decks: Belt must deflect 12mm (1/2") when 65N (14.6 lb-ft.) of force is applied at point 5

48" (122 cm) Decks: Belt must deflect 14mm (1/2") when 65N (14.6 lb-ft.) of force is applied at point 5

Adjusting Tension

The tension of the mowing deck timing belt should be checked periodically. Use of a belt tension gauge is recommended. Adjust tension as follows:

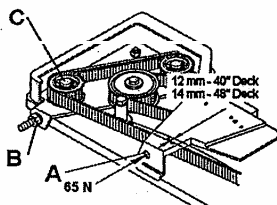

1. Loosen idler pulley (C) bolt on the bottom side of plate.
2. Turn adjustment nut (B) to adjust tension.
3. Check belt for proper tension and repeat above steps until proper tension is achieved.
4. Tighten pulley bolts.

BELT TENSION GAUGE

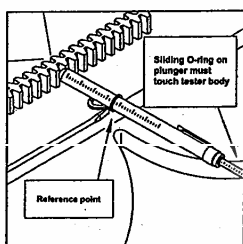
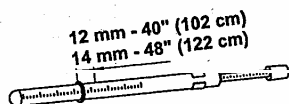

1. Slide o-ring on tester plunger to base of plunger.
2. Insert tester body into checkpoint A until tip contacts belt.
3. Slide o-ring on body ("reference point") until it touches plastic deck cover. Note position.
4. Press tester onto belt until correct deflection achieved. Note position of plunger o-ring.
5. If the plunger o-ring does not indicate 65 N, adjust belt tension and repeat as necessary.

MOWING DECK

Removing

To remove:

1. Disengage PTO, shut off engine, and remove ignition key.
 2. Take the grass container off the mower.
 3. Raise the deck to highest position.
 4. Disconnect the lift assist springs and the belt tensioning springs.
 5. Remove the deck belt from the pulley on the engine.
 6. Remove discharge chute from machine. Slots on the chute attach directly to studs located on the rear of the mowing deck. The chute must clear these studs before it can be removed.
 7. Place deck in lowest position.
 8. Remove the hairpins from the deck linkage pins, and remove deck linkage pins. There are four deck linkage pins connecting the deck - two in the front and two in the rear.
 9. Slide the deck from underneath the machine.
- To install the deck, reverse this process.

Adjusting Deck Pitch (Front to Back)

Front of deck should be 10mm (3/8") lower than rear of deck. To adjust deck pitch:

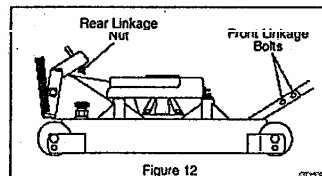

1. Park the mower over a clean and level work surface.
2. Check and adjust tire pressure.
3. Place deck in lowest position.
4. Loosen the front linkage bolts on the left and right deck support linkages.
5. Lift or lower the front lip of the deck so it is approximately 15mm (5/8") from the ground.
6. Tighten front linkage bolts.
7. Loosen rear linkage nuts to lower rear of deck. Tighten nuts to raise rear of deck. Adjust rear linkage nuts until rear lip of deck is 25mm (1") from ground.

Adjusting Deck Level (Side-to-Side)

To check deck level:

1. Park the mower over a clean and level work surface.
2. Check and adjust tire pressure.
3. Place mower deck in highest position.
4. With blades positioned side to side, measure blade tips to ground level on right and left side of deck.

NOTE: To make measuring blade height easier, wrap a wood block (approximately 3 cm x 13 cm) with masking tape. With the end of the block on the ground, mark the block with the mower blade. Measure the distance from the end of the block to the mark.

If measurements are more than 3mm (1/8") apart, adjust deck leveling.

To adjust deck level:

1. On higher side of deck, loosen rear linkage nut to lower rear of deck and re-measure blades side to side.
2. Adjust rear linkage nut until the blade height on the left side equals the blade height on the right side.

Mowing Deck Lift Adjustment

If deck cannot be lifted to all positions, the deck lift system may be incorrectly adjusted.

1. Park the mower over a clean and level work surface.
2. Check and adjust tire pressure.
3. Place deck in lowest position.
4. Loosen nuts (1) until caster wheels are in contact with ground.

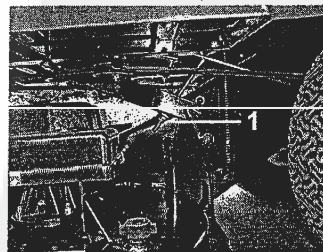

5. Lift deck to highest position and make sure the deck cover does not contact the drive belt.
6. In case the cover does touch the drive belt, lower deck slightly using adjusting bolts (3) to adjust deck position.

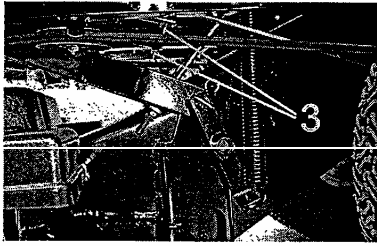

Anti-Scalp Rollers

Use rollers to prevent lawn scalping. DO NOT use rollers to control cutting height.

To adjust roller:

1. Remove retaining clip and pin from roller bracket.
2. Adjust position of roller.
3. Reinstall pin and retaining clip.
4. Repeat steps for remaining rollers.

IMPORTANT: All rollers must be placed in same position.

MOWING BLADES

Keep blades sharp for best mowing performance.

Always wear gloves when handling new or used blades. Never use damaged blades. Check condition of shear bolts. Replace any damaged or missing shear bolts.

Take careful note of the orientation of the blade before removal and during installation. They must be installed in the correct orientation. Hint: Make a few quick notes on a piece of paper, or make a mark connecting the blade and spindle adapter, before removing blades.

Mowing Blade Removal

1. Remove the mowing deck from the mower.
2. Slide the deck from beneath the mower
3. Stand the deck on end to access the blades. Make sure the deck is adequately supported in this position so that it will not fall. Do not place the deck "upside down" (so that the deck is resting on the deck drive system) as this may damage the deck drive system
4. Wedge a block of wood between the blade and deck to prevent the blade from spinning during removal. Do not use excessive force – this may cause damage to the blade or spindles.
5. Loosen and remove the bolts holding the blade to the spindle adapter.
6. Remove the blade from the spindle adapter.

Sharpening Blades:

1. Clamp the blade securely in a vice
2. Dress the cutting edge being careful to not alter the original cutting profile.
3. Perform the above procedure for the other end of the blade.

Balancing Blades

Never use damaged or imbalanced blades. Doing so can lead to serious injury and damage to the machine. All blades should be checked for correct balance prior to installation. Any damaged or imbalanced blades must be correctly balanced or replaced prior to use.

To check for blade balance:

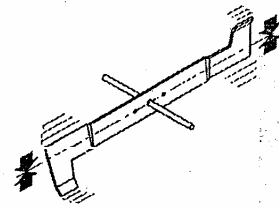

1. Clamp a screwdriver or thin rod horizontally into a vice.
2. Rest the blade on the center mounting hole on the screwdriver/rod parallel to the ground.
3. Let go and watch how the blade spins.
4. If one side drops, remove material from other end. File or grind excess material from the cutting face of the heavy side of the blade. Do not alter the geometry of the blade – always maintain the original profile.
5. Re-check for balance and repeat until the blade is balanced.

Installing 40"(102 cm) Deck Blades

1. Position the blade mounting holes over the spindle mounting holes, taking note to ensure correct orientation.
2. Install and finger tighten the outer mounting bolts. Install the center mounting bolt and finger tighten.
3. Tighten the center mounting bolt to 40-50 Nm. Do not overtighten this bolt as damage to the deck drive system may result. Tighten the outer mounting bolts securely per bolt torque specifications.

Note: The right blade has a left-hand thread.

Installing 48"(122 cm) Deck Blades

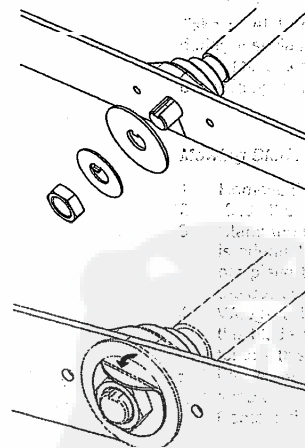

Sharpening Blades:

1. Assemble as shown in illustration above
2. Position the blade mounting holes over the spindle mounting holes, taking note to ensure correct orientation.
3. Install and finger tighten the outer mounting bolts. Install the center mounting bolt and finger tighten.
4. Tighten nut to 60 Nm (44.5 ft.-lbs.) In the absence of a suitable torque wrench, this is approximately ¼ (90°) revolution after initial contact of nut is made (after hand tightening the nut.) Do not overtighten this bolt as damage to the deck drive system may result. Tighten the outer mounting bolts securely per bolt torque specifications.
5. Bend the tab washer (p/n E5149) upwards, with suitable tool such as chisel or screwdriver, against a flat on the nut, as shown in the illustration.

Note: The right blade has a left-hand thread.

IMPORTANT: When mounting spindle adapters to deck, blades must be perpendicular to one another

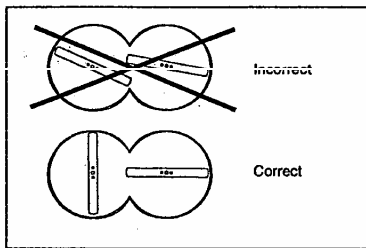

GRASS COLLECTOR

Adjusting Alignment

If rear fender and grass collector do not align, grass collector support brackets may not be positioned correctly.

To adjust alignment:

1. Remove grass collector
2. Loosen bolts (1)
3. Adjust support bracket position so that the gap between the rear fender and the cover of the grass collector is (at least) 5 mm.
4. Tighten bolts

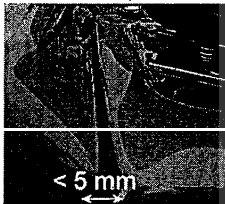
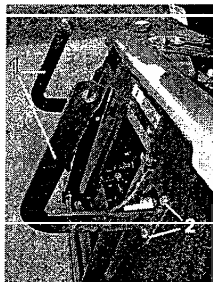

HYDROSTATIC TRANSAXLE

Your transmission is sealed unit and should provide years of reliable service. The fluid level in the transmission must be checked once a month (see lubrication chart) and adjusted if needed. The fluid level should be between 1.25" and 1.62" from the top of the housing for the 329-0650 (333-0650) transmission. Use 20W50 oil.

Please contact your dealer with any other transmission related issues.

Controlling Hydrostatic Oil

If drive system is sluggish, hydrostatic oil may be low. Check hydrostatic oil level monthly and adjust if needed.



1. Remove grass collector and discharge chute
2. Inspect the transaxle for leaks or damage to the housing. If leakage is observed, do not operate until the leakage is repaired.
3. Remove oil fill cover bolt. Measure distance from top of housing to oil level. To avoid oil contamination, check only with a clean instrument. Check the oil level and fill to the correct level if needed.
4. The oil should be between 3.2 and 4.1 cm (1.25" and 1.60") from the top of the axle housing. Use an API classification CG/CD engine oil with a viscosity range equivalent to 20W-50.

Adjusting Transaxle Brake

If braking performance is too light or too hard, transaxle brake may need to be adjusted

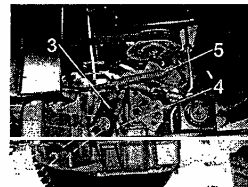

1. Remove rear left wheel
2. Remove cotter pin (1) and adjust crown nut (2) on the transaxle so that gap measured as shown is approximately 0.75 mm.

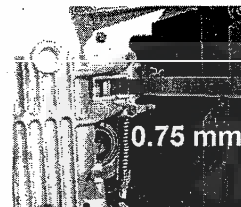

3. With the parking brake disengaged and the brake pedal in the neutral position, the brake adapter (3) should contact and rest against the brake stop (4).
4. If the brake adapter (3) does not touch the brake stop (4), adjust nut (5) until the brake adapter rests against the brake stop.

Adjusting Transaxle Neutral Setting

If machine "creeps" or continues moving with pedal in neutral position, neutral position on transaxle may be incorrectly adjusted or drive pedal neutral position incorrectly adjusted



Adjustment:

Chock front wheels and Jack up rear of machine. Run engine with drive pedal in neutral. Rear wheels should not turn.

This may occur if either the drive pedal linkages are incorrectly adjusted

or if the drive engagement on the hydrostatic transaxle is incorrectly adjusted.

Drive Pedal Linkage Adjustment:

1. Engage parking brake
2. When the parking brake is engaged, the bolt (2) should be in the middle of the slot in adapter (1)
3. If the bolt is not in the middle of the slot, adjust the brake rod adjustment nut (3) until the bolt is positioned in the slot as shown in the picture.

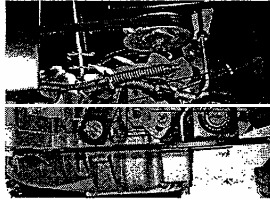

Transaxle Drive Engagement Adjustment:

1. Remove left rear wheel
2. With the parking brake disengaged and the pedal in the neutral position, adjust length of threaded rod (2) with nuts (2) until the transmission drive adapter (1) is in neutral and the wheels do not turn.

Adjusting Transaxle Bypass Valve Engagement

If you are unable to push or pull machine with engine off, or unable to drive with engine running, transmission bypass valve control linkage may need adjustment.

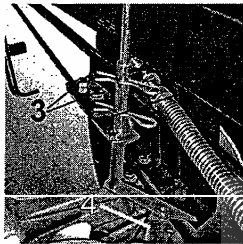

Adjustment:

1. Remove grass collector and discharge chute
2. Put push valve selector (beneath the operators seat) into the "NO PUSH" position
3. Loosen bolt attachments (3)
4. Adjust the position of adaptor (2) so that transmission push valve adapter (4) is at the end of motion range.
5. Tighten bolts (3)
6. Test and readjust if necessary.

LUBRICATION

Once a month, the moving parts of the steering assembly should be lubricated with a high quality, heavy weight grease. Clean linkages of contaminated grease and dirt before applying clean lubricant.

Cables, switches, and other components should be lubricated with water displacing spray lubricants.

Refer to the following lubrication chart for lubrications points and recommended lubricant.

Position	Item	Recommended Lubricant	Lubrication Interval (months)	Total Points
1	Wheel shafts	grease	1	2
2	Vertical axle shafts	grease	1	2
3	Steering (ball) joints	oil	6	4
4	Central axle pivot joint	oil	12	2
5	Steering pinions	grease	1	-
6	Parking brake and drive pedals	oil	1	4
7	Parking brake and drive pedal shafts	grease	1	-
8	Drive pedal linkage	oil	1	1
9	Deck height linkages	oil	1	-
10	Deck height shaft	oil	6	4
11	Deck height adjustment linkage	grease	6	-
12	Power lift actuator	oil	1	1
13	Container Pivot Joints	oil	3	2

Heavyweight automotive quality grease and SAE 30 oil are recommended

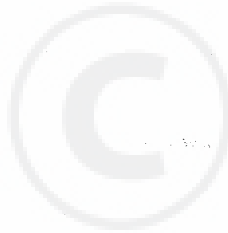

MAINTENANCE CHART

- (10) Before Storage
- (9) Before Each Season
- (8) Every 100 Hours
- (7) Every 50 Hours
- (6) Every 25 Hours
- (5) Monthly
- (4) Weekly
- (3) After First 5 Hours
- (2) After Each Use
- (1) Before Each Use

	1	2	3	4	5	6	7	8	9	10
ENGINE										
Check Engine Oil Level										
Change Engine Oil						*				
Service/Change Spark Plug								*		
Replace Air Filter										
Clean Air Screen	*		*							
Inspect Muffler/Spark Arrestor										
Replace Fuel Filter										
TRANSMISSION & STEERING										
Check Transmission Fluid Level										
Change Transmission Fluid									*	
Adjust Steering Freeplay										
Lubricate Steering Components										
BATTERY AND ELECTRICAL SYSTEM										
Check Battery Fluid Level/Recharge										
Clean Battery and Terminals								*		*
DECK, BLADES, & MOWING SYSTEM										
Sharpen/Replace Blades						*				
Check Blade Mounting Bolts										
Check for Loose Fasteners	*									
Check Belt Tension										
Check Container Netting	*									
Replace Belts										
Replace Netting	as needed									
Adjust Mower Deck Belt	as needed									
Adjust Drive Belt Tension	as needed									
GENERAL										
Check Brake Operation										
Check Tire Pressure	*									
Clean Lawn Tractor	*									
See Lubrication Chart	*									
Check for Loose Fasteners	*									

Recommended Engine Oil: SAE 10W-30
 Recommended Transmission Oil: SAE 20W-50
 * More frequently in hot, dry, or dusty conditions

TROUBLESHOOTING GUIDE

Problem	Correction
Mower cuts ragged or uneven	<p>Mowing very tall or wet grass could adversely affect mowing performance. Adjust deck height to a higher position, reduce mowing speed, and/or let the grass dry.</p> <p>Raise deck height or reduce mowing speed</p> <p>Remove accumulated grass clippings from the underside of the deck</p> <p>Make sure blades are not dull or damaged</p> <p>Make sure all blade attachment bolts are present and tightened appropriately. Tighten the blade mounting screws if needed</p> <p>Make sure the deck is level per manual. See Appendix A.</p> <p>Check deck belt tension. Adjust if necessary</p> <p>Check for damage to mower deck. Repair or replace if necessary</p>
Mower leaves unmowed strip between blades	<p>Mowing very tall or wet grass could adversely affect mowing performance. Adjust deck height to a higher position, reduce mowing speed, and/or let the grass dry.</p> <p>Use a slower tractor speed. Engine should run at full throttle.</p> <p>Make sure blades are sharp and in good condition.</p> <p>Check belt tension. Adjust if necessary.</p>

	<p>Check for damage to mower deck. Repair or replace if necessary</p>
Mower scalps lawn	<p>Check deck height setting and adjust as needed. Scalping is more likely on rough or uneven terrain.</p> <p>Check for damage to mower deck. Repair or replace if necessary</p> <p>Check for bent or damaged blades. Repair or replace if necessary.</p> <p>Check deck leveling and adjust as needed.</p>
Mower does discharge clippings	<p>Remove accumulated grass clippings from the underside of the deck</p> <p>Wet conditions can cause grass to accumulate in and plug the discharge chute. Clean the chute and do not mow very wet grass.</p> <p>Mower speed should be appropriate for grass conditions. Engine should run at full throttle.</p> <p>When mowing very tall grass, first mow with deck in highest position, then mow again with deck at desired height.</p> <p>Check deck belt tension. Adjust if necessary.</p> <p>If blades have been replaced, make sure they have been correctly installed.</p>
Blade drive belt comes off during use	<p>Blade drive belt may suffer internal damage if it comes off during use. If belt comes off after checking all steps below, replace the belt with factory certified replacement.</p> <p>Check for and remove foreign objects which may interfere with belt travel.</p> <p>Check deck belt tension. Adjust if necessary</p> <p>Check the belt guide and idler pulleys. Make sure the guide is not rubbing against the belt, and all idler pulleys function normally.</p> <p>Check mower deck leveling. Adjust as necessary.</p> <p>Check all pulleys in the blade drive system. A bent/damaged pulley could cause problems. Replace if necessary.</p> <p>Check the blade engagement idler assembly for damage or wear. Replace necessary parts.</p>
Blade drive belt slips	<p>If grass is too tall or wet, belt slipping may occur. Adjust the deck height or let grass dry as necessary.</p> <p>Check the blade drive belt for damage or wear. Replace if necessary.</p> <p>Check belt tension per manual. Adjust as needed.</p> <p>Check blade drive belt tension spring. Replace if it is stretched or damaged.</p>
Blade drive belt wears excessively	<p>Check all belt guides to ensure they are not interfering with belt motion.</p> <p>Check for and remove any foreign objects interfering with belt motion.</p> <p>Check for bent or damaged pulleys in the blade drive system. Repair or replace damaged components.</p> <p>Check deck leveling and adjust as needed.</p> <p>Check blade belt tension per manual. Adjust as needed.</p>
Blades will not engage	<p>Inspect belt for damage or wear. Replace if necessary.</p> <p>Check belt tension. Adjust as needed.</p> <p>Check for and remove any foreign materials interfering with belt motion.</p> <p>Check pulley and idler system for wear or damage. Repair or replace damaged/worn components.</p> <p>Contact an authorized service center.</p>
Extreme vibration occurs when blades are engaged	<p>Check blades and make sure they are not bent or damaged or out of balance. Replace if necessary.</p> <p>Check underside of deck for accumulated grass or debris. Clean if necessary.</p> <p>Check blade drive belt for damage and surface irregularities. Replace if necessary.</p> <p>Check for worn or damaged blade engagement parts. Repair and replace parts as needed.</p> <p>Check inner surface of engine drive pulley. If inner surface is rough or split, then pulley should be replaced.</p> <p>Check for loose or damaged engine or deck mounts. Tighten, repair, or replace as needed.</p>
Steering slips or is loose	<p>Check for loose steering sector gear and pinion. If gears are loose, tighten gears.</p> <p>Check for ball joint wear. Replace if needed.</p>
Engine will not turn over	<p>Check starting procedure. Make sure the starting instructions are followed.</p> <p>Check battery for connections and charge. Clean connections or charge as needed.</p> <p>Check fuse.</p> <p>Make visual check of electrical system to make sure all connections and safety switches are secure.</p>

	<p>Check engine according to engine manufacturers manual</p> <p>Have electrical system checked by an authorized service dealer</p>
Engine turns but will not start	<p>Check the starting procedure. Make sure the starting instructions are followed.</p> <p>Make sure the fuel tank is clean and filled with clean, fresh unleaded gasoline.</p> <p>Make sure the throttle is in the fast position and/or choke is engaged.</p> <p>Check the engine according to the engine manual.</p> <p>Check fuel filter for obstructions. Clean or replace fuel filter.</p> <p>Contact an authorized dealer.</p>
Blocked discharge tunnel	Remove the grass container from the tractor and clean the discharge chute.

TECHNICAL SPECIFICATIONS

	MT8-110.25M4	MT8-110.26M4	MT8-110.26H4	MT8-110.28H4	MT8-110.29H4	MT8-112.29H4	MT8-112.49H4
ENGINE							
Manufacturer	Briggs and Stratton	Briggs and Stratton	Briggs and Stratton	Briggs and Stratton	Briggs and Stratton	Briggs and Stratton	Honda
Output - hp (kW)	15.5 (11.6)	18 (13.2)	18 (13.2)	18 (13.4)	20 (14.7)	20 (14.7)	20 (14.7)
Fuel Tank Capacity - liters (gal)	9 (2.4)	9 (2.4)	9 (2.4)	9 (2.4)	9 (2.4)	9 (2.4)	9 (2.4)
TRANSMISSION							
Type	Hydrostatic	Hydrostatic	Hydrostatic	Hydrostatic	Hydrostatic	Hydrostatic	Hydrostatic
Differential	Integrated	Integrated	Integrated	Integrated	Integrated	Integrated	Integrated
Brakes	Integrated	Integrated	Integrated	Integrated	Integrated	Integrated	Integrated
Speed, Forward - km/h (mph)	9.5 (5.9)	9.5 (5.9)	9.5 (5.9)	9.5 (5.9)	9.5 (5.9)	9.5 (5.9)	9.5 (5.9)
Speed, Reverse - km/h (mph)	4.5 (2.8)	4.5 (2.8)	4.5 (2.8)	4.5 (2.8)	4.5 (2.8)	4.5 (2.8)	4.5 (2.8)
CUTTING SYSTEM							
Type	Counter-Rotating	Counter-Rotating	Counter-Rotating	Counter-Rotating	Counter-Rotating	Counter-Rotating	Counter-Rotating
Discharge	Rear	Rear	Rear	Rear	Rear	Rear	Rear
Cutting Width - mm (in)	1020 (40)	1020 (40)	1020 (40)	1020 (40)	1020 (40)	1220 (48)	1220 (48)
Cutting Height - mm (in)	20 - 80 (1.2-3.5)	20 - 80 (1.2-3.5)	20 - 80 (1.2-3.5)	20 - 80 (1.2-3.5)	20 - 80 (1.2-3.5)	20 - 80 (1.2-3.5)	20 - 80 (1.2-3.5)
Cutting Positions	7	7	7	7	7	7	7
Number of Blades	2	2	2	2	2	2	2
Blade Spindles	24 mm spline	24 mm spline	24 mm spline	24 mm spline	24 mm spline	24 mm spline	24 mm spline
Blade Timing Belt	Kevlar reinforced	Kevlar reinforced	Kevlar reinforced	Kevlar reinforced	Kevlar reinforced	Kevlar reinforced	Kevlar reinforced
Deck Material	Welded Steel	Welded Steel	Welded Steel	Welded Steel	Welded Steel	Welded Steel	Welded Steel
Power Take Off	Electro-Magnetic	Electro-Magnetic	Electro-Magnetic	Electro-Magnetic	Electro-Magnetic	Electro-Magnetic	Electro-Magnetic
Mower Wheels	4	4	4	4	4	4	4
Hose Attach Ports	yes	yes	yes	yes	yes	yes	yes
TIRES							
Front	15 x 6.00-6	15 x 6.00-6	15 x 6.00-6	15 x 6.00-6	15 x 6.00-6	15 x 6.00-6	15 x 6.00-6
Rear	20x10.00-8	20x10.00-8	20x10.00-8	20x10.00-8	20x10.00-8	20x10.00-8	20x10.00-8
CHASSIS							
Frame Type	Steel Tube	Steel Tube	Steel Tube	Steel Tube	Steel Tube	Steel Tube	Steel Tube
Front Axle	Cast Iron	Cast Iron	Cast Iron	Cast Iron	Cast Iron	Cast Iron	Cast Iron
Seat	Hi-Back	Hi-Back	Hi-Back	Hi-Back	Hi-Back	Hi-Back	Hi-Back
COLLECTION CONTAINER							
Emptying Control	EZ Manual	EZ Manual	PowerLift	PowerLift	PowerLift	PowerLift	PowerLift
Container Volume L (gal.)	300 (80)	300 (80)	410 (108)	410 (108)	410 (108)	410 (108)	410 (108)
DIMENSIONS							
Length - mm (in.)	2590 (102.2)	2590 (102.2)	2590 (102.2)	2590 (102.2)	2590 (102.2)	2590 (102.2)	2590 (102.2)
Width - mm (in.)	1065 (41.9)	1065 (41.9)	1065 (41.9)	1065 (41.9)	1065 (41.9)	1065 (41.9)	1065 (41.9)
Height - mm (in.)	1080 (42.5)	1080 (42.5)	1080 (42.5)	1080 (42.5)	1080 (42.5)	1080 (42.5)	1080 (42.5)
Wheel Base - mm (in.)	1200 (48)	1200 (48)	1200 (48)	1200 (48)	1200 (48)	1200 (48)	1200 (48)
Wheel Spacing - mm (in.)	735 (28.9)	735 (28.9)	735 (28.9)	735 (28.9)	735 (28.9)	735 (28.9)	735 (28.9)
Turning Radius, Left - mm (in.)	1965 (77.4)	1965 (77.4)	1965 (77.4)	1965 (77.4)	1965 (77.4)	1965 (77.4)	1965 (77.4)
Turning Radius, Right - mm (in.)	2165 (85.2)	2165 (85.2)	2165 (85.2)	2165 (85.2)	2165 (85.2)	2165 (85.2)	2165 (85.2)
Actual Weight - kg (lbs.)	305 (672)	305 (672)	305 (672)	305 (672)	305 (672)	305 (672)	305 (672)
ELECTRICAL SYSTEM							
Voltage	12 V	12 V	12 V	12 V	12 V	12 V	12 V
Battery	12V / 35Ah-290 cca	12V / 35Ah-290 cca	12V / 35Ah-290 cca	12V / 35Ah-290 cca	12V / 35Ah-290 cca	12V / 35Ah-290 cca	12V / 35Ah-290 cca
Hour Meter	optional	optional	optional	yes	yes	yes	yes
Controls	PTO	PTO	PTO	PTO	PTO	PTO	PTO
Headlights	Headlights	Headlights	Headlights	Headlights	Headlights	Headlights	Headlights
Brake	Brake	Brake	Brake	Brake	Brake	Brake	Brake
Seat	Seat	Seat	Seat	Seat	Seat	Seat	Seat
Bagger	Bagger	Bagger	Bagger	Bagger	Bagger	Bagger	Bagger
Voltage	Voltage	Voltage	Voltage	Voltage	Voltage	Voltage	Voltage
FBS	FBS	FBS	FBS	FBS	FBS	FBS	FBS

MODEL	Engine		Operating Noise Levels		Vibration	
	Manufacturer	Rated Power	Average In Operating Area (dB)	Direct (dB)	Seat ¹ RMS Average (m/s ²)	Seat ¹ RMS Average (m/s ²)
MT8-110.25M4	B & S	15.5 HP	85.5	100	0.61	
MT8-110.26M4	B & S	18 HP	84.6	100	0.68	
MT8-110.26H4	B & S	18 HP	84.6	100	0.68	
MT8-110.28H4	B & S	18 HP	84.3	100	0.69	
MT8-110.29H4	B & S	20 HP	84.3	100	0.69	
MT8-112.29H4	B & S	20 HP	86.7	105	0.69	
MT8-112.49H4	Honda	20 HP	86.5	105	0.69	

¹ These values represent vertical vibration behind RMD acceleration transferred to the steering wheel did not exceed 2.5 m/s²
 Test Conditions: Test Duration: 2 000 min.
 Moving Speed: 4 km/h
 Height of Cut: 80 mm

Testing Regulation: IEC 60536: 60536: 60536

WIRING COLOR CODE							
Number	Color	Number	Color	Number	Color	Number	Color
1	White	11	Black	20	White	28	Brown
2	Red	12	Blue	21	White	29	Brown
3	Black	14	Black	22	White	30	Yellow
5	Red	15	Black	23	White	34	Red
6	Red	16	Blue	24	White	35	Red
7	Red	17	Brown	25	Green	36	Red
8	Red	18	Yellow	26	Blue	37	White
10	Gray	19	Green	27	Gray		

