



EuroGarden

www.eurogarden.com

OPERATING INSTRUCTIONS BIOLOGICAL PART WASHER



Instructions on: www.instructionsow.com

LIST OF CONTENTS

1	INFORMATIONS	3
1.1	PRODUCT REFERENCES	3
1.2	WARNINGS.....	3
1.3	GENERAL INFORMATION	4
1.4	HANDLING / TRANSPORTING / MOVING THE PARTS WASHER.....	4
1.5	CHARACTERISTICS.....	5
2	PREPARING THE PARTS WASHER	6
2.1	PREPARATION & INSPECTION	6
2.2	PUTTING ELEMENTS INTO POSITION	6
2.3	FILLING THE PARTS WASHER.....	6
3	CONTROL BOX	7
4	START-UP	8
4.1	USING THE PARTS WASHER:	8
4.2	USING THE PARTS WASHER:	8
4.3	BOOST MODE (TEMPORARY TEMPERATURE INCREASE OF 5 °C).....	9
4.4	ECO MODE (TEMPORARY REDUCTION IN TEMPERATURE DOWN TO 30 °C).....	9
4.5	SOAKING	10
5	TANK	11
6	MEMO	12
7	VIEWING & MODIFYING PARAMETERS	13
7.1	PARAMETER-VIEWING MODE	13
7.2	CHANGING PARAMETERS.....	14
8	MAINTENANCE	15
8.1	REGULAR SERVICING.....	15
8.2	ELECTRICAL DIAGRAM	15
8.3	EXPLODED VIEW	16
8.4	SPARE PARTS LIST.....	17
9	WARRANTY	17
10	WASTE MANAGEMENT OF THE SOLUTION AND THE UNIT	18
10.1	WASTE MANAGEMENT OF THE SOLUTION.....	18
10.2	WASTE MANAGEMENT OF THE UNIT.....	18
	APPENDIX 1 : DIAGNOSIS	19
	APPENDIX 2 : REMOVING THE ELECTRICS KIT	20
	20
	APPENDIX 3 : DISMANTLING THE PUMP	21
	21
	APPENDIX 4 : REASSEMBLY THE ELECTRIC KIT IN THE PARTS WASHER	22
	APPENDIX 5 : PIECES DETACHEES	23
	NOTES :	25

1 INFORMATIONS

We thank you for acquiring this biological, solvent-free part washer. The parts washer unit combines the action of a neutral pH water-based cleaning solution with tablets of special micro-organisms that biodegrade hydrocarbons and regenerate the cleaning bath.

1.1 PRODUCT REFERENCES

BLUELIQUID : Cleaning solution for which the washer has been adapted.
 BLUETABLET: Micro-organism tablet.
 OCEAN WAVE: Degreasing parts washer.

1.2 WARNINGS

CAUTION

Please read these instructions carefully before using the unit

- 1- The parts washer must **ONLY** be connected to a 230 Volt supply with a ground terminal and ground fault circuit interrupter. Maximum power consumed by the parts washer is 1,100 W.
- 2- Do not use electric extension leads.
- 3- Unplug the power plug for all maintenance actions on the parts washer: draining, cleaning, intervention on the electrical box...
- 4- **Do not pour any pollutants (solvent, oil, grease, engine oil, diesel fuel or petrol) directly into the parts washer.**
- 5- **Never add or pour in any products such as solvents, biocides or disinfectants, alcohols, halogenated agents, inflammable products, acid, bases, boiling water, esters or toxic products. Pouring these products into the parts washer may destroy its internal organs and be dangerous for health.**
- 6- **Empty the parts to be cleaned of any flammable or combustible material before cleaning them. Even small quantities can create a fire.**
- 7- The operator must use gloves and safety glasses
- 8- To work with a complete security, this equipment must be enlightened with a minimum lighting of 100 LUX.
- 9- Do not modify any elements on the parts washer. It has been designed for use with our cleaning solution and our micro-organism tablets.
- 10- Leave the parts washer switched on to maintain the oxygenation and temperature levels required for the hydrocarbon-degrading micro-organisms to develop satisfactorily.
- 11- Low level detection: The parts washer is equipped with an automatic low-level control system. It runs with a liquid level of between 45 and 80 liters, when the level drops below 45 liters, the pump and solution heater stop automatically. In this case, the level must be topped up with 20 or 40 liters of our ready-to-use degreasing solution and micro-organism tablets.
- 12- After electric power is restored following the power outage, the fountain will automatically operate.
- 13- Do not dismantle the pump or any other components without disconnecting the parts washer and leaving the liquid a sufficient time to cool down.
- 14- Limit soaking time for all sensitive metals. Never leave a part to soak over-night.



1.3 GENERAL INFORMATION

The parts washer meets all safety requirements stipulated in the following directives:

- "Machines" directive 2006/42/EC;
- "Low voltage" directive 2014/35/UE;
- "Electromagnetic compatibility" . 2014/30/UE

The manufacturer confirms that the device is in conformity with the 2006/45/CE directives under provided that no modification is made on this device.

For assistance, please contact your commercial agent and with every request specify the serial number glued to the back of the machine:

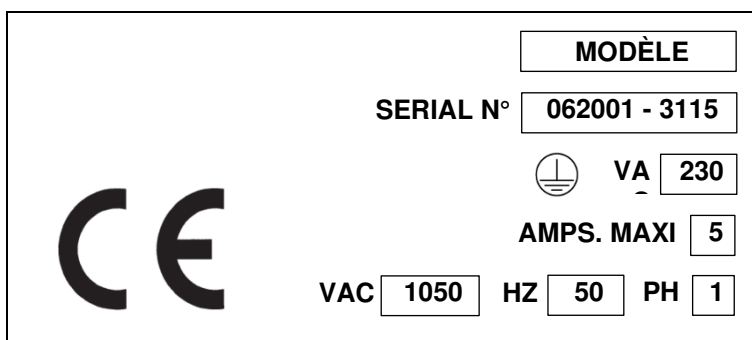

1.4 HANDLING / TRANSPORTING / MOVING THE PARTS WASHER

- For moving or transporting the parts washer, drain it into empty cleaning solution cans (See procedure §5). It weighs 26 kg when empty.
- Place the parts washer vertically on a 600 x 800 mm palette (The parts washer should never be transported lying flat).
- Protect the parts washer with its cardboard packaging.
- Ring the parts washer or film the palette to prevent it parts washer from tipping over during transport.

1.5 CHARACTERISTICS

Maximum power	1050 watts.
Noise level	< 50 dBa.
Weight when empty (without cleaning solution)	26 Kg
Tank material	Low density polyethylene (LDPE)
Power supply required	230 V + T Ground, protected by a 30mA fault circuit breaker
Nominal operating temperature	38°C
Overall dimensions	795 x 600mm H:1100mm (cover closed)
Usable cleaning tank dimensions	690 x 430 x 190 mm
Filtration	Filtre panier Inox 700µ / filtre chaussette 50µ
Tank start-up capacity	60 à 80 liters
Soak-tank capacity	11 liters. Hauteur de trempage 14 cm.
Low-level switch-on without soaking e	45 liters in the tank.
Low-level switch-on with soaking	56,5 liters (45 liters in the tank + 11 liters in the soak-tank + 0.5 liters of product in the piping).
Tool-holder flow with brush	4 liters/mn

ELECTRICITY CONSUMPTION *

*MEASUREMENTS MADE OVER 24 HOURS WITH THE BATH AT 38° AND CONTAINING 50 LITERS OF PRODUCT

At an ambient temperature of 18 °C	consumption is 210 w/h with 50 liters of product.
At an ambient temperature of 23 °C	consumption is 160 w/h with 50 liters of product.
With 12 h in ECO mode	consumption is reduced by 25 % over 24h.

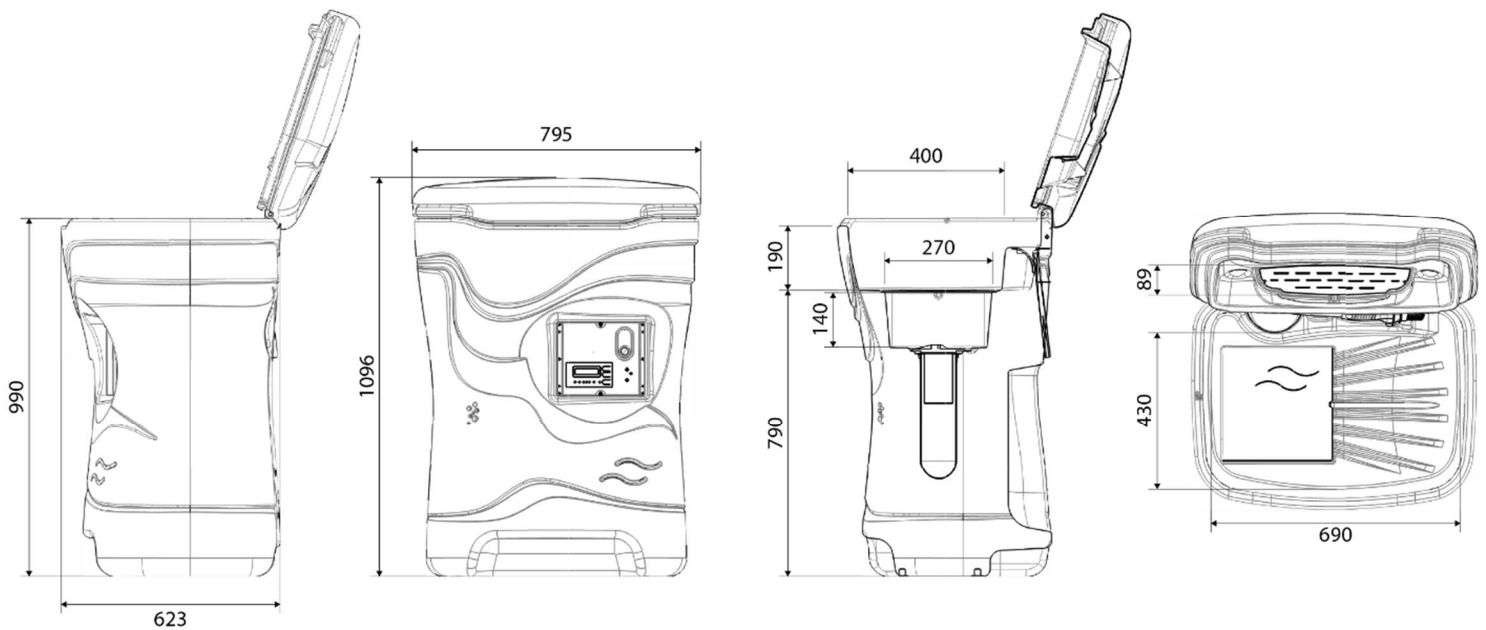

2 PREPARING THE PARTS WASHER

2.1 PREPARATION & INSPECTION

- Remove the cardboard packaging from the parts washer.
- Check that:
 - . The parts washer has not suffered any damage during transport and installation.
 - . The power cable is in good condition. The grommet is correctly in position on the back plate:

2.2 PUTTING ELEMENTS INTO POSITION

- 1- The sock filter must be firmly in position at the bottom of its housing.
- 2- **Insert the stainless steel filter by rotating it.**
- 3- Put the rubber bung:
 - . Ribs underneath : opened.
 - . Ribs above : closed for soaking operation.

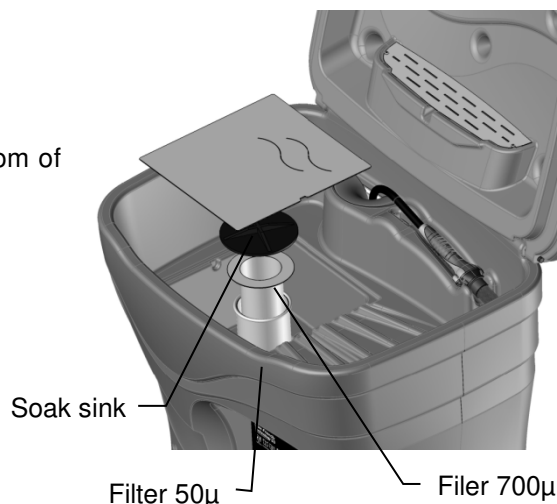
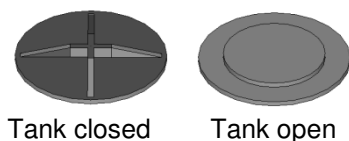

2.3 FILLING THE PARTS WASHER

- 1- Empty the cans into the tank.

CAUTION

Do not throw the empty cans away. They may be useful for recovering the cleaning solution if ever the unit needs to be drained.

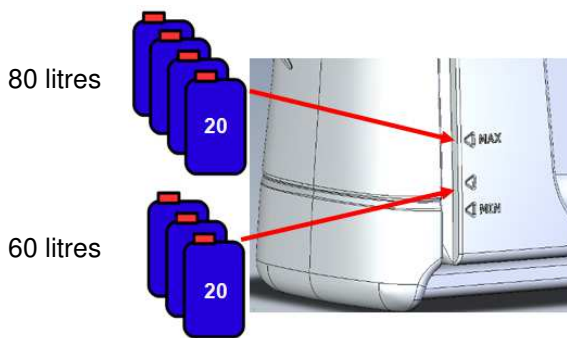

- 2- Insert a micro-organism tablet into the rectangular opening provided for the purpose.

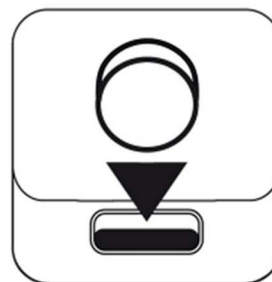

- 3- Note the date on the servicing datasheet.

3 CONTROL BOX

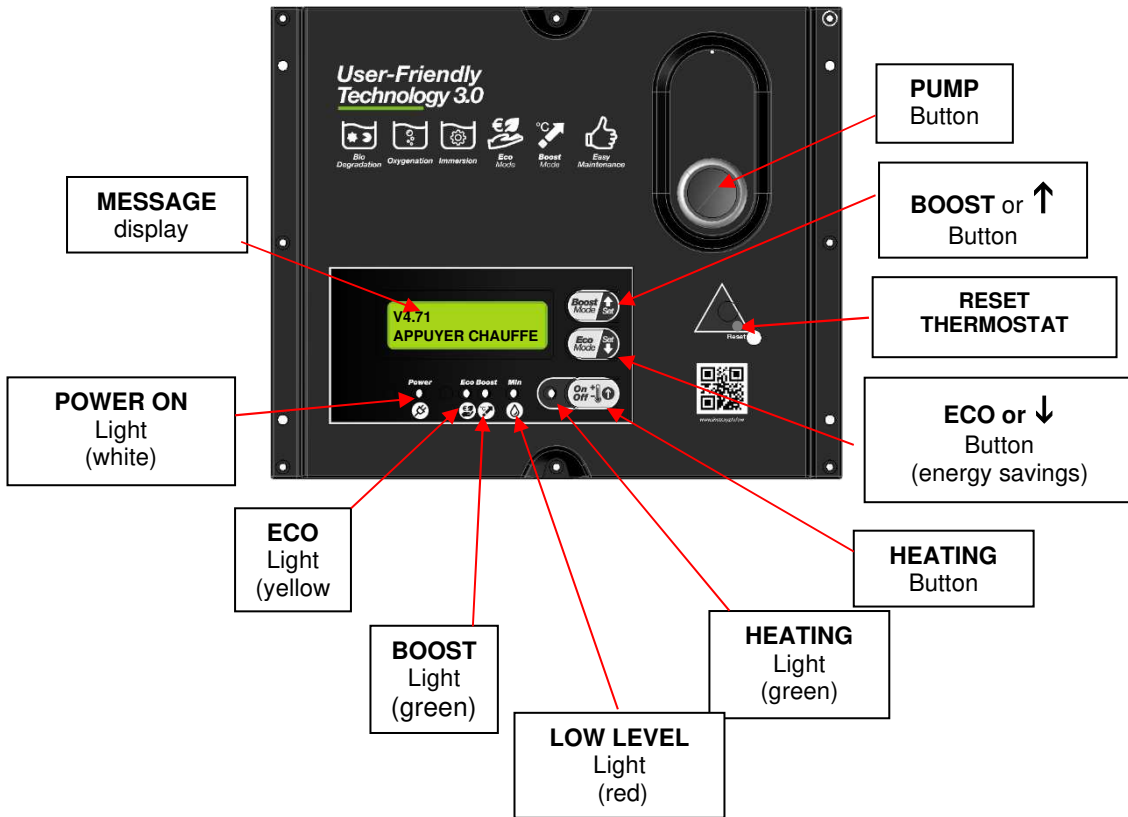

4 START-UP

4.1 USING THE PARTS WASHER:

After the parts washer has been filled with cleaning solution, switch on the Part Washer. Then, push the **HEATING** button until the operating temperature has been reached.

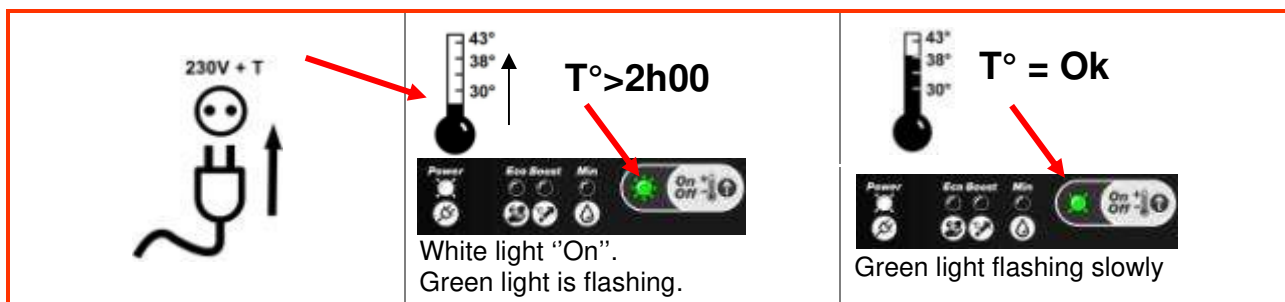

4.2 USING THE PARTS WASHER:

- 1- Draining the part into a suitable container of all flammable, combustible materials and products listed in paragraph 1.2 (n°4, 5 and 6).
- 2- Press the pump control button
- 3- Place the part on the sink
- 4- Clean your part with the brush

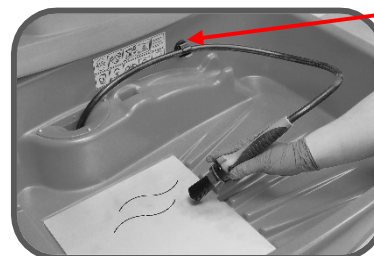
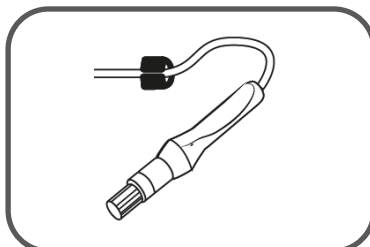

Tool-holder hose clip







A clip is provided to make it easier to guide the tool-holder hose.

CAUTION

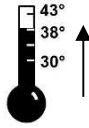
this clip is not designed for attaching the tool-holder !







4.3 BOOST MODE (temporary temperature increase of 5 °C)

The higher temperature is to be used when severely fouled parts need to be cleaned.

	 <p>25mn</p>  <p>Voyant BOOST clignotant. Voyant CHAUFFE fixe.</p>	 <p>T° = 43°</p>  <p>Température atteinte -> arrêt chauffe. Voyant BOOST fixe. Voyant CHAUFFE fixe.</p>	 <p>T° = 38°</p>  <p>Voyant vert clignotant lent quand la température revient à 38°C.</p>
---	---	--	--

4.4 ECO MODE (TEMPORARY REDUCTION IN TEMPERATURE DOWN TO 30 °C)

ECO mode enables the temperature of the bath to be reduced for **reducing electricity** consumption for 11 h*. Beyond this time, the temperature will return to its normal operating level.

	 <p>La température diminue jusqu'à 30°C</p>  <p>Voyant CHAUFFE éteint. Voyant ECO clignotant lent.</p>	 <p>T° = 30°C</p>  <p>Température atteinte -> Maintien de la température pendant 11 heures*</p>	 <p>T° = 38°C La température remonte jusqu'à 38°C</p>  <p>Voyant vert clignotant puis, voyant vert clignotant lent quand la température de 38°C est atteinte.</p>
---	--	--	---

* time adjustable – see paragraph **Erreur ! Source du renvoi introuvable.**

4.5 SOAKING



CAUTION

- Carry out tests for validating the cleaning protocol (compatibility of materials, soaking time, etc.), especially for sensitive metals such as zinc, brass and aluminium alloys (including those containing silicon).
- *Never leave a part to soak over-night.*
- *Limit soaking time to a minimum.*

SOAKING OPERATION:

- 1- Close the soaking area with the rubber bung, ribs above.

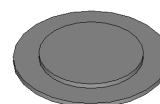
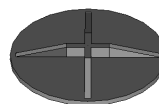
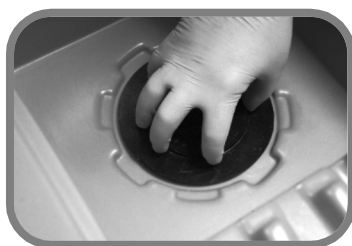

Tank closed

Tank open

- 2- Put the part in the tank.
- 3- Close the soak-tank with the rectangular cover.
- 4- Press the pump control button to fill the tank and leave it in operation so that the solution is maintained at the right level for soaking.

CAUTION

- Check that there is no residue (chips, sand, etc.) in the area where the plug is to be placed. Clean with the brush if necessary.
- Make sure that there is nothing blocking the overflow opening.

- 5- When soaking operation is over, return the rubber bung



5 TANK



LIQUID LEVELS:

Level-checking: Unscrew the drain plug to let air enter the top of the hose.

- 80 liters: Top filling level (upper arrow).
- 60 liters: 60L filling level (middle arrow).
- 45 liters: Low-level detection level (lower arrow).



45 litres (MIN)



Level at about 55 litres



80 litres (MAX)

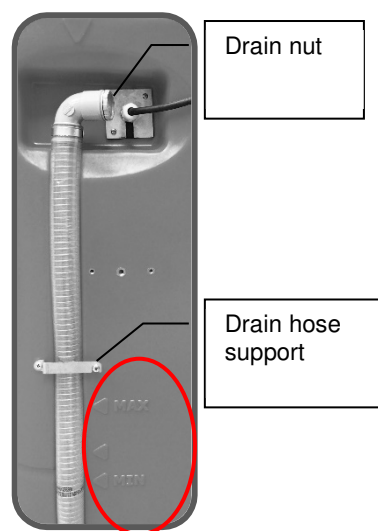

Drain nut

Drain hose support

CAUTION









There must be 56 liters of liquid in the machine for using the soak function and remaining above the minimum level.



DRAINING:

- 1- Lift the parts washer up (on a pallet, pallet-jack, ...).
- 2- Undo the drain hose support element at the back of the parts washer.
- 3- Put an empty can in position ready for use.
- 4- Remove the plug on the hose and pour the used product into the can(s).
- 5- The product must be recycled as per regulations in force.
- 6- Clean the tank if necessary.

6 MEMO







- Nominal operating temperature: Operating temperature at 38 °C +/- 1 °C.
- BOOST temperature: Nominal temperature + 5°C, limited to 45 °C.
- ECO temperature: 29 °C / 30 °C.

L I G H T S	H E A T I N G		When the green light is OFF, the heating is off.
			When the green light flashes at normal speed, the bath is being heated.
			When the green light is on and flashes at long intervals (ON for 0.1 s, OFF for 2.5 s) this indicates that the bath is being maintained at nominal temperature.
	L E V E L S		When the red light is OFF, there is enough liquid in the system.
			When the red light is ON, the liquid level is low. → Extra product must be added.
	B O O S T		When the green BOOST light is flashing, the temperature is rising above its normal operating level.
		When the green BOOST light is ON and steady and the HEATING light is also ON and steady, the BOOST temperature has been reached and the temperature of the bath is higher than its normal operating temperature..	
		When the orange light flashes slowly, the parts washer is in ECO mode.	

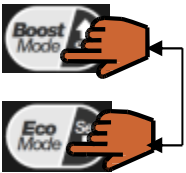
B U T T O N S	B O O S T		<ul style="list-style-type: none"> - BOOST ON/OFF (Increases the HEATING temperature by 5 °C above the nominal operating temperature). - Increases the value of the parameter (parameter setting mode)
	E C O		<ul style="list-style-type: none"> - ECO ON/OFF (Lowers the temperature down as far as 30 °C). - Reduces the value of the parameter (parameter setting mode)
	H E A T I N G		<ul style="list-style-type: none"> - HEATING ON/OFF - Validates the parameter - Safeguards the parameter - Exits the parameter-setting mode (Press for over 2seconds)

7 VIEWING & MODIFYING PARAMETERS.

7.1 PARAMETER-VIEWING MODE









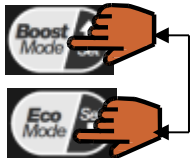

	Control		Message on display screen																
E N T R Y		<p>To enter the parameter-viewing mode, press sharply on the 2 BOOST and ECO buttons at the same time.</p> <p>The bath temperature and the length of operation in ECO mode will be displayed.</p>	<table border="1" style="width: 100%;"> <tr> <td style="width: 50%;">V4.5</td> <td style="width: 50%;">37°C</td> </tr> <tr> <td>ECO TIME</td> <td>18H</td> </tr> </table>	V4.5	37°C	ECO TIME	18H												
V4.5	37°C																		
ECO TIME	18H																		
E V E N T S	  	<p>The "EVENTS" message will appear by pressing the °C -ON/OFF button</p> <p>Press the ↓ button for viewing the events that have been memorized.</p> <p>→ If no events have occurred over the last 48 hours, a "No error" message will be displayed.</p> <p>→ If an event has occurred over the last 48 hours, the first event will be displayed.</p> <p>- By pressing the ↓ button a second time, the time since the event will be displayed.</p> <p>- By pressing the ↓ button a third time, the next event will be displayed.</p>	<table border="1" style="width: 100%;"> <tr> <td style="width: 50%;">V4.5</td> <td style="width: 50%;">37°C</td> </tr> <tr> <td>EVENTS</td> <td></td> </tr> </table> <table border="1" style="width: 100%;"> <tr> <td style="width: 50%;">V4.5</td> <td style="width: 50%;">37°C</td> </tr> <tr> <td>No error</td> <td></td> </tr> </table> <table border="1" style="width: 100%;"> <tr> <td style="width: 50%;">V4.5</td> <td style="width: 50%;">37°C</td> </tr> <tr> <td>ADD PRODUCT</td> <td></td> </tr> </table> <table border="1" style="width: 100%;"> <tr> <td style="width: 50%;">V4.5</td> <td style="width: 50%;">37°C</td> </tr> <tr> <td>01:35:20</td> <td></td> </tr> </table>	V4.5	37°C	EVENTS		V4.5	37°C	No error		V4.5	37°C	ADD PRODUCT		V4.5	37°C	01:35:20	
V4.5	37°C																		
EVENTS																			
V4.5	37°C																		
No error																			
V4.5	37°C																		
ADD PRODUCT																			
V4.5	37°C																		
01:35:20																			
L A N G U A G E S		<p>Press the °C -ON/OFF button for viewing the language.</p>	<table border="1" style="width: 100%;"> <tr> <td style="width: 50%;">V4.5</td> <td style="width: 50%;">37°C</td> </tr> <tr> <td>ITALIAN</td> <td></td> </tr> </table>	V4.5	37°C	ITALIAN													
V4.5	37°C																		
ITALIAN																			
E X I T	 <p style="text-align: center;">2 sec</p>	<p>Press the °C -ON/OFF button for 2 seconds to exit the viewing mode.</p> <p>→ If no buttons are pressed the unit will return to normal mode after 10 s.</p>																	

7.2 CHANGING PARAMETERS



CAUTION

Before entering the parameter-setting mode, HEATING must be switched off (HEATING light OFF).

	Control		Message on display screen
E N T R Y	 2.5 seconds	<p>To enter the parameter-setting mode: Press for 2.5s on the BOOST and ECO buttons at the same time.</p> <ul style="list-style-type: none"> → The bath temperature and the time of operation in ECO mode will be displayed. → "MODIF" will be displayed as long as the parameter-setting mode is activated. 	<div style="border: 1px solid black; padding: 5px; width: fit-content;"> V4.5 MODIF 37°C ECO TIME 11H </div>
E C O		<p>Modifying ECO time: Press button  or button  for modifying the length of ECO time. If no change is required, press the °C - ON/OFF button.</p>	<div style="border: 1px solid black; padding: 5px; width: fit-content;"> V4.5 MODIF 37°C ECO TIME 14H </div>
		<p>The parameter for the ECO mode TIME is safeguarded and the EVENT message is displayed by pressing the °C - ON/OFF button</p> <p>(→ Press the °C - ON/OFF button for 2s to exit the parameter-setting mode).</p>	
E V E N T S		<p>Event-viewing: Use identical to the EVENT section in § Erreur ! Source du renvoi introuvable..</p> <p>The language parameter is displayed by pressing the "ON/OFF button.</p> <p>(→ Press the °C - ON/OFF button for 2s to exit the parameter-setting mode).</p>	<div style="border: 1px solid black; padding: 5px; width: fit-content;"> V4.5 MODIF 37°C EVENTS </div>
L A N G U A G E S		<p>Changing languages: The different languages are displayed by pressing the  or  buttons.</p> <p>The "language" parameter is safeguarded by pressing the °C - ON/OFF button. The "ECO TIME" message will be displayed</p>	<div style="border: 1px solid black; padding: 5px; width: fit-content;"> V4.5 MODIF 37°C ITALIAN </div> <div style="border: 1px solid black; padding: 5px; width: fit-content; margin-top: 10px;"> V4.5 MODIF 37°C ECO TIME 14H </div>
E X I T		<p>Press the °C - ON/OFF button for 2s to exit the parameter-setting mode.</p> <p>→ If no buttons are pressed the unit will return to normal mode after 15 s.</p>	<div style="border: 1px solid black; padding: 5px; width: fit-content;"> V4.5 37°C ADD PRODUCT </div>

8 MAINTENANCE

8.1 REGULAR SERVICING

- Clean the filters whenever they are clogged so as to make sure that the product flows into the tank correctly
- Periodically clean the heating element, especially if there are deposits on the surface of the heating element. Failure to do so may cause the heater to stop working.
- Add micro-organism tablets as per the schedule on the servicing datasheet supplied with the machine.

CAUTION

Unplug the power supply for all maintenance action on this machine: draining, cleaning, intervention on the electrical box....

8.2 ELECTRICAL DIAGRAM

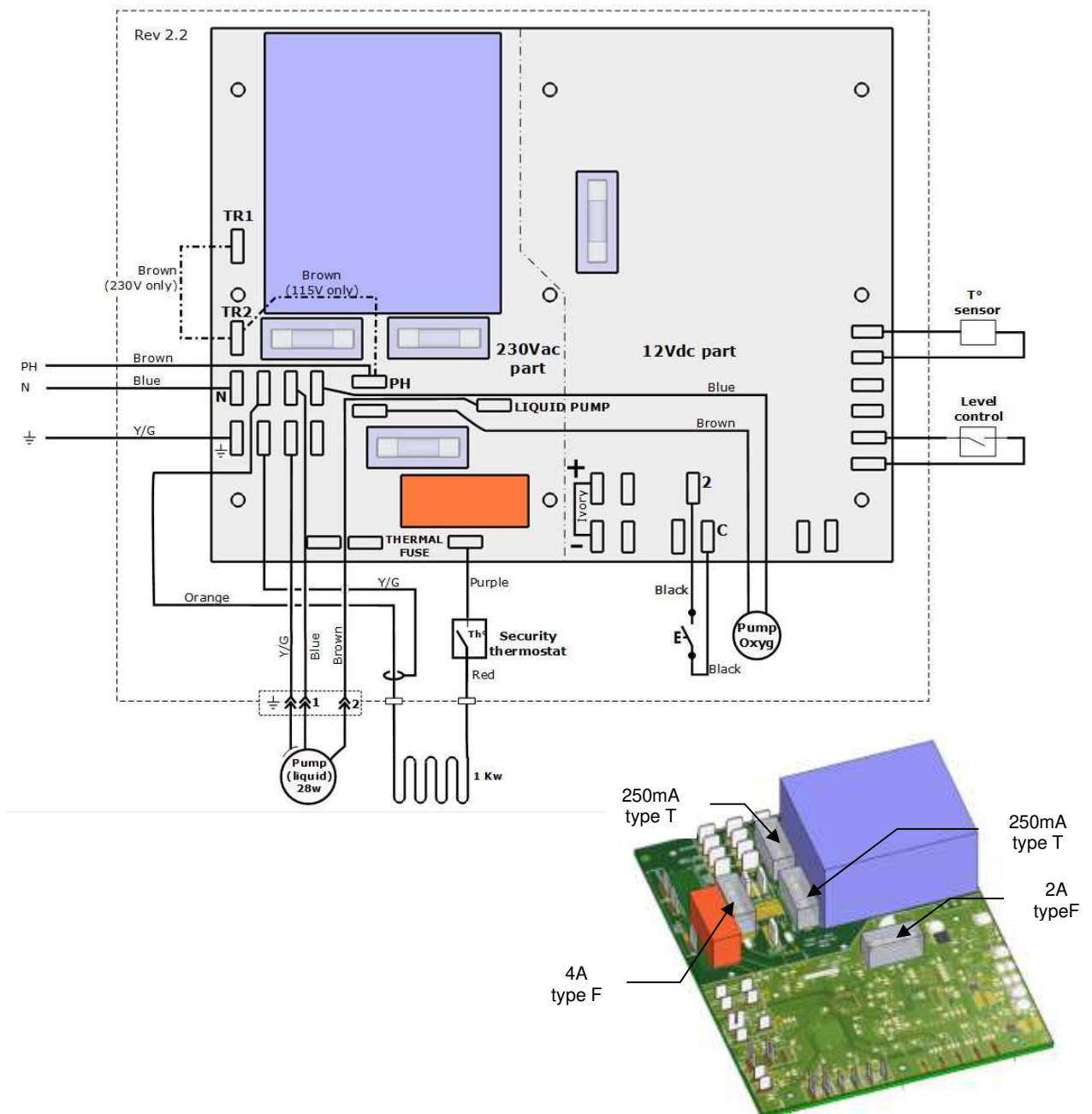

8.3 EXPLODED VIEW

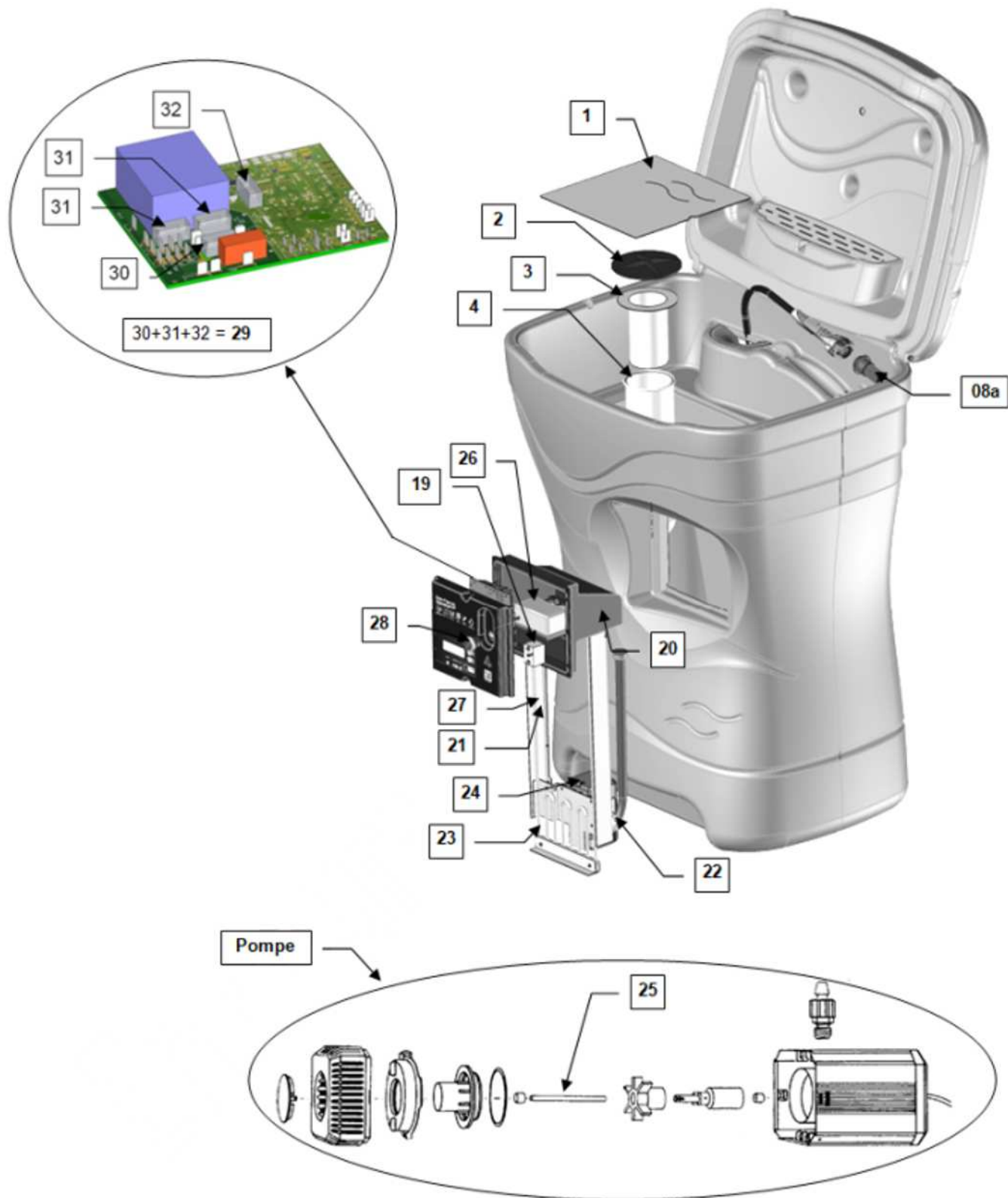

8.4 SPARE PARTS LIST

N°	Description	Reference
01	Soak tank cover	CSEQFOC 065-001
02	Soak tray stopper	CSEQFO 000349
03	Basket filter 700µ	CSEQFO 000289
04	Pocket filter 50µ	CSEQFO 000125
05	Tool holder set FS01	CSEQFO 000111-3
06	Connector Quick JB	CSEQFO 000103
08a	Screwable brush – Hard Brush FO 5/10e°	CSEQFO 000102-4
08b	Screwable brush – Soft Brush FO 4/10e° (option)	CSEQFO 000102-3
19	Thermostat de sécurité	CSEQFO 000540
20	Electric kit FS01 (without pump)	CSEQFO 00055-1-REV2
21	Temperature sensor	CSEQFO 000590
22	FS00 Level detector	CSEQFO 0000529
23	FS01 Resistance	CSEQFO 000036
24	Pump assembly	CSEQFO 000190-1
25	Pump axis	CSEQFO 000345
26	Air pump	CSEQFO 000187-1
27	Air pump hose	CSEQFO 000282
28	Push button	CSEQFO 000589
29	Fuses kit (250mA T, 2A F, 4A F, 8A)	CSEQFO 000011
30	Electronic card	CSEQFO 000100-1

9 WARRANTY

All parts on the parts washer are guaranteed for 1 year excepting normal wear parts (brush, filters, hoses, etc.) and any parts that may have been damaged by incorrect use, negligence or accident. The guarantee will run as from the parts washer's date of invoice.

The degreasing parts washer has been designed for use as described in the operating instructions. Any modification made to the parts washer will lead to the guarantee being declared null and void. This also applies if any consumables are used other than those indicated in paragraph 1.1.

The manufacturer cannot be held in any way liable for any damage caused by using the parts washer in any way other than the way recommended in the operating instructions, in technical datasheets and in the safety data concerning associated products.

The manufacturer reserves the right to modify the design of his products for improving them at any time.

10 WASTE MANAGEMENT OF THE SOLUTION AND THE UNIT







10.1 WASTE MANAGEMENT OF THE SOLUTION

Solution cannot be directly placed into pipings or traditional waste. User must liaise with waste management companies.

10.2 WASTE MANAGEMENT OF THE UNIT

At the end of life of the unit, user must proceed elimination of the unit in accordance with the regulations. User should take care of the general cleaning elements and separate parts constituting the parts washer: stainless steel parts, rubber parts, electronic card... These parts should then be sent or collected by specialised waste management companies.

APPENDIX 1 : DIAGNOSIS

Problem	Possible causes	Action
<p>Nothing runs. No lights are ON. The air pump does not run (no noise comes from the kit)</p> 	<p>The parts washer is not connected to the mains, or the electrical supply to the workshop is faulty.</p>	<p>Plug in the unit, or call for maintenance staff.</p>
<p>Nothing runs. No lights are ON. The air pump does not run (but noise comes from the kit)</p> 	<p>One of the 2 fuses inside the control box has blown (fuses no. 17).</p>	
<p>The heating does not run. The pump does not run The °C light is OFF. The red "MIN" light is ON.</p> 	<p>There is not enough product.</p>	<p>Add product Press the heating button.</p>
<p>Heating does not run. The pump runs. The °C light is OFF. The red "MIN" light is OFF.</p> 	<p>There is not enough product for operating in soaking mode (See § 0).</p>	<p>Add product Press the heating button.</p>
<p>The pump does not run. The red "MIN" light is OFF.</p> 	<p>The brush is clogged.</p>	<p>Remove the brush and clean the input opening.</p>
	<p>The pump rotor is jammed.</p>	<p>Dismantle the pump rotor. Check the shaft and clean its housing (See Appendix 4 for dismantling the pump)</p>
<p>The pump doesn't work The red light "MIN" is off. The heating does not work</p> 	<p>The security thermostat has been switched on.</p>	<p>When the temperature is under 40°, re-switch on the thermostat by pushing the little button through the little hole. (refer to §3)</p>

APPENDIX 2 : REMOVING THE ELECTRICS KIT

Tools required: No

ATTENTION

Do not drop the connector into the liquid in the tank.



- 1.** Slide the brush pipe into the tank from the sink.



- 2** Unplug the parts washer from electric power
Unscrew the 2 knurled buttons



- 3** Begin to bring out the electric kit .



- 4** Disconnect pump hose



- 5** Disconnect the power cable



- 6** Take out the kit while holding the electric cable and the hose.

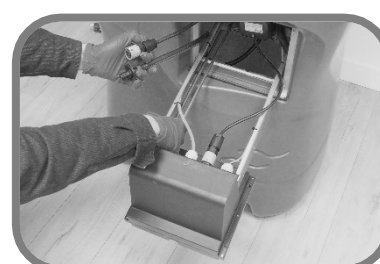

- 7** Remove the electric cable from the tank and the brush/brush hose.



ATTENTION

Do not drop the connector into the liquid in the tank.



APPENDIX 3 : DISMANTLING THE PUMP

Tools needed: no tools

<p>1 After disassembling the kit (Appendix 2), disconnect the electrical connector.</p> 	<p>4 Remove the part 3</p> 
 <p>Rotate the grey ring until the green dot is opposite the red dot.</p>	<p>5 Remove part 4</p> 
<p>2 Remove the pump from the slides.</p> 	<p>6 Remove the rotor assembly (by pulling on the blade).</p> 
<p>3 Remove the strainer</p> 	<p>7 Remove the white axis</p> <p> Beware the axis is fragile</p> 

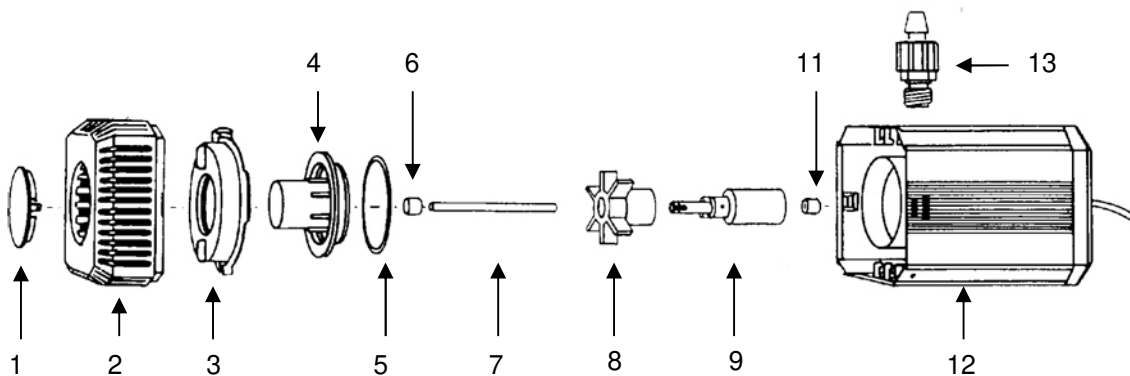

APPENDIX 4 : REASSEMBLY THE ELECTRIC KIT IN THE PARTS WASHER

Tools needed: no tools

1 Present the kit in front of the tank



2 Insert the kit in the tank, placing the hose and electric cable on top of the kit.

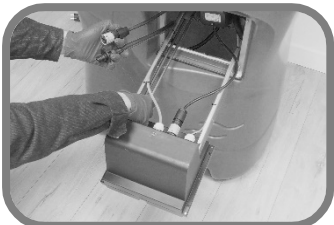

3 Connect the hose



4 Pull the hose from the sink hole



5 Connecting the electric cord :

- Position the connector so that its blue point is opposite the red point of the connector fixed on the box.
- Push the connector all the way in and turn it until the 2 blue dots are opposite each other.



6 Push the kit into the tank while slightly pulling the hose from the brush (make sure that the hose does not get stuck in the resistance)







7 Screw the kits back on with the 3 knurled buttons



APPENDIX 5 : PIECES DETACHEES

No	Photo	Reference	Designation
1		CSEQFOC065-001	SOAK TRAY PLATE
2		CSEQFO000349	SINK STOPPER
3		CSEQFO000289	STAINLESS STEEL BASKET FILTER
4		CSEQFO000125	SOCK FILTER
5		CSEQFO000111-3	BRUSH HANDLE (BLACK NOSE)
6		CSEQFO000103	QUICK LIQUID CONNECTOR
8a		CSEQFO000102-4	SCREWABLE BRUSH - Hard 5/10° Standard brush
8b		CSEQFO000102-3	SCREWABLE BRUSH -light 4/10e in option
19		CSEQFO000540	SAFETY THERMOSTAT - 58 °C THERMOSTAT DE SECURITE
20 A		CSEQFO000055-1-REV2	ELECTONIC KIT FS01. FS01 (FR) (Without pump and electric cord)
20 B		CSEQQFO000819	SUPPLY CABLE FOR FS01 KIT + Nitrile plate CSEQFO000173 + Passage cable FS01 CSEQFO000069
24A		CSEQFO000711	FS01 PUMP
22		CSEQFO000529	LEVEL SENSOR (+ 2 lugs)
23		CSEQFO000036	FS01 HEATER (530 mm) (Seal included and screw)
25		CSEQFO000345	PUMP AXIS

26		CSEQFO000187-1	AIR PUMP FS00
27		CSEQFO000282	AIR PUMP HOSE (70 ML)
28		CSEQFO000589	PUSH BUTTON <i>(incl. 3 pieces)</i>
29		CSEQFO000011	FUSES KIT FS00 ELECTRICAL FUSE E (250mA) x2 PUMP FUSE (4A) PROTECTION FUSE 12V (2A)

NOTES :



EuroGarden

www.eurogarden.com

YOUR CONTACT