

SINCE 1839

# BRINLY OWNER'S MANUAL

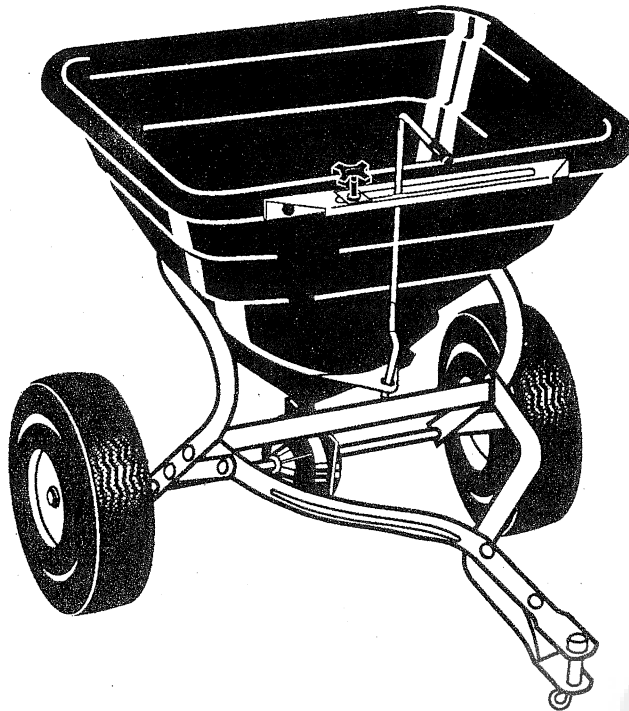

**BST-150 BH  
BROADCAST SPREADER  
MODEL - BST-1500 BH**

*Toll Free  
Customer  
Service  
# 877-728-8224*

**"IMPORTANT: THIS MANUAL CONTAINS INFORMATION FOR THE SAFETY OF PERSONS AND PROPERTY. READ IT CAREFULLY BEFORE ASSEMBLY AND OPERATION OF THE EQUIPMENT!"**

### LIMITED WARRANTY

Brinly-Hardy Company warrants only to the original retail purchaser that this product will remain free of defects in workmanship and materials under normal use and service for a period of two (2) years (NOTE: ninety (90) days for commercial or rental use) commencing with the date of purchase.

Any parts found to be defective within the warranty period will be replaced, with proof of date of purchase, at Brinly-Hardy Company's expense. Our obligation under this warranty is expressly limited to replacement or repair at our option of parts which are defective in material or workmanship within thirty (30) days of receipt of the parts. This warranty does not apply to damage caused by unreasonable use, including failure to provide necessary maintenance, nor does it apply to any transportation or labor charges.

WE MAKE NO OTHER EXPRESS WARRANTY NOR IS ANYONE AUTHORIZED TO MAKE ANY ON OUR BEHALF. ANY IMPLIED OR STATUTORY WARRANTIES, INCLUDING ANY WARRANTY OF MERCHANTABILITY OR FITNESS FOR A PARTICULAR PURPOSE, ARE LIMITED TO THE DURATION OF THIS WRITTEN WARRANTY. WE SHALL NOT BE LIABLE FOR CONSEQUENTIAL OR INCIDENTAL DAMAGES OF ANY KIND.

**MADE IN U.S.A.**

BRINLY-HARDY COMPANY 1-800-626-5329

# INTRODUCTION

Thank you for buying this quality product! Your Broadcast Spreader is equipped with a bevel gear drive system. It is recommended for use with all granular material (maximum granular size 3/16"), such as fertilizer, seed, sand, salt, ice melters, etc. This Spreader is NOT recommended for spreading powdered materials such as Hydrated Lime.

Please read and retain this manual. The instructions will enable you to assemble and maintain your implement properly. Always observe the "SAFETY RULES".

Should the need ever exist for repair parts, order through most any Lawn and Garden Dealer, using part number and description.

 **LOOK FOR THIS SYMBOL TO POINT OUT IMPORTANT SAFETY PRECAUTIONS. IT MEANS - ATTENTION! BECOME ALERT! YOUR SAFETY IS INVOLVED**



## RULES FOR SAFE OPERATION

- Know controls and how to stop quickly, **READ THE OWNER'S MANUAL.**
- Do not allow children to operate the vehicle. Do not allow adults to operate without proper instruction and without having read the owner's manual.
- Do not carry passengers. Keep children and pets a safe distance away.
- Always wear substantial footwear. Do not wear loose fitting clothing that can get caught in moving parts.
- Keep your eyes and mind on your tractor/attachment and area being covered. Don't let other interests distract you.
- Stay alert for holes in the terrain and other hidden hazards.
- Keep the vehicle and attachment in good operating condition and keep safety devices in place.
- Keep all nuts, bolts and screws tight to be sure the equipment is in safe working condition.
- The vehicle and attachment should be stopped and inspected for damage after striking a foreign object. The damage should be repaired before restarting and operating the equipment.
- See tractor equipment owner's manual for safe operation of the equipment.
- Do not drive close to creeks, ditches and public highways.
- Watch out for traffic when crossing or near roadways
- When using any attachment, don't allow anyone near the vehicle while in operation.



## WARNING

- Shutter plate may have sharp edges . Handle with caution. Work gloves are recommended to avoid injury.
- Lock nuts must be used where specified. They have a slightly oblong hole and are domed on one end.
- Do not load the hopper with more than the maximum weight capacity of 75 pounds.
- Only tow your spreader behind vehicles for which it was designed - riders, lawn/garden tractors, and ATVs.
- Always operate your spreader within the speed limit for which it was designed - 3 to 4 MPH.

## CUSTOMER RESPONSIBILITIES

- Read and observe the "SAFETY RULES"
- Follow a regular schedule in maintaining, caring for, and using your Attachment.

## TABLE OF CONTENTS

WARRANTY .....	1	OPERATION .....	7
SAFETY RULES .....	2	MAINTENANCE .....	7
HARDWARE .....	3	REPAIR PARTS .....	8
ASSEMBLY .....	4, 5 & 6		

# HARDWARE

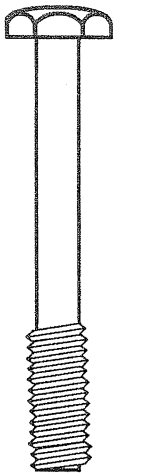

No. 29  
1M0840P  
1/4" x 2 1/2"  
Hex Bolt

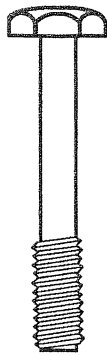

No. 25  
1M0828P  
1/4" x 1 3/4"  
Hex Bolt

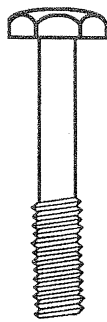

No. 24  
1M0824P  
1/4" x 1 1/2"  
Hex Bolt

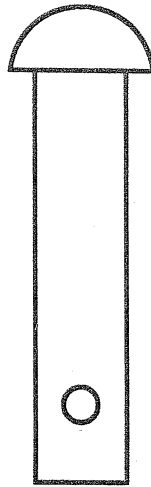

No. 31  
B-3861  
Drawbar Pin

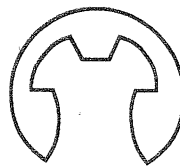

No. 12  
F-577  
"E" Type  
Snap Ring



No. 7  
45M0909P  
1/4" Flat  
Washer



No. 20  
45M1717P  
1/2" Flat Washer



No. 35  
B-3372 5/16" x 3/4" Vinyl Grip

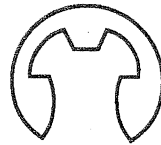

No. 23  
F-621 1/2" "E"  
Type Snap Ring



No. 28  
B-4785  
1/4" Nylon  
Insert Nut



No. 3  
B-1673P  
1/4" Hex  
Lock Nut



No. 2  
F-575 1/4"  
Thrust Washer

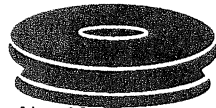

No. 16  
F-591 Fan Driver

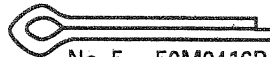

No. 5 50M0416P  
1/8" x 1" Cotter Pin



No. 1  
F-313 1/4"  
Gate "O" Ring



No. 8  
F-365 3/8"  
I.D. "O" Ring

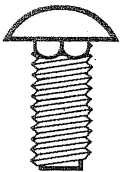

No. 37  
10M1012P  
5/16" x 3/4"  
Carriage Bolt

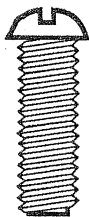

No. 33  
20M0816P  
1/4" x 1" Round  
Head Screw

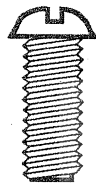

No. 13  
20M0812P  
1/4" x 3/4"  
Round Head  
Screw



No. 6  
F-395  
1/4" x 3/4"  
Hex Head  
Screw

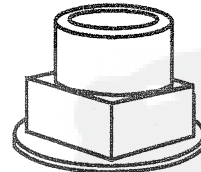

No. 19  
F-383 1/2" I.D.  
Axle Bearing



No. 9  
F-384 Fan Shaft  
Bearing w/Groove



No. 17  
F-595  
Lock Clip



No. 38 F-847  
Flow Control Spring

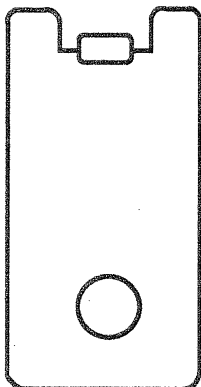

No. 39  
F-785 Gage Stop

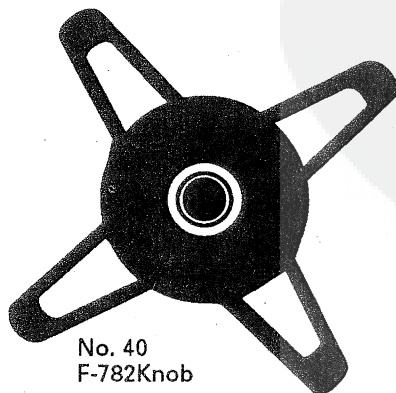

No. 40  
F-782 Knob

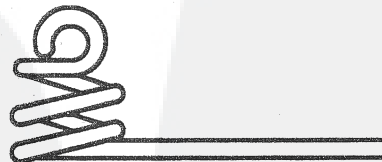

No. 4  
F-436 Torsion Spring Agitator

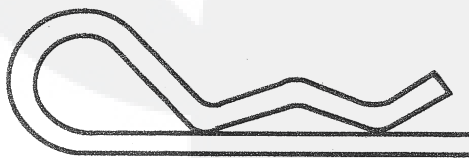

No. 32  
D-146P 1/8" Hairpin Cotter

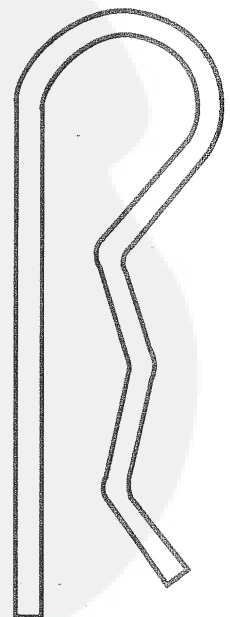

No. 21  
F-620 Hairpin Cotter



# ASSEMBLY

## TOOLS REQUIRED FOR ASSEMBLY:

- 1 - Pair of Pliers (Slip-joint recommended).
- 1 - Screwdriver (Flat).
- 2 - 7/16" Wrenches.
- 1 - Pair of Work Gloves.

### Refer to FIG 1.

- Turn the hopper upside down and insert the grooved fan shaft bearing through the square hole in the bottom of hopper from INSIDE the hopper.
- Place the shutter plate on the hopper base (with the triangular openings aligned) and the bearing (grooved end) protruding through the matching round hole in the shutter plate.
- Secure the assembly by sliding the "E" ring into the groove with a pair of pliers.

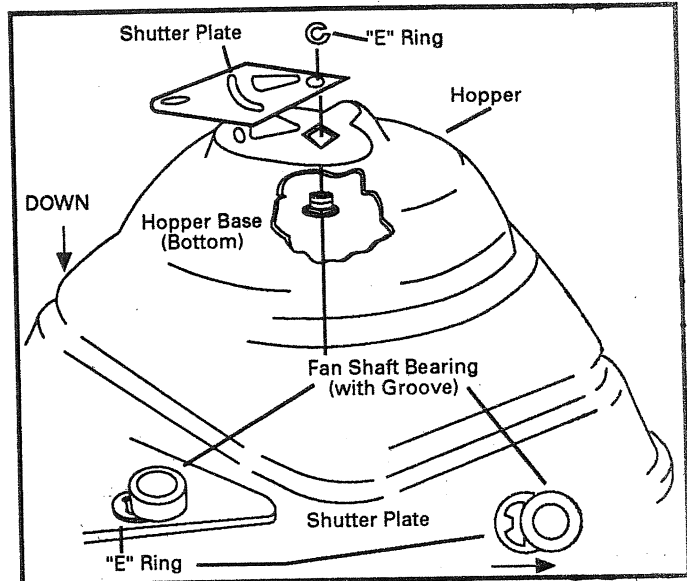

FIG 1.

### Refer to FIG. 2.

- With the hopper still upside down, insert one 1/4" x 3/4" round head screw through one 1/4" nylon thrust washer and then the curved slot in shutter plate and corresponding round hole in hopper base.
- Complete this assembly by slipping the 1/4" gate "O" ring and remaining 1/4" nylon thrust washer onto the round head screw.
- Secure with one 1/4" hex lock nut. Must have domed head. NOTE: Do not tighten the shutter to the point of binding; there should be a "slight" amount of friction between the shutter and the hopper body.

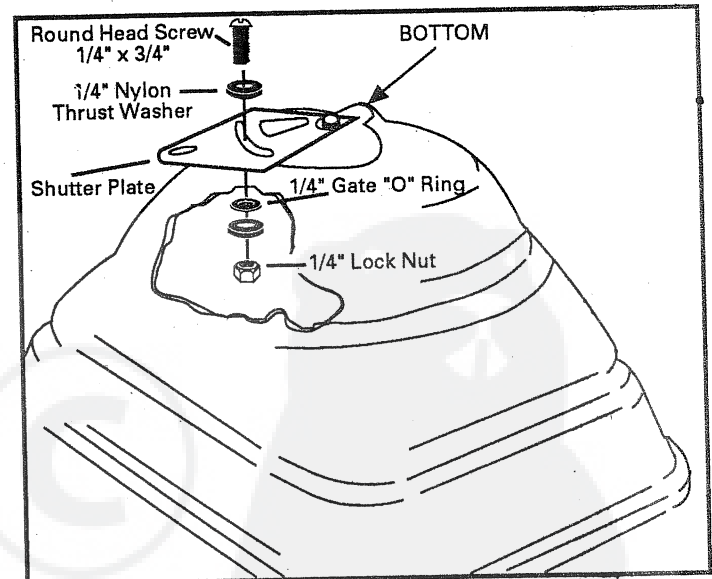

FIG. 2.

### Refer to FIG. 3.

- Inspect the gearbox assembly and note the following: The fan shaft extends from the center of the gear housings at the gearbox cap and is smaller in diameter than the axle which extends from the end of each gearbox housing half.
- Slide the lock clip down the fan shaft with a pair of pliers, then slide the fan driver (WITH THE LARGE DIAMETER FLANGE FACING UP) down the shaft and follow with fan.

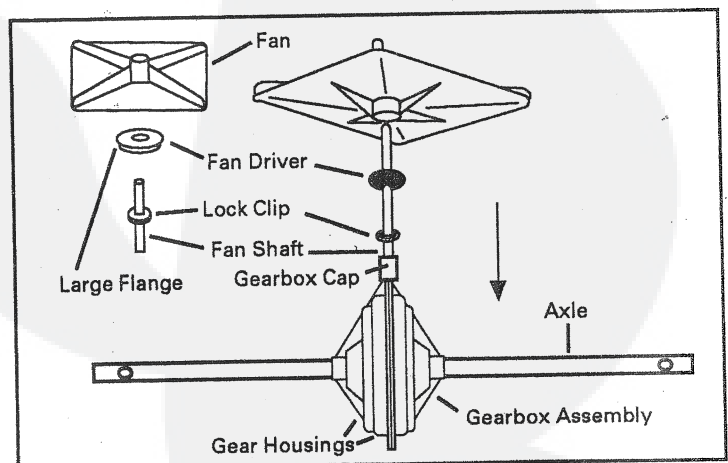

FIG 3.

### Refer to FIG. 4.

**NOTE:** The Shutter Plate protrudes from the **FRONT** of the hopper.

- While looking at the **REAR** of the hopper (while it is still upside down), insert the fan shaft of the gearbox assembly into the fan shaft bearing in hopper.
- Slip one end of the hopper support (each end has a square hole) onto one end of axle, then slip the other end of the hopper support onto the other axle end and sit the hopper support on the **REAR** of hopper. (Positioned at the five mounting holes in hopper).
- The rotation of the fan must now be determined. Grasp the axle and rotate it toward you and observe the direction that the fan is rotating - it **MUST** turn **CLOCKWISE**.

**NOTE:** Should the fan be found to rotate **COUNTER-CLOCKWISE**, remove the hopper support, rotate the gearbox assembly to your right - **CLOCKWISE**, 1/2 a complete rotation and relocate the hopper support and again check the fan rotation to be sure it is now rotating **Clockwise**.

- Secure the hopper support to the hopper with five hex head screws and five 1/4" flat washers - installed from inside the hopper. Tighten these screws securely.
- Place the axle bearings (WITH FLANGES FACING OUTWARD) on the ends of the axle and insert the bearings into the square holes in the ends of the hopper support.
- Adjust the fan assembly by slipping the components down toward the fan shaft bearing until the fan almost touches the bearing. Be sure the fan driver is pushed down between the ribs on the bottom of the fan and that the lock clip is against the driver.

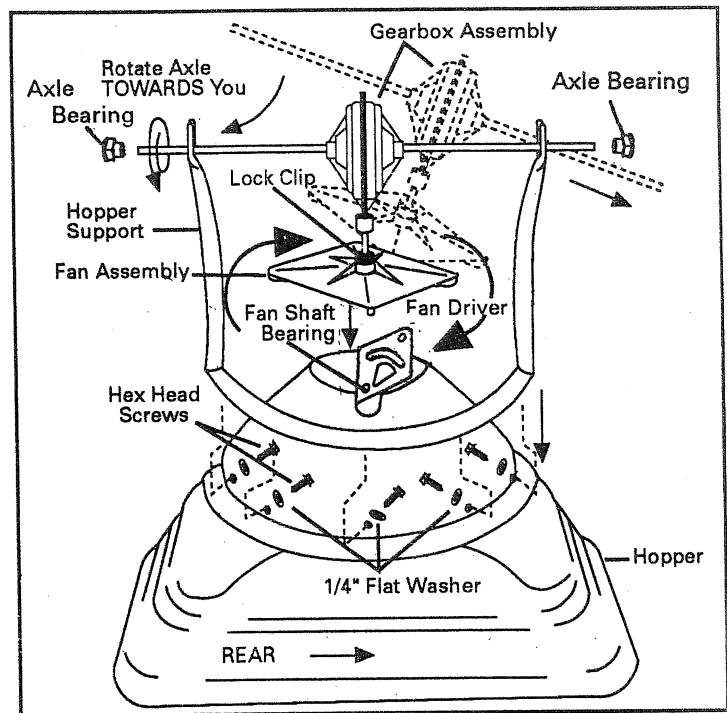

FIG. 4.

### Refer to FIG. 5.

- Slide a 1/2" flat washer on each end of the axle followed by a wheel and then another 1/2" flat washer.
- Secure each axle end by installing a 1/2" "E" ring into the groove located at each end of the axle.
- Rotate either wheel until the hole in the hub lines up with the matching hole in the axle and then insert one hairpin cotter as shown.

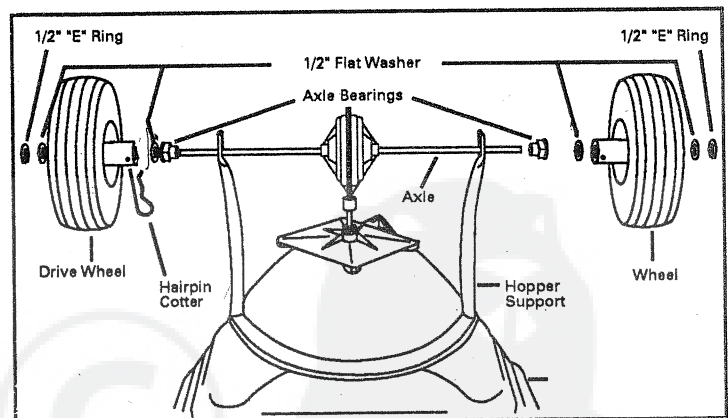

FIG 5.

### Refer to FIG. 6.

- Turn the spreader right side up (on its wheels) and slip the 3/8" "O" ring onto the fan shaft.
- Install the spring agitator with the long leg on the bottom and the small loop at the top - on the fan shaft.
- Align the hole in the shaft with the spring's loop and then insert one 1/8" x 1" cotter pin (from the loop side) through the assembly and bend the legs over with pliers.

**NOTE:** Again check the direction of rotation. While viewing the inside of hopper from above, the agitator **MUST** rotate **COUNTER-CLOCKWISE**, when pulling the unit forward. If the agitator rotates clockwise, repeat the steps described in FIGURE 4.

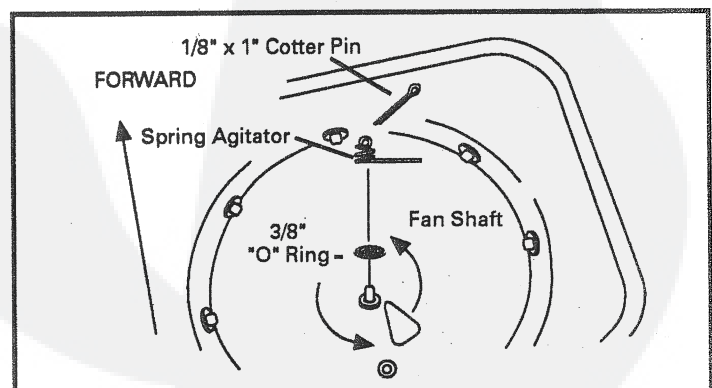

FIG 6.

Refer to FIG. 7.

- Attach gage plate to three holes in top lip at front of hopper using three 1/4" x 3/4" round head screws, flat washers (next to slots in gage plate) and nylon insert nuts (inside hopper). Do NOT tighten at this time.
- Slide formed end of shutter handle through long slot in gage plate; position opposite end of shutter handle into hole in previously assembled shutter plate at bottom of hopper.
- Match the hole in center of shutter handle with hole in hopper. Attach using 1/4" x 1" round head screw (with 1/4" flat washer next to head) from inside of hopper, 1/4" flat washer at both sides of shutter handle and securing with a 1/4" hex lock nut (has domed head). Tighten snugly to allow pivoting without binding.
- Place the 5/16" vinyl grip over the shutter handle.

GAGE PLATE CALIBRATION

- Close the shutter completely by moving the handle all the way to the right.
- Position gage plate so shutter handle aligns with "O" on calibration plate. Tighten three retaining screws securely.
- Install the gage stop onto gage plate - formed tab towards handle and inside the slot.
- Secure with 5/16" x 3/4" carriage bolt, flow control spring (under carriage bolt head) as shown in Fig. 7-Illustration "A". Insert from under gage plate, up through gage stop, securing with plastic knob. Slide to the left and tighten.

NOTE: Flow control spring holds shutter handle in place.

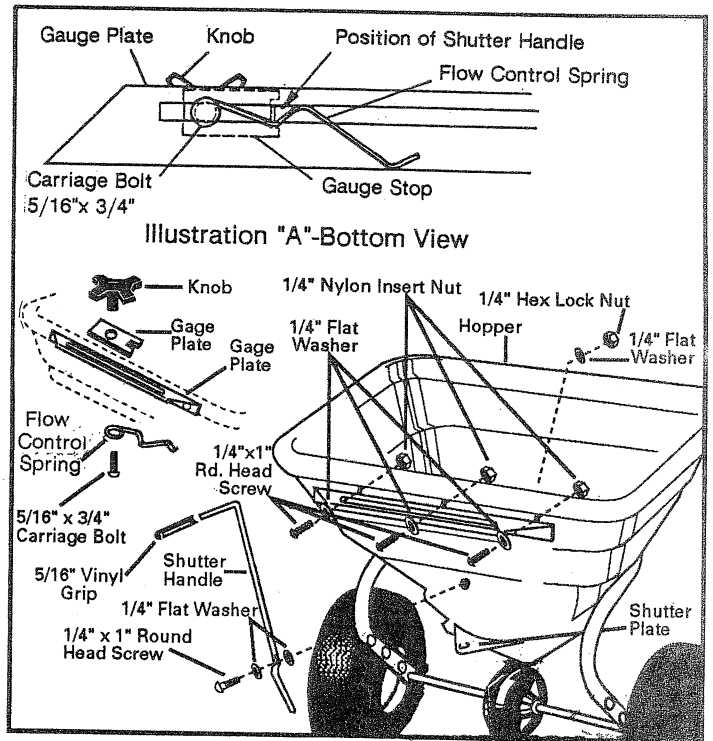

FIG. 7.

Refer to FIG. 8

- Assemble cross bar and two tow tubes to upper holes at inside of hopper support - (short ends of tow tubes assemble to hopper support) using two 1/4" x 1 3/4" hex bolts (from outside of frame) and 1/4" nylon insert nuts. Do NOT tighten at this time.
- Join tow tubes on top of one another at front (join tubes to form clevis - see insert). Secure with two 1/4" x 2-1/2" hex bolts (through smaller holes in tubes) and 1/4" nylon insert nuts. Do NOT tighten at this time.
- Attach the braces (with offsets INWARD) to forward holes at each side tow tube and to middle holes in legs of hopper support using four 1/4" x 1-1/2" hex bolts and 1/4" nylon insert nuts.

IMPORTANT: Refer to Figures 5 & 8

- Rotate the "drive wheel", checking the amount of resistance in the gear and fan system. If there is any excessive side movement, realign the gearbox by adding additional 1/2" flat washers behind the wheels.
- Insert drawbar pin through front holes in tow tubes and secure with hairpin cotter.
- Tighten all tow tubes mounting bolts securely, careful not to overtighten and collapse tubes.
- If Logo Decal is not applied to rear of Hopper, see parts page for location, and apply.

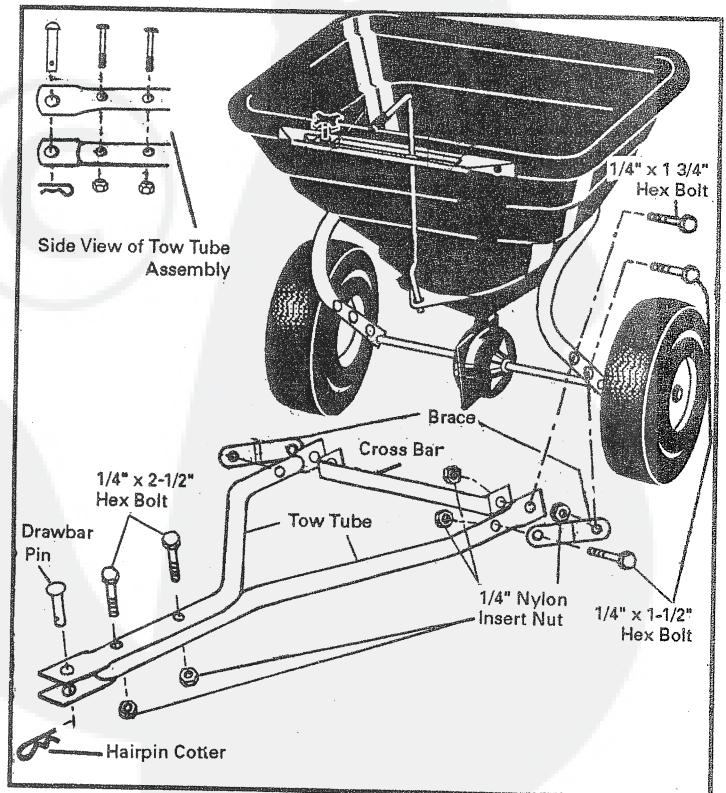

FIG 8.



# CARING FOR THE QUALITY OF YOUR LAWN

with quality products from  
**BRINLY-HARDY COMPANY, JEFFERSONVILLE, IN**

## Our Quality Products

### Spike Aerators

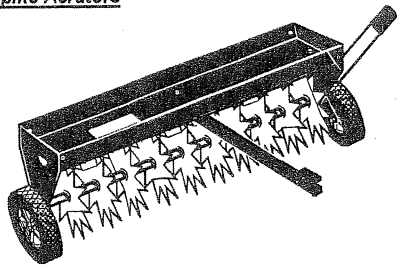

Our Spiker Aerators allow seed, fertilizer, air, and water to reach the lawn's root system, where they do the most good. This means fewer chemical applications and less frequent watering.

### Plug Aerators

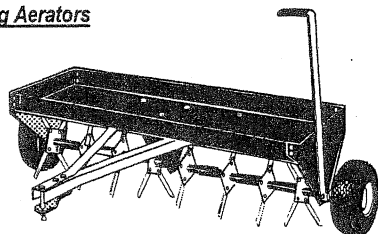

Our Plug-type Aerators are designed for the lawn care enthusiast who demands the ultimate in turf aeration! It actually pulls "plugs" of soil to relieve soil compaction and deposits them on top of the lawn where they're quickly broken down. You, too, can have a healthy looking lawn, once only affordable to golf courses!

#### TO ORDER PARTS:

Brinly-Hardy Company  
P.O. Box 18  
Jeffersonville, IN 47131-0018  
800-626-5329

### Aerator Spreaders

You can actually handle two jobs at once with our Aerator-Spreader! This natural combination allows the 30" Aerator to perforate the soil, and the spreader immediately follows with seed, lime, or fertilizer; putting it INTO the ground so it can't be washed away!

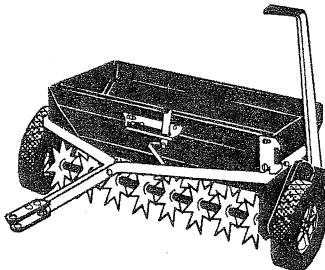

### Broadcast Spreaders

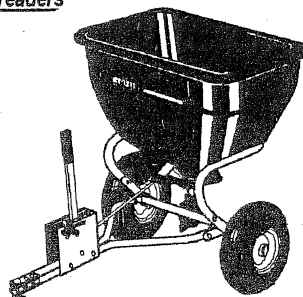

Our Brinly Spreaders handle everything from seed to ice-melters. Equipped with AutoFlow™, the material flow stops and starts when the rider does...no need to worry about "burns" or "streaks" on the lawn. Our gears are fully enclosed, so they'll last and last!

Our larger 2.5 and 3.5 cu. ft. Spreaders offer a unique, Directional Spread Pattern Control that lets you CHOOSE your spread pattern; adjust it to spread to either side or to center. Also, a clear, vinyl cover is included to protect materials from moisture.

## About the Company

For generations, Brinly-Hardy has been serving the growing needs of farmers, gardeners, lawn professionals, and homeowners. Our first plow was introduced in 1839, and ever since, we have been forging a name in the production of quality-crafted farm, lawn, turf, and garden tools. It's a proud heritage, one you can trust in caring for your lawn.

### Dethatchers

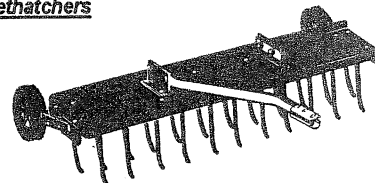

If left alone, matted layers of thatch and large grass clippings can form on your lawn which prevents air circulation and breeds disease. Our patented design Dethatcher with spring steel tines gently comb thatch and clippings to the surface where they can be re-mulched, collected, or left exposed to the elements to break down.

### Utility Carts

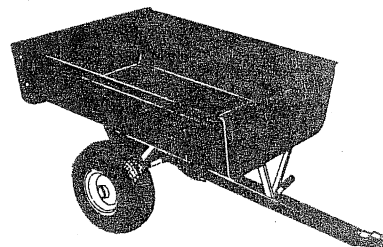

Our Dumping Utility Carts have a patented, rounded corner design which prevents soil, gravel, mulch, sand, etc. from getting trapped along the edges (where they can cause rust), and the bracketless, removable tailgate has NO obstructions to catch material when dumping. These Utility Carts are built to last with our solid steel axles, heavy steel beds, and our state-of-the-art powder coated paint finish.

CUT HERE

**BRINLY-HARDY COMPANY**  
**P.O. BOX 18**  
**JEFFERSONVILLE, IN 47131-0018**

### Sweepers

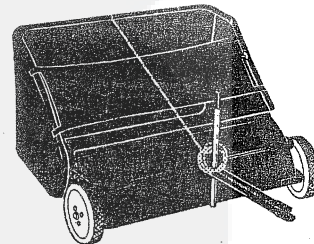

A Brinly-Hardy Sweeper is sure to make your outside chores much easier! Forget the brooms and rakes, you can quickly sweep up grass clippings, leaves, and even debris from the pavement and quickly dump them into compost bins or bags. The spring-loaded Compost Clip makes it a snap!

For even more versatility, attach our new Dethatcher Kit to either our 30" or 36" Sweeper, and tackle two jobs at once!

These sweepers are built for all seasons and will last for years and years.

Sprayers

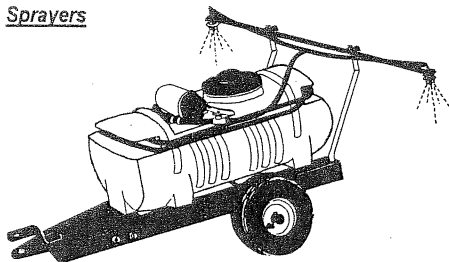

Brinly sprayers are designed to be easy to use, extremely accurate, and long lasting. Our in-line mounted tank design means that even the biggest tank is easy to maneuver and can fit through a garden gate. Each unit comes with a tractor-mounted on/off control.

Poly Lawn Rollers

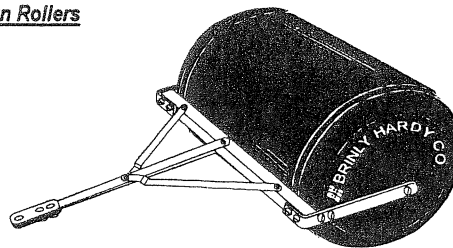

No more rust or dents with these poly lawn rollers. These units are much easier to deal with than the steel versions. They have rounded end caps that won't tear or gouge the lawn when turning. Erase the harmful effects of front heaving and moles, or pack down newly sown seed or sod.

Garden Tractor Attachments

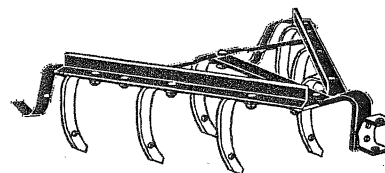
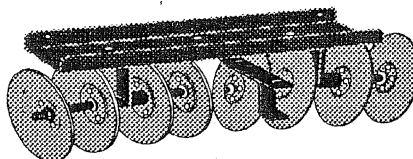
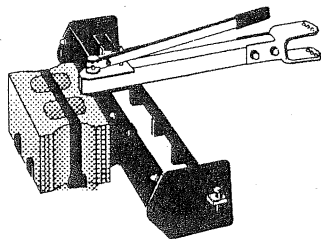

Brinly's garden tractor items offer the largest selection to turn your garden tractor into a year-round tool. We have box scrapers, blades, cultivators, disk harrows, and even a plow! Remember that a sleeve hitch is required to hook up these items to your garden tractor.

**Quality Insurance**

Dear Customer,

We are very proud of our quality and endeavor to produce each product to meet high standards. Should your purchase not meet your expectations, we have a Quality Insurance Policy.

If you purchase a product and a part is missing or defective, please inform us of the problem on the "Comments" section of the Warranty Registration Card below. Mail the card to us, or you may call us toll free at 1-800-626-5329. We will make every effort to ship a new replacement part to you within 24 hours at no charge.

Thank you,

President  
Brinly-Hardy Company

**WARRANTY REGISTRATION CARD**

To register your new product for warranty, please complete and return this card.

Name: \_\_\_\_\_ Phone: \_\_\_\_\_

Address: \_\_\_\_\_

City: \_\_\_\_\_ State: \_\_\_\_\_ Zip: \_\_\_\_\_ Country: \_\_\_\_\_

Product Purchased: \_\_\_\_\_ Model No.: \_\_\_\_\_

Packing No. (On Carton): \_\_\_\_\_

Where Purchased: \_\_\_\_\_ Date Purchased: \_\_\_\_\_

Type of Tractor/Rider Owned? Make: \_\_\_\_\_ Model: \_\_\_\_\_ HP: \_\_\_\_\_

Size of Lawn?  1/4 to 1/2 acre  1/2 to 1 acre  1 to 5 acres  over 5 acres

Do you garden?  Yes  No  Use a tractor?  Use a tiller?

Your occupation: \_\_\_\_\_

**YOUR COMMENTS WILL BE APPRECIATED:** \_\_\_\_\_

\_\_\_\_\_  
\_\_\_\_\_  
\_\_\_\_\_  
\_\_\_\_\_

**Warranty Registration Card**

Please complete the Warranty Registration Card, place in an envelope and mail to us so that we will have a record of your purchase and your comments.



BRINLY HARDY COMPANY  
P.O. BOX 18  
JEFFERSONVILLE, IN.  
47131-0018



## OPERATION

- The fan speed and the spread width are controlled by the speed at which you operate the spreader. The recommended operating speed is slightly faster than that of a brisk walk, 3 to 4 MPH.
- The control lever operates the flow control shutter. The flow control decal (Fig. 7) is marked OFF to 10. The position selected determines the amount of material to be broadcast. The higher the number, the heavier the application of material.

NOTE: Close shutter before filling hopper. Keep the plastic knob (Fig. 7) and gage stop tight at all times.



### CAUTION

• Do not load the hopper with more than the maximum weight capacity of 75 pounds.

- Determine the flow control number setting required for your job using the Application Rate Chart. After determining the correct setting number for your material, set shutter handle (adjust shutter) to that position. This is done by loosening the plastic knob and moving the gage stop, then re-tightening nut.

## OPERATING TIPS

- When spreading ice melters, use 2 hairpin cotters - 1 in each wheel hub, for better traction.
- When spreading seed, fertilizer, etc., insert only 1 hairpin cotter in either the right or left wheel hub.
- Do not fill hopper and transport over long distances. This may result in packing, causing poor or erratic discharge. Fill only at operation site.
- Break up any lumps as you fill the hopper.
- Do not use on windy days, especially when spreading fine grass seed or herbicides.
- For best results, select a LOWER (smaller number) shutter setting and spread material using TWO light applications - use a "criss-cross" or overlap pattern on the second application.

## MAINTENANCE

- To ensure years of trouble-free service, clean the spreader thoroughly with water after each use.
- For rust on frame parts, sand lightly and paint with enamel.
- Periodically lubricate all bearing surfaces.

## APPLICATION RATE CHART

Fertilizer application rates (as shown on the chart) are affected by humidity and the moisture content of the material (granular and pellet). Therefore, minor setting adjustments may be necessary to compensate for these conditions.

Material Type	Average Recommended Usage	Push Speed	Shutter Setting	Spread Width
<b>SEED</b>				
KY BLUEGRASS	2 lb./1,000 sq. ft.	3 MPH	7 1/2	5 ft.
RYE	4 lb./1,000 sq. ft.	3 MPH	10	8 1/2 ft.
TALL LAWN FESCUE	6 lb./1,000 ft.	3 MPH	10	10 ft.
<b>FERTILIZER</b>				
10-10-10	50 lb./5,000 sq. ft.	3 MPH	9 1/2	16 ft.
10-20-10 WONDER GRO	40 lb./10,000 sq. ft.	3 MPH	9 1/2	16 ft.
10-18-10 GREEN VIEW WINTER GREEN 2 WAY	20 lb./5,000 sq. ft.	3 MPH	5	9 ft.
18-24-6 SCOTT'S STARTER FERTILIZER	20 lb./3,000 sq. ft. 20 lb./5,000 sq. ft.	3 MPH 3 MPH	7 5 1/2	6 ft. 6 ft.
SCOTT'S TURF BUILDER	13 1/4 lb. /5,000 sq. ft.	3 MPH	4 1/2	6 ft.
<b>LAWN WEED AND INSECT CONTROL</b>				
WONDER-GRO LAWN WEED KILLER	8 lb./5,000 sq. ft.	3 MPH	6	4 ft.
SCOTT'S LAWN INSECT CONTROL	12 1/2 lb. /5,000 sq. ft.	3 MPH	4 1/2	6 ft.

# BST-1500 BH

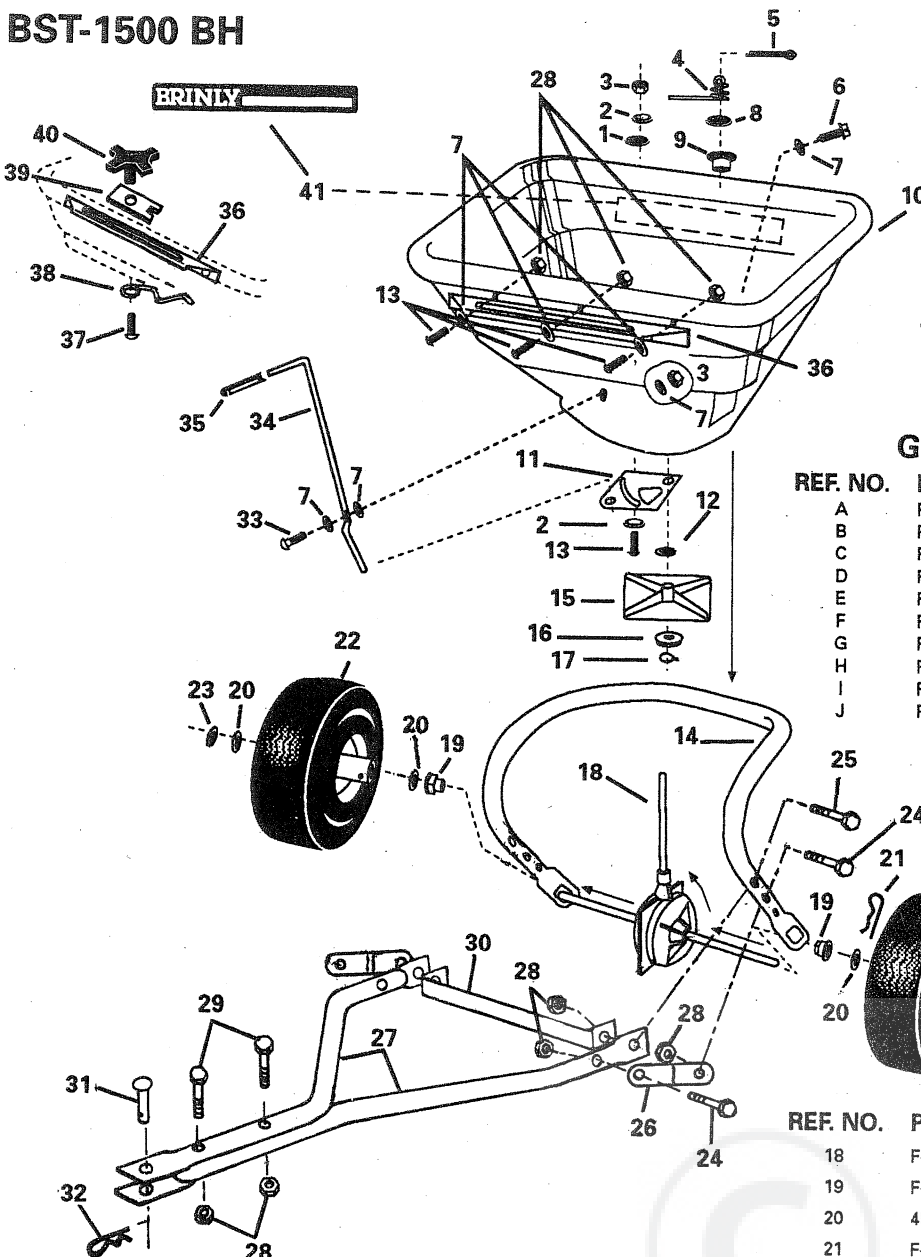

## TO ORDER PARTS:

BRINLY HARDY COMPANY  
P.O. BOX 18  
JEFFERSONVILLE, IN.  
47131-0018

## GEARBOX/AXLE ASSEMBY

REF. NO.	PART NO.	DESCRIPTION	QUANTITY
A	F-378	Pinion	1
B	F-379	Gear	1
C	F-380	Pinion Carrier	1
D	F-381-G	Housing Half (Gearbox)	2
E	F-394	Fan Shaft	1
F	F-398	Gearbox Cap	1
G	F-413	Spiral Pin, 5/32" x 1'	1
H	F-414	Spiral Pin, 1/8" x 3/4"	1
I	F-415	Hex Washer Head Screw	4
J	F-613-01	Axle	1

REF. NO.	PART NO.	DESCRIPTION	QUANTITY
18	F-612	Gearbox & Axle Assembly	1
19	F-383	Axle Bearing, 1/2"	2
20	45M1717P	Flat Washer, 1/2"	7
21	F-620	Hairpin Cotter (large)	2
22	F-615	Wheel	2
23	F-621	"E" Ring - Axle 1/2" (small)	2
24	1M0824P	Hex Bolt, 1/4" x 1 1/2"	4
25	1M0828P	Hex Bolt, 1/4" x 1 3/4"	2
26	F-777-10	Brace	2
27	F-776-10	Tow Tube	2
28	B-4785	Nylon Insert Nut, 1/4"	11
29	1M0840P	Hex Bolt, 1/4" x 2 1/2"	2
30	F-786-10	Cross Bar	1
31	B-3861	Hitch Pin	1
32	D-146P	Hair Pin Cotter	1
33	20M0816P	Round Head Screw, 1/4" X 1"	1
34	F-774	Shutter Handle	1
35	B-3372	Vinyl Grip	1
36	F-771	Gage Plate	1
37	10M1012P	Carriage Bolt, 5/16" x 3/4"	1
38	F-847	Flow Control Spring	1
39	F-785	Gage Stop	1
40	F-782	Knob	1
41	B-59 22	Logo Decal	1
42	L-1547-1 BH	Instructions	1

## PARTS LIST

REF. NO.	PART NO.	DESCRIPTION	QUANTITY
1	F313	Gate "O" Ring	1
2	F575	Nylon Thrust Washer	2
3	B1673P	Hex Lock Nut (Domed) - 1/4"	2
4	F-436	Torsion Spring Agitator	1
5	50M0416P	Cotter Pin, 1/8" D. x 1	1
6	F-395	Hex Head Screw, 1/4" x 3/4"	5
7	45M0909P	Flat Washer, 1/4"	11
8	F-365	"O" Ring, 3/8" (Fan Shaft)	1
9	F-384	Fan Shaft Bearing, 3/8"	1
10	F-691A-1	Hopper	1
11	F-689	Shutter Plate	1
12	F-577	"E" Ring-Fan Bearing 5/8" (large)	1
13	20M0812P	Round Head Screw, 1/4" x 3/4"	4
14	F-775-10	Hopper Support	1
15	F-573	Fan	1
16	F-591	Fan Driver	1
17	F-595	Lock Clip	1