



SHINDAIWA OWNER'S/OPERATOR'S MANUAL

AH230 ARTICULATED HEDGE TRIMMER



WARNING!

Minimize the risk of injury to yourself and others!
Read this manual and familiarize yourself with the contents.
Always wear eye and hearing protection when operating this unit.
This machine is designed for trimming hedge.
Do not use this machine for other purposes.
Do not operate or service this machine unless you clearly understand this manual.
Keep this manual available at all times so that it may be referred to if questions arise regarding this unit's use.

shindaiwa

Part Number 62849-94310
Rev. 12/04

Introduction

The Shindaiwa AH230 Articulated Hedge Trimmer is designed and built to deliver superior performance and reliability without compromise to quality, comfort, safety or durability. Shindaiwa's high-performance engines represent the leading edge of 2-cycle engine technology, delivering exceptionally high power with remarkably low displacement and weight. As an owner/operator, you'll soon discover for yourself why Shindaiwa is simply in a class by itself!

The procedures described in this manual are intended to help you get the most from your machine as well as to protect you and others from harm. These procedures are guidelines for safe operation under most conditions, and are not intended to replace any safety rules and/or laws that may be in force in your area.

If you have questions regarding your power tool, or if you do not understand something in this manual, your Shindaiwa dealer will be glad to assist you.

IMPORTANT!

The information contained in these instructions describes units available at the time of publication. While every attempt has been made to provide the latest information about your Shindaiwa product, there may be some differences between your AH230 and what is described here. Shindaiwa Inc. reserves the right to make changes to products without prior notice and without obligation to make alterations to units previously manufactured.

Contents

	PAGE
Attention Statements	2
Safety Precautions.....	3
Operating Precautions.....	4
Technical Specifications.....	6
Unit Description	6
Powerhead Installation	7
Throttle and Cutter Adjustments	8
Starting the Engine.....	10
Stopping The Engine	11
Adjusting The Carburetor	11
Attaching The Shoulder Strap	12
Using The Hedge Trimmer	12
General Maintenance	13
Long Term Storage	15
Troubleshooting.....	16
Declaration of Conformity.....	19

Attention Statements

Throughout this manual are special "attention statements" surrounded by boxes and preceded by the triangular Attention Symbol.



DANGER!

A statement preceded by the triangular attention symbol and the word "DANGER" contains information that should be acted upon to prevent serious injury or death.



WARNING!

A statement preceded by the triangular attention symbol and the word "WARNING" contains information that should be acted upon to prevent serious bodily injury.

CAUTION!

A statement preceded by the word "CAUTION" contains information that should be acted upon to prevent mechanical damage.

IMPORTANT!

A statement preceded by the word "IMPORTANT" is one that possesses special significance.

NOTE:

A statement preceded by the word "NOTE" contains information that is handy to know and may make your job easier.

Safety Precautions



DANGER!



THE ARTICULATED HEDGE TRIMMER IS NOT INSULATED AGAINST ELECTRICAL SHOCK!

Approaching or contacting electrical line with the pruner could cause death or serious injury. Keep the pruner at least 10 meters away from electrical lines or branches that contact electrical lines.

An articulated hedge trimmer has the potential to do serious damage if misused, abused or mishandled. To reduce the risk of injury, you must maintain control at all times, and observe all safety precautions during operation. **Never permit a person without training or instruction to operate this trimmer!**

IMPORTANT!

The operational procedures described in this manual are intended to help you get the most from this unit and also to protect you and others from harm. These procedures are general guidelines only, and are not intended to replace any safety rules/laws that may be in force in your area.

If you have any questions regarding your AH230 Articulated Hedge Trimmer, or if you do not understand something in this manual, your Shindaiwa Dealer will be glad to assist you. For additional information, you may also contact Shindaiwa Inc. at the address printed on the back of this manual.



WARNING!

Do not make unauthorized modifications to this machine.

Warning Labels

Warning labels affixed to the machine are as follows:



Read and follow this manual, make sure anyone using this unit does likewise. Failure to do so could result in serious personal injury or machine failure. Keep this manual for future reference.



Always wear a hard hat to reduce the risk of head injuries during operation of this machine. In addition, always wear eye and hearing protection. Shindaiwa recommends wearing a face shield as additional face and eye protection.



Wear nonslip heavy-duty work gloves to improve your grip on this unit. Wear sturdy footwear with nonslip soles to provide good footing. Steel-toe safety boots are recommended. Wear snug-fitting clothes that also permit freedom of movement.



Never operate this tool or any other power equipment if you are tired, ill, or under the influence of alcohol, drugs, or any substance that could affect your ability or judgement.



Keep bystanders at least 15 meters away from the operating trimmer to reduce the risk of being struck by falling objects or thrown debris.



Be aware of the danger of falling debris.



Sound Power Level (measured in accordance with 2000/14/EC)

Safety Labels

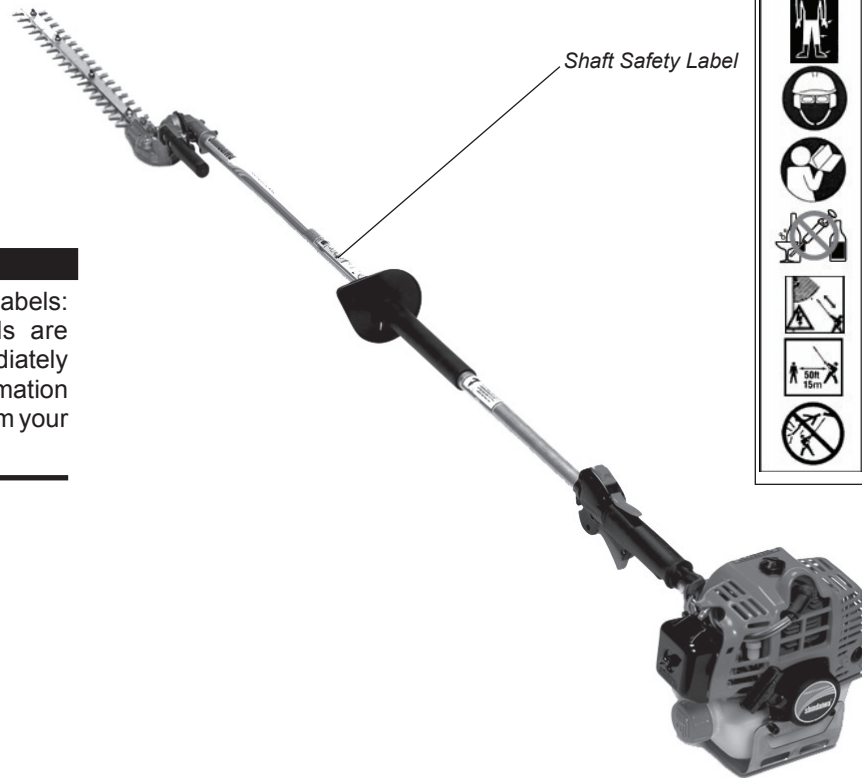

IMPORTANT!

Safety and Operation Information Labels: Make sure all information labels are undamaged and readable. Immediately replace damaged or missing information labels. New labels are available from your local authorized Shindaiwa dealer.

Operating Precautions



WARNING!

- Always make sure the cutter attachment is properly installed and firmly tightened before operation.
- Never use a cracked or warped cutter or cutter bar: replace it with a serviceable part and make sure it fits properly.
- Before starting the engine, make sure the cutter is not contacting anything.
- Always stop the engine immediately and check for damage if you strike a foreign object or if the unit becomes tangled. Do not operate with broken or damaged equipment.
- When cutting a branch that is under tension, be alert for spring-back so that you will not be struck by the moving branch.
- Stop the unit immediately if it suddenly begins to vibrate or shake. Inspect for broken, missing or improperly installed parts or attachments.
- Do not operate the articulated hedge trimmer with the muffler removed.
- Make sure there is always good ventilation when operating the articulated hedge trimmer. Fumes from engine exhaust can cause serious injury or death. **Never run the engine indoors!**
- Make sure there are no missing or loose fasteners, and that the stop switch and throttle controls are working properly.
- If a cutter should bind fast in a cut, shut off the engine immediately. Push the branch or tree to ease the bind and free the cutter.
- Make sure the cutters are correctly adjusted before operating the articulated hedge trimmer (see page 9 for cutter adjustment procedures). Never attempt cutter adjustment with the engine running!
- Always ensure all handles and guards are attached and secure when using the machine.

Operating Precautions

(Continued)



WARNING!

- Never transport the articulated hedge trimmer nor set it down with the engine running. An engine that's running could be accidentally accelerated causing the blades to oscillate.
- Make sure the cover is in place when transporting the articulated hedge trimmer.
- When carrying the articulated hedge trimmer by hand, the cutter attachment should be pointing backward with the cutter blade in the retracted or transporting position (see page 9 for articulating adjustment procedures).



CAUTION!

- Always maintain the articulated hedge trimmer according to the this owner's manual and follow the recommended scheduled maintenance.
- Never modify or disable any of the hedge trimmer's safety devices.
- Always use genuine Shindaiwa parts and accessories when repairing or maintaining this unit.
- Do not make unauthorized modifications or substitutions to the articulated hedge trimmer.
- Never allow the engine to run at high RPM without a load. Doing so could damage the engine.
- When transporting the hedge trimmer in a vehicle, tie it down securely to prevent damage and fuel spillage.
- Always clear your work area of trash or hidden debris to help ensure good footing.
- Keep the cutters sharp and properly adjusted.
- Keep the articulated hedge trimmer as clean as possible. Keep it free of loose vegetation, mud, etc.

Operating the Articulated Hedge trimmer

Always wear a hard hat to reduce the risk of head injuries during operation of this unit.

Secure long hair so it is above shoulder level.

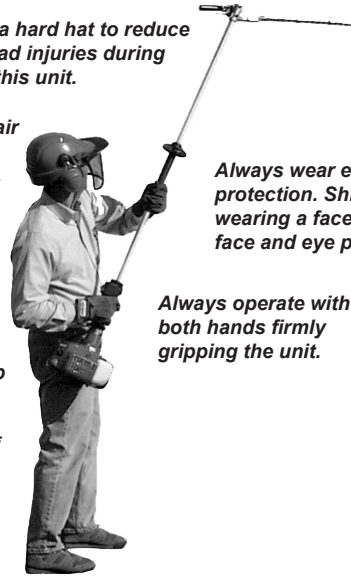

Always wear eye and hearing protection. Shindaiwa recommends wearing a face shield as additional face and eye protection.

Always operate with both hands firmly gripping the unit.

Wear non-slip heavy-duty gloves to improve your grip on the trimmer handle. Wear snug-fitting clothes that also permit freedom of movement. NEVER wear shorts!

Keep a proper footing and do not overreach—maintain your balance at all times during operation.



Keep bystanders at least 15 meters away from the operating trimmer to reduce the risk of being struck by falling objects or thrown debris.

Wear sturdy footwear with nonslip soles to provide good footing. Steel-toed safety boots are recommended.

Always be aware of your surroundings and stay alert for possible hazards that you may not hear due to noise from the machine.

Never allow children to use the machine. Avoid operating near bystanders.

Technical Specifications

Model Name	AH230/EC1
Engine Model	S230EC1
Engine Type	2-cycle, vertical cylinder, air cooled
Displacement.....	22.5 cm ³
Bore & Stroke	32 x 28 mm
Maximum Power Output.....	0.8 kW
Engine Speed at Idling	2,750 min ⁻¹
Maximum Engine Speed.....	10,000 min ⁻¹
Engine Speed at Maximum Power Output.....	7,500 min ⁻¹
Dry Weight	5.9 kg
Length (storage or transporting position)	2,350 mm
Blade Length	567 mm
Fuel Tank Capacity	550 cm ³
Fuel/Oil Ratio.....	50:1
Carburetor Type	Walbro WYL
Ignition System	1 Piece electronic, transistor controlled
Spark Plug.....	NGK BMR6A
Air Cleaner Type	Non-reversible flocked filter
Starting Method.....	Recoil starter
Stopping Method.....	Slide Switch
Sound pressure Level *	(Idling) 76 dB (A) (Racing) 94 dB (A)
Sound Power Level **	(Idling) 86 dB (A) (Racing) 106 dB (A)
Vibration Level ***	(Idling [Front/rear]) 2.9/2.9 m/s ² (Racing [Front/Rear]) 7.0/5.3 m/s ²

* Sound Pressure Level: in accordance with ISO 11680-1 (Annex B)

** Sound Power Level: in accordance with ISO 11680-1 (Annex B)

*** Vibration Level: in accordance with ISO 11680-1 (Annex C)

Product Description

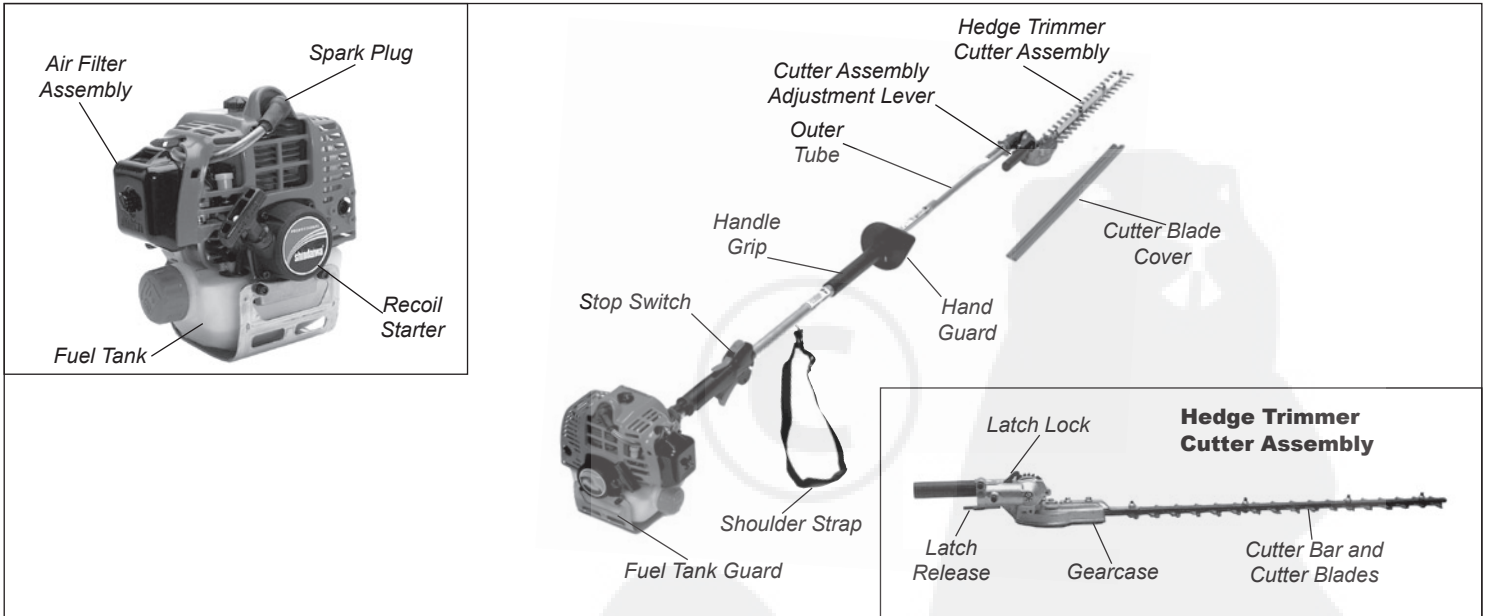

Prior To Assmebly

Using figure above as a guide, familiarize yourself with the Shindaiwa AH230 articulated hedge trimmer and its various components. Understanding your unit helps ensure top performance, longer service life, and safer operation.

Standard Equipment

Tool kit containing a spark plug wrench, 4mm hex wrench, and 8x10 spanner.

Before assembling, make sure you have all the components required for a complete unit:

- Engine assembly
- Outer tube/cutter assembly
- Kit with this manual and tool kit for routine maintenance.
- Cutter blade cover

Carefully inspect all components for damage.

IMPORTANT!

The terms "left", "left-hand", and "LH"; "right", "right-hand", and "RH"; "front" and "rear" refer to directions as viewed by the operator during normal operation.



WARNING!

Do not make unauthorized modifications or alterations to your articulating hedge trimmer or its components.

Powerhead Installation

1. Place the powerhead on a clean, flat surface, spark plug facing up.

CAUTION!

Do not remove the D-shaped shim washer! The D-shaped shim washer prevents damage from overtightening the tube clamp screw.

2. Use the 4mm hex wrench to loosen the tube clamp screw. Verify that the D-shaped shim washer is positioned as shown below.

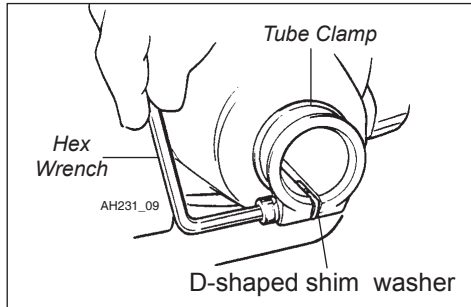

3. Remove the protective cap from the end of the outer tube.
4. Add some moly-type EP grease to splines at the end of the main shaft.

CAUTION!

Do not force the shaft tube into the powerhead! Excessive force can damage the shaft tube and mainshaft.

5. Slide the outer tube into the tube clamp until the tube bottoms. If installation is difficult, rotate the outer tube or main shaft slightly until you feel the mainshaft splines engage with the powerhead. Outer tube needs to be inserted so that end of grip hits joint cap.
6. Position the outer tube so that the ignition switch is facing up and the throttle lever is facing down.
7. Tighten the clamp screw firmly.

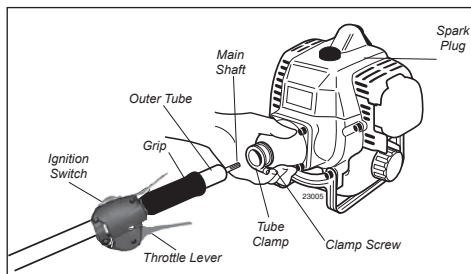

Connecting The Throttle Cable

Remove The Cylinder Cover

1. Remove the spark plug cap, then loosen the cylinder cover knob (about a dozen turns needed).

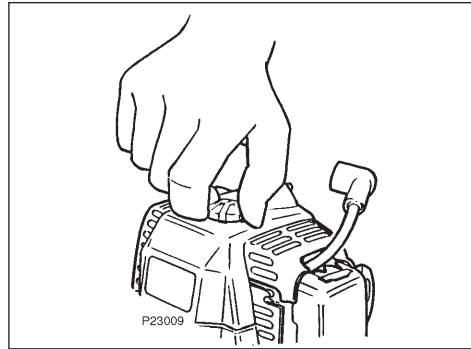

2. Lift the corner of the cylinder cover just below the muffler as shown, and lift off the cylinder cover.

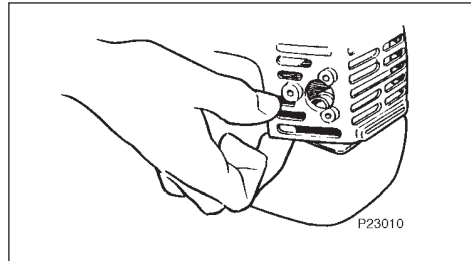

3. Turn the cable adjuster nuts sufficiently for the throttle cable to fit in the notch on the fan cover. Make sure the ignition ground lead is located on the rearward side of the notch. Then, connect the male fitting of the black ignition wire into the female fitting of the red wire attached to the engine.

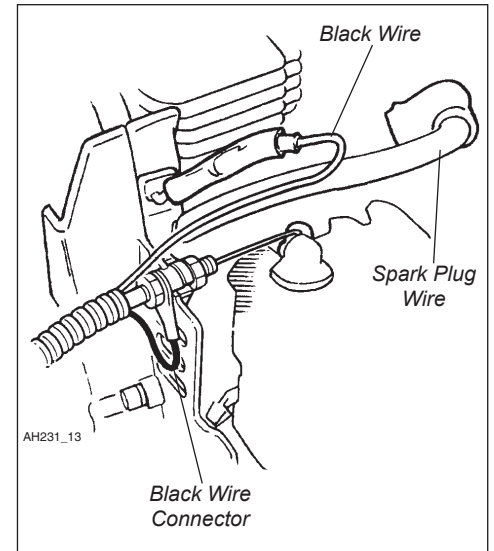

Connect The Throttle Cable

1. Loop the ribbed cable assembly to the top left side of the engine. Notice that the black ground wire (with a ring fitting on the end) is located between the two cable adjuster nuts as shown below.

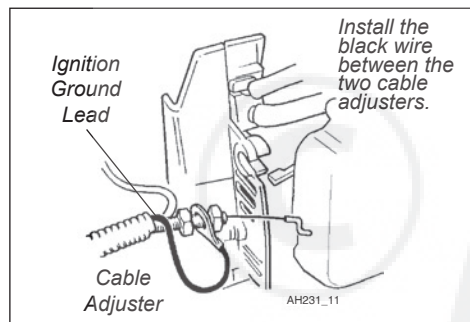

2. Connect the S-shaped end of the throttle cable to the throttle lever on top of the carburetor as shown below.

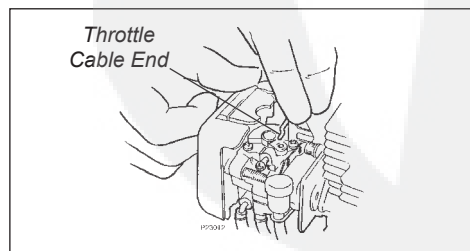

Adjusting the Throttle Cable

1. Loosen the two 10 mm throttle cable nuts at the fan cover as shown below.

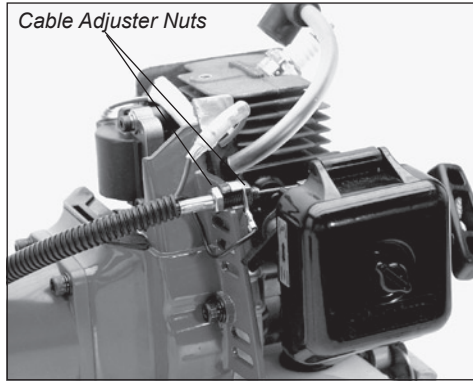

2. Adjust the throttle cable nuts until you achieve a free play on the throttle trigger of about 6 mm.

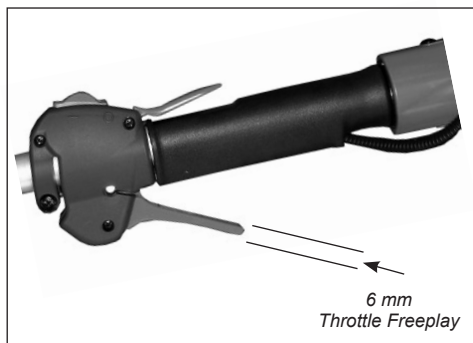

IMPORTANT!

Make sure the stop switch wires do not interfere with throttle functions. Reposition wires if necessary.

3. When 6 mm free play is achieved, tighten the two 10mm throttle cable nuts. When the throttle cable is correctly adjusted, and the throttle trigger is fully depressed (full throttle), the throttle will contact the stop on the throttle body.

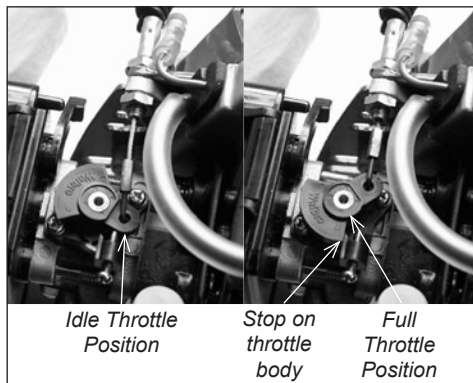

Idle Throttle Position

Stop on throttle body

Full Throttle Position

NOTE:

Put some Never-Seez™ or equivalent on the cylinder cover knob for easier removal.

4. Replace the cylinder cover.
5. Replace the spark plug cap.

Adjusting the Hedge Trimmer Cutter Assembly



WARNING!

- The cutter blades are very sharp. Do not grasp the blades with your hands. Do not brush the blades against your body.
- Never run the engine nor operate the articulated hedge trimmer when the cutter assembly is in the storage/transport position.

IMPORTANT!

Always use gloves when working near the cutter assembly.

Position the hedge trimmer on a flat, level surface with the engine resting on the fuel tank guard. Make sure the cover is in place on the blade.

1. With your right hand, grasp the handle, located immediately behind the hand guard. With your left hand, grip the adjustment lever on the cutter assembly.

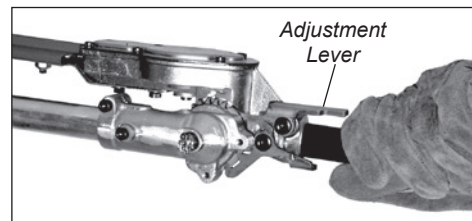

IMPORTANT!

The latch lock helps prevent inadvertent the latch release.

2. With the index finger of your left hand, press the latch release. With your left thumb, press the latch lock.

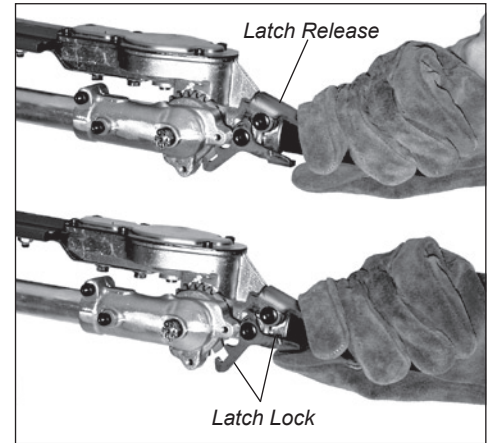

3. While holding the latch lock down, pivot the cutter assembly using the adjustment lever until it is straight with the outer tube (pivot 180°).

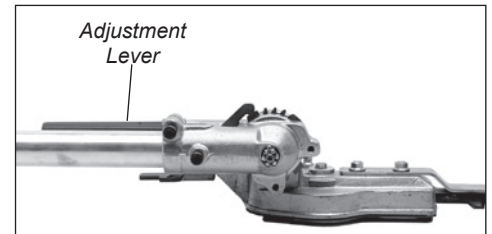

4. Release the latch lock and the latch release. Make sure the latch lock and the latch release return securely to a locking position.

5. Remove the cover from the cutter blade. The engine now may be started (refer to page 10 for procedures).

Adjusting the Hedge Trimmer Cutter Assembly for Desired Cutting Angles



WARNING!

Do not touch the cutter blades when the engine is running. The blades can oscillate even if the engine is idling.

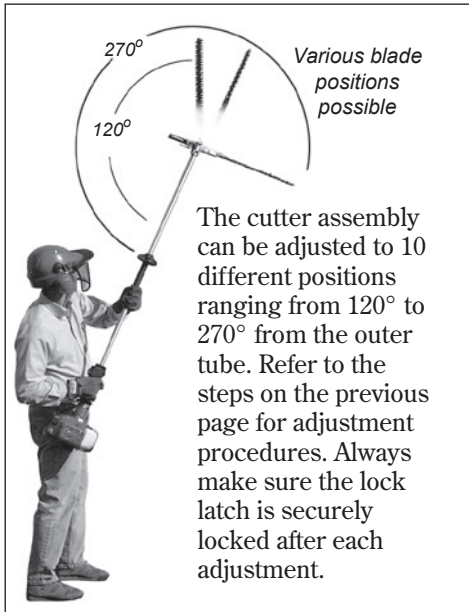

The cutter assembly can be adjusted to 10 different positions ranging from 120° to 270° from the outer tube. Refer to the steps on the previous page for adjustment procedures. Always make sure the lock latch is securely locked after each adjustment.

Adjusting the Cutter Assembly for Storage or Transportation



WARNING!

Never run the engine when adjusting the cutter assembly to the storage position.

1. With the engine off, install the cover onto the blade.
2. Using the procedures described on the previous page, rotate the cutter assembly so it is parallel to the tube. Make sure the latch lock and the latch release return securely to a locking position.
3. Make sure the scabbard is in place on the cutters before storing or transporting.

Gearcase rotated to the storage/transportation position

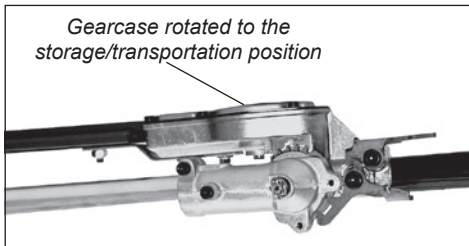

Mixing Fuel



WARNING!

Minimize the risk of fire, burns, and personal injury!

- **STOP** engine before refueling.
- **ALWAYS** allow the engine to cool before refueling
- **ALWAYS** open the fuel cap slowly to allow any pressure build-up in the tank to release fuel vapor slowly.
- **ALWAYS** transport and store fuels in an approved container.
- Avoid overfilling and wipe-up all spilled fuel. Move the engine at least 3 meters from the fueling point, storage area, and other readily flammable materials before restarting.
- **ALWAYS** inspect the unit for fuel leaks before each use. During each refill, make sure there are no fuel leaks around the fuel cap and/or tank. If a fuel leak is evident, stop using the unit immediately. Fuel leaks must be repaired before using the unit.
- **Never** smoke or light any fires near the engine or fuel source.
- **NEVER** place any flammable material near the engine or muffler.
- **NEVER** operate the engine without the muffler in good working condition.

CAUTION!

This engine is designed to operate on a 50:1 mixture consisting of unleaded gasoline and a premium 2-cycle mixing oil only. Use of Non-approved mixing oils can lead to excessive maintenance costs and/or engine damage.

CAUTION!

Some gasolines contain alcohol as an oxygenate! Oxygenated fuels may cause increased operating temperatures. Under certain conditions, alcohol-based fuels may also reduce the lubricating qualities of some mixing oils. Never use any fuel containing more than 10% alcohol by volume! Generic oils and some outboard motor oils may not be intended for use in high-performance air cooled 2-cycle engines, and should never be used in your Shindaiwa engine!

Filling The Fuel Tank

IMPORTANT!

Mix only enough fuel for your immediate needs! If fuel must be stored longer than 30-days, it should first be treated with a stabilizer such as StaBil™ or equivalent product!

1. Use only fresh, clean unleaded gasoline with a pump octane rating of 87 or higher.
2. Mixing fuel with a Premium 2-cycle mixing oil designed for use with high-performance 2-cycle air-cooled engines.
3. Refer to the following examples of 50:1 fuel to oil mix quantities:

Gasoline liters	2-cycle mixing oil milliliters
2.5 l	50 ml
5 l	100 ml
10 l	200 ml
20 l	400 ml

CAUTION!

Never attempt to mix fuel in the unit's fuel tank. Always mix all fuels in a clean approved container.

1. Place the hedge trimmer on a flat, level surface, and wipe any debris from around the fuel cap.
2. Remove the fuel cap.
3. Fill the tank with clean, fresh fuel.
4. Replace the cap, and wipe away any spilled fuel before starting the blower engine.

Starting the Engine

IMPORTANT!

Engine ignition is controlled by a two position switch mounted on the throttle housing labeled, "I" for ON or START and "O" for OFF or STOP.

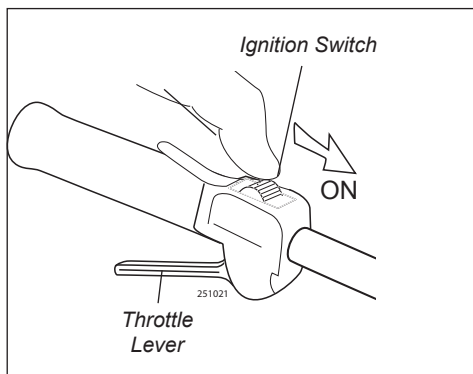

1. Slide the ignition switch to the "ON" position.

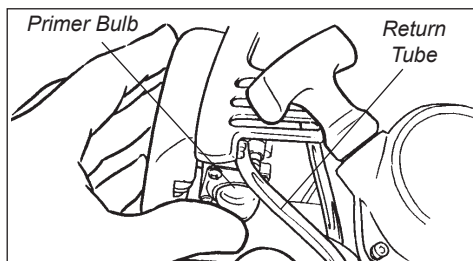

2. Press the primer bulb until fuel can be seen flowing in the transparent return tube.

IMPORTANT!

The primer system only pushes fuel through the carburetor. Repeatedly pressing the primer bulb will not flood the engine with fuel.

3. Set the choke lever to the CLOSED position if engine is cold.

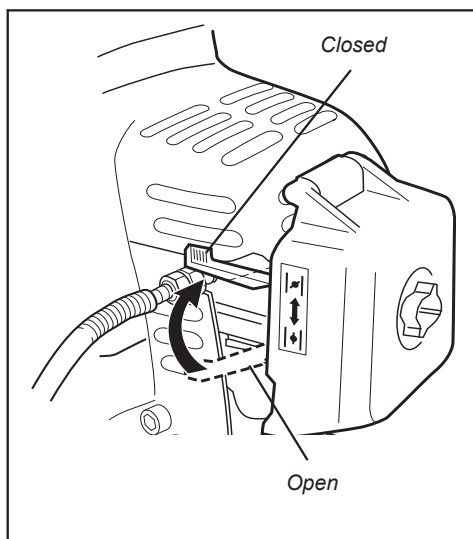

NOTE:

Before starting the engine, make sure the cutter assembly is in the cutting position (extended). Never start the engine with the cutter assembly in the storage/transportation position.

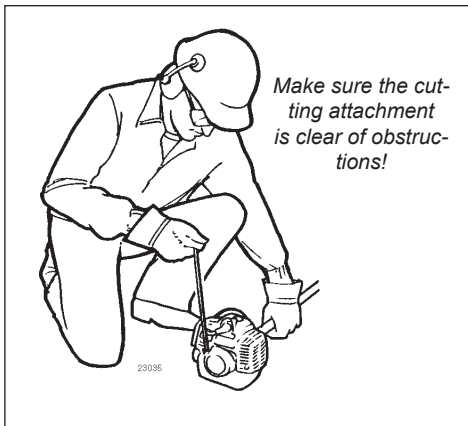

4. While holding the outer tube firmly with left hand. Use your other hand to slowly pull the recoil starter until resistance is felt, then pull quickly to start the engine.

CAUTION!

Do not pull the recoil starter to the end of the rope travel. Pulling the recoil starter to the end of the rope travel can damage the starter.



WARNING!

The cutting blades may move (oscillate) when the engine is started. Keep away from the cutter assembly while starting the engine.

5. When the engine starts, slowly move the choke lever to the "OPEN" position. (If the engine stops after the initial start, close the choke and restart.)

IMPORTANT!

If the engine fails to start after several attempts with the choke in the closed position, the engine may be flooded with fuel. If flooding is suspected, move the choke lever to the open position and repeatedly pull the recoil starter to remove excess fuel and start the engine. If the engine still fails to start, refer to the troubleshooting section of this manual.

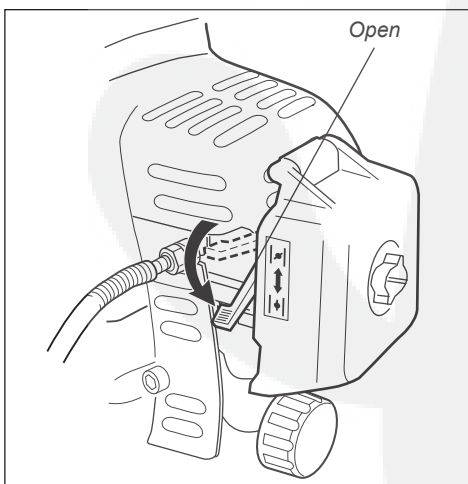

WARNING!

Never start the engine from the operating position.

When the Engine Starts...

- After the engine starts, allow the engine to warm up at idle 2 or 3 minutes before operating the unit.
- After the engine is warm, pick up the unit and clip on the shoulder strap if so equipped.
- Advancing the throttle makes the cutting attachment oscillate faster; releasing the throttle permits the attachment to stop oscillating. If the cutting attachment continues to oscillate when the engine returns to idle, carburetor idle speed should be adjusted (see "Adjusting The Carburetor" on the next page).

Stopping the Engine



WARNING!

The cutter attachment can continue moving after the engine is stopped!

1. Cool the engine by allowing it to idle for two or three minutes.
2. Slide the ignition switch to the "O" or STOP position.

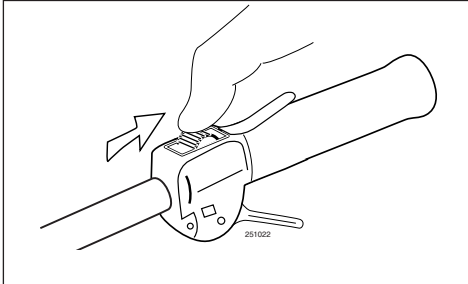

WARNING!

Know how to stop the machine quickly in an emergency.

Adjusting The Carburetor



WARNING!

The cutter attachment must never oscillate at engine idle speed. If the idle speed cannot be adjusted by the procedures described here, return the trimmer to your Shindaiwa dealer for inspection.

NOTE:

The mixture of the carburetor on this unit cannot be adjusted.

The engine must return to idle speed whenever the throttle trigger is released. Idle speed is adjustable and must be set low enough to permit the engine clutch to disengage the cutter attachment when throttle trigger is released.

Check and Adjust Idle Speed

1. Start the engine and allow it to idle two or three minutes, or until it warms up.
2. If the cutter attachment oscillates at engine idle, reduce idle speed by turning the idle adjusting screw counter-clockwise as necessary.

IMPORTANT!

Use a tachometer, if one is available, to set engine idle. Standard idle speed is: 2,750 (\pm 250) min⁻¹.

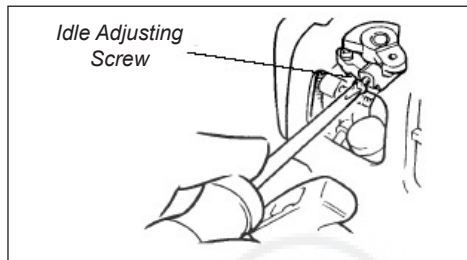

3. If the engine is stalling and won't idle, increase idle speed by turning the idle adjustment screw clockwise.

Attaching The Shoulder Strap

To Wear the Shoulder Strap

1. Hook the strap hook to the hanger on the outer pipe.
2. Wear the shoulder strap so that the hook stays at your right hand side.
3. Adjust the length of the shoulder strap so that you can hold and operate the machine comfortably.

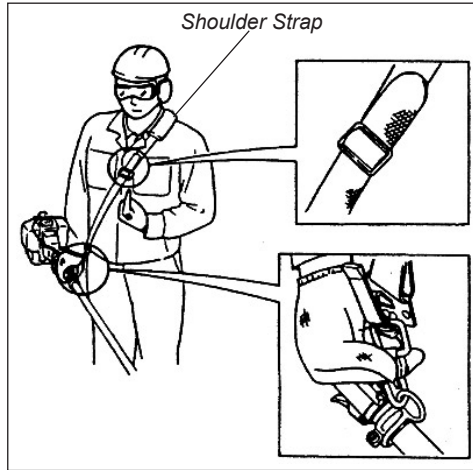

Emergency Release

In case of emergency, strongly pull the white tab at the hook. The machine will be released from the strap.

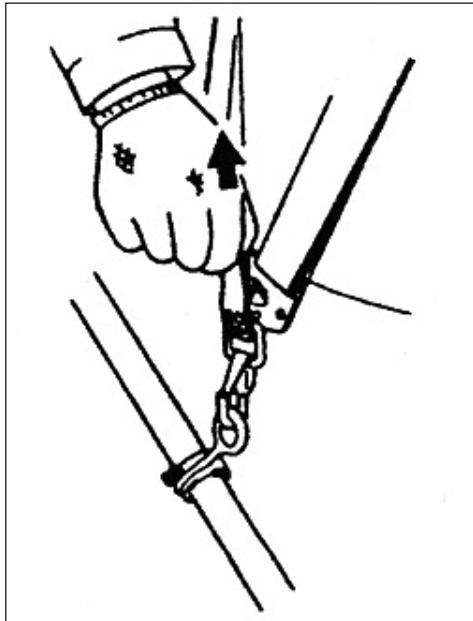

Using The Hedge Trimmer

Applications

Preparations

Use lopping shears to cut out thick branches first.

Cutting Sequence

If a radial cut is necessary, cut a little at a time in several passes.

Cutting Techniques

Vertical Cut:

Swing the blade up and down in an arc as you move along the hedge - use both sides of the cutting blade.

Cutting without standing directly next to hedge, e.g. flower bed between operator and hedge.

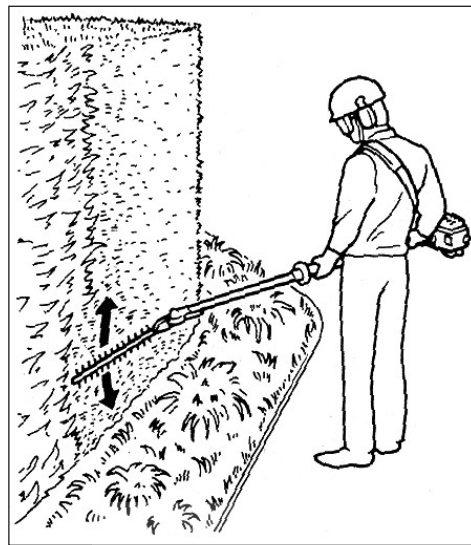

Overhead Cut

Hold the shaft upright with a 90° blade angle to cut an upper surface of a hedge.

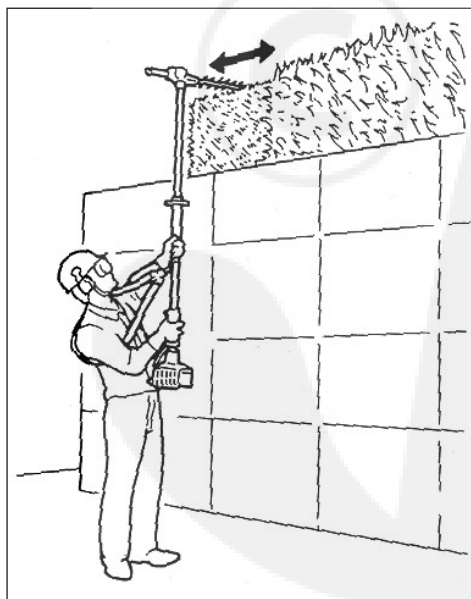

Horizontal Cut:

Hold the cutting blade at an angle of 0° to 10° as you swing the hedge trimmer horizontally.

Swing the blade in an arc towards the outside of the hedge so that the cuttings are swept on to the ground.

Cutting without standing directly in front of the hedge, e.g. reaching over a flower bed.

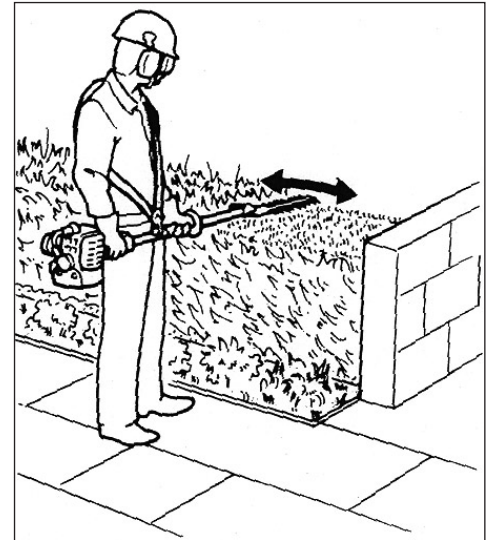

Cutting close to ground from a standing position, e.g. low shrubs. See below.



General Maintenance



WARNING!

Before performing any maintenance, repair, or cleaning work on the unit, make sure the engine and cutting attachment are completely stopped. Disconnect the spark plug wire before performing service or maintenance work.



WARNING!

Non-standard accessories, cutting attachment, or replacement parts may not operate properly with your unit and may cause damage and lead to personal injury.

Spark Plug

Keep the spark plug and wire connections tight and clean.

Daily Maintenance

Prior to each work day, perform the following:

- Remove all dirt and debris from the engine, check the cooling fins and air cleaner for clogging, and clean as necessary.

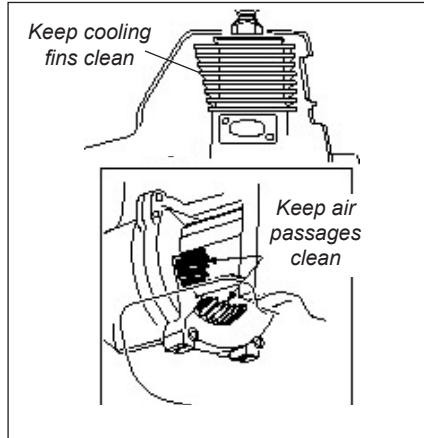

- Carefully remove any accumulations of dirt or debris from the muffler and fuel tank. Check cooling air intake area at base of crankcase. Remove all debris. Dirt build-up in these areas can lead to engine overheating, fire, or premature wear.



WARNING!

Always wear gloves when working around the cutter assembly.

- Clean any debris or dirt from the cutting attachment.
- Lubricate the blades before use and after refueling. Check the cutters for damage or incorrect adjustment.
- Check for loose or missing screws or components. Make sure the cutter attachment is securely fastened.
- Check the entire unit for leaking fuel or grease.
- Make sure nuts, bolts, and screws (except carburetor idle speed adjusting screws) are tight.

10-Hour Maintenance

Every 10 hours of operation (more frequently in dusty or dirty conditions):

Remove the air cleaner element from the air cleaner housing and clean it thoroughly with soap and water. Let it dry before reinstalling the element.

CAUTION!

Do not operate the unit if the air cleaner or element is damaged, or if the element is wet.

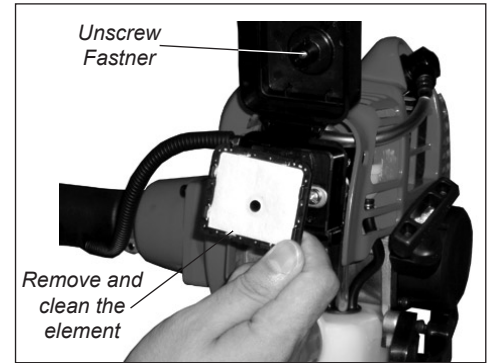

10/15-Hour Maintenance

50-hour Maintenance

Every 10 to 15 hours of operation:

- Remove and clean the spark plug. Adjust the spark plug electrode gap to 0.6 ~ .07 mm. If the plug must be replaced, use only a NGK BMR6A.

CAUTION!

Before removing the spark plug, clean the area around the plug to prevent dirt and debris from getting into the engine's internal parts

Clean the spark plug and check the gap at the electrode.

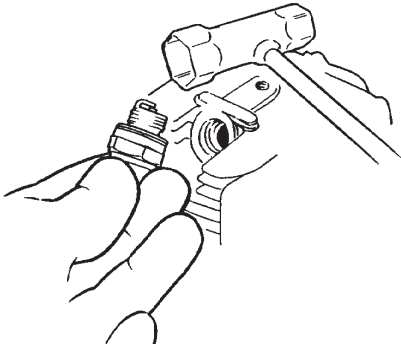
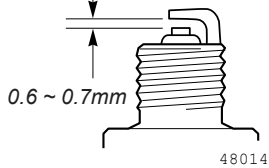

- Lubricate the cutter assembly gearbox by pumping one or two strokes of lithium-base grease into the grease fitting using a lever-type grease gun.

CAUTION!

Overlubricating can cause the gearbox to operate sluggishly and can cause grease to leak out.

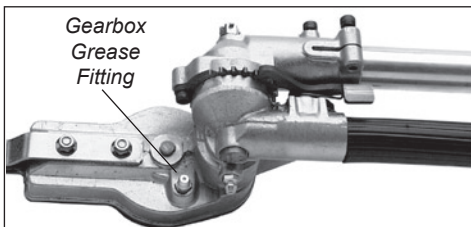

Every 50 hours of operation (more frequently in dusty or dirty conditions):

- Remove and clean the cylinder cover and clean dirt and debris from the cylinder cooling fins.
- Lubricate the gearcase.** To perform this operation, first remove the gearcase from the outer tube as follows:

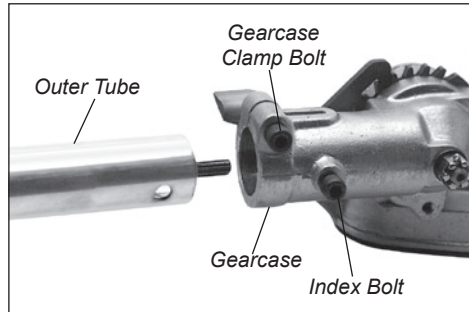

CAUTION!

Do not remove the D-shaped shim washer from the gearcase clamp! The shim washer prevents damage from overtightening the tube clamp screw.

- Loosen the gearcase clamp bolt.
- Remove the index bolt from the gearcase.
- Slide the gearcase out of the tube.
Using a grease gun, pump lithiumbase grease (about 10 grams) into the grease fitting on the gearcase until you see old grease being purged from the gearcase. Purged grease will be visible in the outer tube cavity. Clean up excess grease, then reassemble the gearcase onto the outer tube. Make sure the index bolt fits into the hole on the outer tube. Securely tighten both bolts.

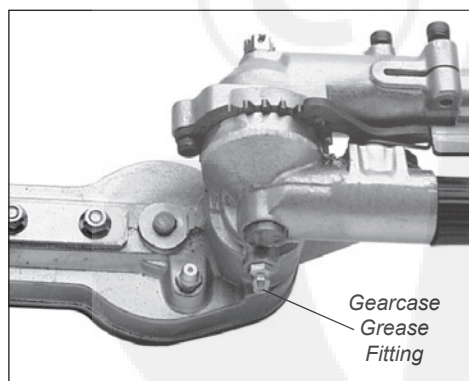

Servicing The Fuel Filter

- Use a hooked wire to extract the fuel filter from inside the fuel tank. Inspect the fuel filter element for signs of contamination. Replace it with a new one if required. Before reinstalling the filter, inspect the fuel line. If you find damage or deterioration, remove the unit from service until it can be inspected by a Shindaiwa-trained service technician.

CAUTION!

Make sure you do not pierce the fuel line with the end of the hooked wire. The line is delicate and can be damaged easily.

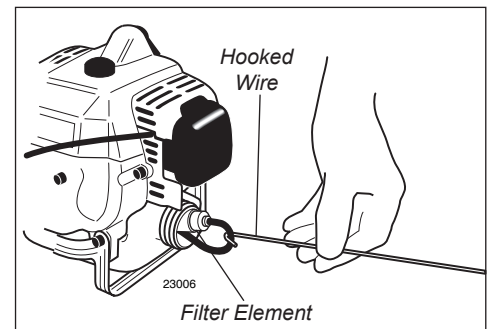

Cutter Blade Adjustment



WARNING!

The cutter blades are very sharp! Always wear gloves when working around the cutter assembly.

CAUTION!

Operating the trimmer with worn or improperly adjusted cutters will reduce cutter performance and may also damage your unit.

Cutter performance of your unit depends in great measure on cutter blade clearance. Properly adjusted blades will oscillate freely yet help prevent binding of cut material between blades. Adjust blades as follows:

1. Loosen all blade locknuts at least one full turn.
2. Tighten each blade shoulder bolt firmly, and then loosen the shoulder bolts 1/4 to 1/2 turn.
3. Working from the gearcase end, lock each bolt in place by firmly tightening its locknut while preventing the shoulder bolt from turning.

When shoulder bolt adjustment is correct, there should be a gap of 0.25–0.50 mm between the cutter blades and the flat washers, and the flat washer beneath each bolt head should turn freely.

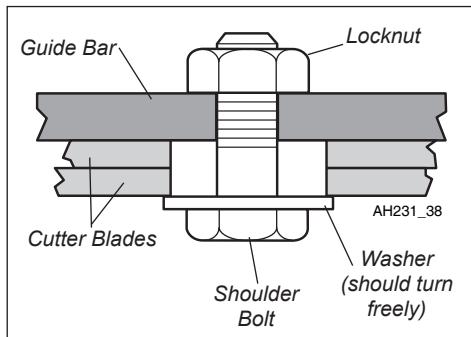

Long Term Storage

Whenever the unit will not be used for 30 days or longer, use the following procedures to prepare it for storage:

- Clean external parts thoroughly and apply a light coating of oil to all metal surfaces.
- Drain all the fuel from the fuel tank.

IMPORTANT!

All stored fuels should be stabilized with a fuel stabilizer such as STA-BIL™.

To remove the remaining fuel from the fuel lines and carburetor and with the fuel drained from the fuel tank.

1. Prime the primer bulb until no more fuel is passing through.
2. Start and run the engine until stops running.
3. Repeat steps 1 and 2 until the engine will no longer start.

CAUTION!

Gasoline stored in the carburetor for extended periods can cause hard starting, and could also lead to increased service and maintenance costs.

- Remove the spark plug and pour about 3 ml of 2-cycle mixing oil into the cylinder through the spark plug hole. Slowly pull the recoil starter 2 or 3 times so oil will evenly coat the interior of the engine. Reinstall the spark plug.
- Before storing the unit, repair or replace any worn or damaged parts.
- Remove the air cleaner element from the carburetor and clean it thoroughly with soap and water. Let dry and reassemble the element.
- Store the unit in a clean, dust-free area.

Troubleshooting Guide

Engine Does Not Start

What To Check	Possible Cause	Remedy
Does the engine crank? YES ↓	NO → Faulty recoil starter. Fluid in the crankcase. Internal damage.	Consult with an authorized servicing dealer.
Good compression? YES ↓	NO → Loose spark plug. Excess wear on cylinder, piston, rings.	Tighten and re-test. Consult with an authorized servicing dealer.
Does the tank contain fresh fuel of the proper grade? YES ↓	NO → Fuel incorrect, stale, or contaminated; mixture incorrect.	Refill with clean fresh unleaded gasoline with a pump octane of 87 or higher, mixed with Premium 2-cycle mixing oil at a 50:1 gasoline/oil ratio.
Is fuel visible and moving in the return line when priming? YES ↓	NO → Check for clogged fuel filter and/or vent.	Replace fuel filter or vent as required. Restart.
Is there spark at the spark plug wire terminal? YES ↓	NO → The ignition switch is in "O" (OFF) position. Shorted ignition ground. Faulty ignition unit.	Move switch to "I" (ON) position and re-start. Consult with an authorized servicing dealer.
Check the spark plug.	If the plug is wet, excess fuel may be in the cylinder. The plug is fouled or improperly gapped. The plug is damaged internally or of the wrong size.	Crank the engine with the plug removed, replace the plug, and re-start. Clean and re-gap the plug to 0.6 ~ 0.7 mm. Re-start. Replace the plug with a NGK BMR6A. Re-start.

Troubleshooting Guide (Continued)

Low Power Output

What To Check	Possible Cause	Remedy
Is the engine overheating?	Operator is overworking the unit.	Cut at a slower rate.
	Carburetor mixture is too lean.	Consult with an authorized servicing dealer.
	Improper fuel ratio.	Refill with clean fresh unleaded gasoline with a pump octane of 87 or higher, mixed with Premium 2-cycle mixing oil at a 50:1 gasoline/oil ratio.
	Fan, fan cover, cylinder fins dirty or damaged.	Clean, repair or replace as necessary.
	Carbon deposits on the piston or in the muffler.	Consult with an authorized servicing dealer.
Engine is rough at all speeds. May also have black smoke and/or unburned fuel at the exhaust.	Clogged air cleaner element.	Clean or replace the air filter.
	Loose or damaged spark plug.	Tighten or replace the plug with a NGK BMR6A. Re-start.
	Air leakage or clogged fuel line.	Repair or replace fuel filter and/or fuel line.
	Water in the fuel.	Refill with fresh fuel/oil mixture.
	Piston seizure.	Consult with an authorized servicing dealer.
	Faulty carburetor and/or diaphragm.	Consult with an authorized servicing dealer.
Engine is knocking.	Overheating condition.	See above.
	Improper fuel.	Check fuel octane rating; check for presence of alcohol in the fuel. Refuel as necessary.
	Carbon deposits in the combustion chamber.	Consult with an authorized servicing dealer.

Troubleshooting Guide (Continued)

Additional Problems

Symptom	Possible Cause	Remedy
<div style="border: 1px solid black; padding: 5px; width: fit-content;">Poor acceleration.</div>	Clogged air filter.	Clean or replace the air filter.
	Clogged fuel filter.	Replace the fuel filter.
	Lean fuel/air mixture.	Consult with an authorized servicing dealer.
	Idle speed set too low.	Adjust: 2,750 (\pm 250) min ⁻¹
<div style="border: 1px solid black; padding: 5px; width: fit-content;">Engine stops abruptly.</div>	Switch turned off.	Reset the switch and re-start.
	Fuel tank empty.	Refuel. See page 9.
	Clogged fuel filter.	Replace fuel filter.
	Water in the fuel.	Drain; replace with clean fuel. See page 9.
	Shorted spark plug or loose terminal.	Clean or replace spark plug with a NGK BMR6A. Tighten the terminal.
	Ignition failure.	Replace the ignition unit.
Piston seizure.	Consult with an authorized servicing dealer.	
<div style="border: 1px solid black; padding: 5px; width: fit-content;">Engine difficult to shut off.</div>	Ground (stop) wire is disconnected, or switch is defective.	Test and replace as required.
	Overheating due to incorrect spark plug.	Replace spark plug with a NGK BMR6A.
	Overheated engine.	Idle engine until cool.
<div style="border: 1px solid black; padding: 5px; width: fit-content;">Cutting attachment moves at engine idle.</div>	Engine idle too high.	Set idle: 2,750 (\pm 250) min ⁻¹
	Broken clutch spring or worn clutch spring boss.	Replace spring/shoes as required, check idle speed.
	Loose attachment holder.	Inspect and re-tighten holders securely.
<div style="border: 1px solid black; padding: 5px; width: fit-content;">Excessive vibration</div>	Warped or damaged attachment.	Inspect and replace attachment as required.
	Loose gearcase.	Tighten gearcase securely.
	Bent main shaft/worn or damaged bushings.	Inspect and replace as necessary.
<div style="border: 1px solid black; padding: 5px; width: fit-content;">Attachment will not rotate</div>	Shaft not installed in powerhead or gearcase.	Inspect and reinstall as required.
	Broken shaft.	Consult with an authorized servicing dealer.
	Damaged gearcase.	Consult with an authorized servicing dealer.

DECLARATION OF CONFORMITY

We hereby declare the Shindaiwa Articulated Hedge Trimmer,
Model AH230 (AH230/EC1).

meets the following respective requirements.

Council Directives:

89/336/EEC as amended
98/37/EC as amended
2000/14/EC as amended
2004/26/EC as amended

Standard taken:

EN 292 parts 1&2
ISO 11680-1
CISPR 12

Measured sound power level: 106dB(A)

Guaranteed sound power level: 108dB(A)

Technical documentaiton is kept by:

K. Maeda DIV. Manager
Engineering Research and Development DIV.

Shindaiwa Kogyo Co.,Ltd.

Head office : 6-2-11, Ozuka-Nishi, Asaminami-Ku,
Hiroshima, 731-3167, Japan

TEL:81-82-849-2003 , FAX:81-82-849-2482

13 December, 2004



T. Yoshitomi
DIV. Manager
Quality Assurance DIV.

Shindaiwa Kogyo Co.,Ltd.

Head office : 6-2-11, Ozuka-Nishi, Asaminami-Ku,
Hiroshima, 731-3167, Japan

TEL:81-82-849-2206 , FAX:81-82-849-2481

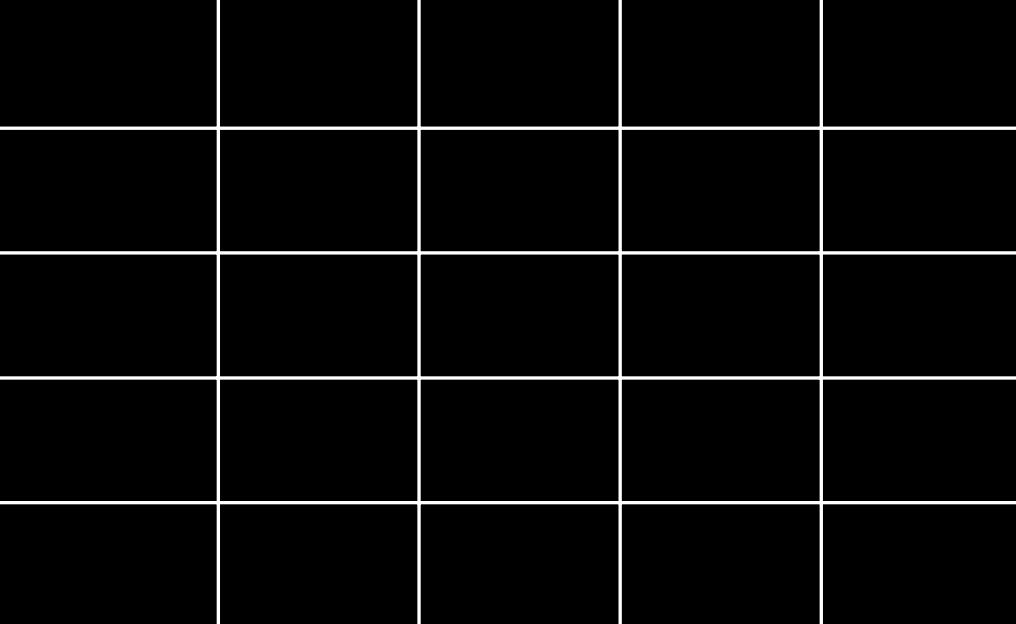

shindaiwa

Shindaiwa Inc.
11975 SW Herman Rd.
Tualatin, Oregon 97062
U.S.A.
Telephone: 503 692-3070
Fax: 503 692-6696
www.shindaiwa.com

Shindaiwa Kogyo Co., Ltd.
6-2-11, Ozuka-Nishi,
Asaminami-Ku, Hiroshima
731-3167, Japan
Telephone: 81-82-849-2220
Fax: 81-82-849-2481

© 2004 Shindaiwa, Inc.
Part Number 62849-94310
Revision 12/04

Shindaiwa is a registered trademark of Shindaiwa, Inc.
Specifications subject to change without notice.

