



SHINDAIWA OWNER'S/OPERATOR'S MANUAL
P230 POLE PRUNER



WARNING!



Minimize the risk of injury to yourself and others! Read this manual and familiarize yourself with the contents. Always wear eye and hearing protection when operating this unit.

Do not operate or service this machine unless you clearly understand this manual.

Introduction

The Shindaiwa P230 Pole Pruner is designed and built to deliver superior performance and reliability without compromise to quality, comfort, safety or durability.

Shindaiwa's high-performance engines represent the leading edge of 2-cycle engine technology, delivering exceptionally high power with remarkably low displacement and weight. As an owner/operator, you'll soon discover for yourself why Shindaiwa is simply in a class by itself! The procedures described in this manual are intended to help you get the most from your machine as well as to protect you and others from harm. These procedures are guidelines for safe operation under most conditions, and are not intended to replace any safety rules and/or laws that may be in force in your area.

If you have questions regarding your power tool, or if you do not understand something in this manual, your Shindaiwa dealer will be glad to assist you.

IMPORTANT!

The information contained in these instructions describes units available at the time of publication. While every attempt has been made to provide the latest information about your Shindaiwa product, there may be some differences between your P230 and what is described here. Shindaiwa Inc. reserves the right to make changes to products without prior notice and without obligation to make alterations to units previously manufactured.

The procedures described in this manual are intended to help you get the most from your unit as well as to protect you and others from harm. These procedures are guidelines for safe operation under most conditions, and are not intended to replace any safety rules and/or laws that may be in force in your area.

If you have questions regarding your power tool, or if you do not understand something in this manual, your Shindaiwa dealer will be glad to assist you.

You may also contact Shindaiwa, Inc. at the address printed on the back of this Manual.

Contents

	PAGE
Attention Statements	2
Warning Labels	3
Kickback Precautions.....	3
Operating Precautions.....	4
Product Description.....	6
Technical Specifications	7
Assembly.....	7
Installing Guide the Bar and Saw Chain.....	9
Adjusting the Chain	10
Chain Oiler.....	10
Mixing Fuel	11
Starting the Engine.....	12
Stopping the Engine	13
Using the Pole Pruner.....	13
General Maintenance	14
Long Term Storage.....	16
Sharpening the Chain.....	17
Troubleshooting.....	18
Declaration of Conformity.....	21

Attention Statements

Throughout this manual are special "attention statements" surrounded by boxes and preceded by the triangular Attention Symbol.



DANGER!

A statement preceded by the triangular attention symbol and the word "DANGER" contains information that should be acted upon to prevent serious injury or death.



WARNING!

A statement preceded by the triangular attention symbol and the word "WARNING" contains information that should be acted upon to prevent serious bodily injury.

CAUTION!

A statement preceded by the word "CAUTION" contains information that should be acted upon to prevent mechanical damage.

IMPORTANT!

A statement preceded by the word "IMPORTANT" is one that possesses special significance.

NOTE:

A statement preceded by the word "NOTE" contains information that is handy to know and may make your job easier.

Safety Precautions



THE PRUNER IS NOT INSULATED AGAINST ELECTRICAL SHOCK! Approaching or contacting electrical line with the pruner could cause death or serious injury. Keep the pruner at least 10 meters away from electrical lines or branches that contact electrical lines.

A pole pruner operates at very high speeds and has the potential to do serious damage if misused, abused or mishandled. To reduce the risk of injury, you must maintain control at all times, and observe all safety precautions during operation. **Never permit a person without training or instruction to operate this pruner!**

Warning Labels

Warning labels affixed to the machine are as follows:



Read and follow this manual, make sure anyone using the pruner does likewise. Failure to do so could result in serious personal injury or machine failure. Keep this manual for future reference.



Always wear a hard hat to reduce the risk of head injuries during operation of this machine. In addition, always wear eye and hearing protection. Shindaiwa recommends wearing a face shield as additional face and eye protection.



Wear nonslip heavy-duty work gloves to improve your grip on the pole pruner handle. Wear sturdy footwear with nonslip soles to provide good footing. Steel-toe safety boots are recommended. Wear snug-fitting clothes that also permit freedom of movement.



Never operate this tool or any other power equipment if you are tired, ill, or under the influence of alcohol, drugs, or any substance that could affect your ability or judgement.



Keep bystanders at least 15 meters away from the operating pruner to reduce the risk of being struck by falling objects or thrown debris.



Never cut off branches over your head. The cut-off branches may hit you and cause serious injury.



Never operate the pruner at an angle greater than 60° in order to reduce the risk of being struck by falling objects during operation.



Never touch the saw chain when starting the engine and while operating this machine.



Chain oil fill/oil pump



Sound Power Level (measured in accordance with 2000/14/EC)

Kickback and Pinching Safety Precautions



WARNING!

Both kickback and pinching may cause you to lose control of the pole pruner which could result in serious personal injury. **Do not rely exclusively on the safety device built into the pruner!** You must take several steps to keep your jobs free from accident or injury:

1. Understand kickback and pinching! You can reduce or eliminate the element of surprise. Sudden surprise contributes to accidents.
2. Keep a firm grip on the pole pruner with both hands whenever the engine is running. A firm grip will help you reduce the effects of kickback and pinching as well as maintaining control of the unit.
3. Make sure the area in which you are cutting is free from obstructions. Do not let the nose of the guide bar contact a log, branch, or any other obstructions which could be hit while you operate the pole pruner.
4. Cut at high engine speeds.
5. Follow the manufacturer's instructions for sharpening and maintaining the chain.
6. Use only the replacement bar and chain or equivalent as specified by the manufacturer.

Beware of Kickback!

Kickback can occur whenever the tip of the guide bar touches an object while the saw is operating. Kickback may force the bar up and back toward the operator with lightning-like speed!

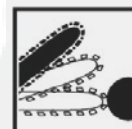

Beware of pinching.

Pinching the saw along the tip of the guide bar may force the bar back rapidly toward the operator. Pinching can occur whenever wood closes in around the moving chain.



The Properly Equipped Operator

Always wear a hard hat to reduce the risk of head injuries during operation of this unit.

Always wear eye and hearing protection. Shindaiwa recommends wearing a face shield as additional face and eye protection.

Wear nonslip heavy-duty work gloves to improve your grip on the pole pruner handle. Wear snug-fitting clothes that also permit freedom of movement. NEVER wear shorts!



Never operate the pruner at an angle greater than 60° in order to reduce the risk of being struck by falling objects during operation.

Always operate with both hands firmly gripping the unit.

Keep a proper footing and do not overreach—maintain your balance at all times during operation.

Wear sturdy footwear with nonslip soles to provide good footing. Steel-toed safety boots are recommended. Never operate unit bare-footed!

Keep bystanders at least 15 meters away from the operating pruner to reduce the risk of being struck by falling objects or thrown debris.

Operating Precautions



WARNING!

- Make sure the chain and sprocket are correctly adjusted before operating the pruner (see page 10 for adjustment procedures). **Never attempt chain adjustment with the engine running!**
- Always make sure the cutting attachment is properly installed and firmly tightened before operation.
- Never use a cracked or warped guide bar: replace it with a serviceable guide bar and make sure it fits properly.
- If a saw blade should bind fast in a cut, shut off the engine immediately. Push the branch or tree to ease the bind and free the blade.
- Make sure there are no missing or loose fasteners, and that the ignition switch and throttle controls are working properly.
- Before starting the engine, make sure the saw chain is not contacting anything.
- Make sure there is always good ventilation when operating the pruner. Fumes from engine exhaust can cause serious injury or death. **Never run the engine indoors!**
- Do not operate the unit with the muffler removed.
- When cutting a limb that is under tension, be alert for springback so that you will not be struck by the moving limb.
- Always stop the engine immediately and check for damage if you strike a foreign object or if the unit becomes tangled. Do not operate with broken or damaged equipment.
- Stop the unit immediately if it suddenly begins to vibrate or shake. Inspect for broken, missing or improperly installed parts or attachments.
- Never transport the unit nor set it down with the engine running. An engine that's running could be accidentally accelerated causing the chain to rotate.
- Make sure the chain cover is in place when transporting and storing the pruner.
- When carrying by hand, the chain should be pointing backward.

Operating Precautions (continued)



CAUTION!

- Always maintain the P230 pole pruner according to the this owner's manual and follow the recommended scheduled maintenance.
- Never modify or disable any of the pole pruner's safety devices.
- Always use genuine Shindaiwa parts and accessories when repairing or maintaining this unit.
- Do not make unauthorized modifications or substitutions to the guide bar or chain.
- Never allow the engine to run at high RPM without a load. Doing so could damage the engine.
- When transporting the pruner in a vehicle, tie it down securely to prevent damage and fuel spillage.
- Always clear your work area of trash or hidden debris to help ensure good footing.
- Keep the saw chain sharp and properly adjusted.
- Keep the pruner as clean as possible. Keep it free of loose vegetation, mud, etc.

Safety Equipment and Labels

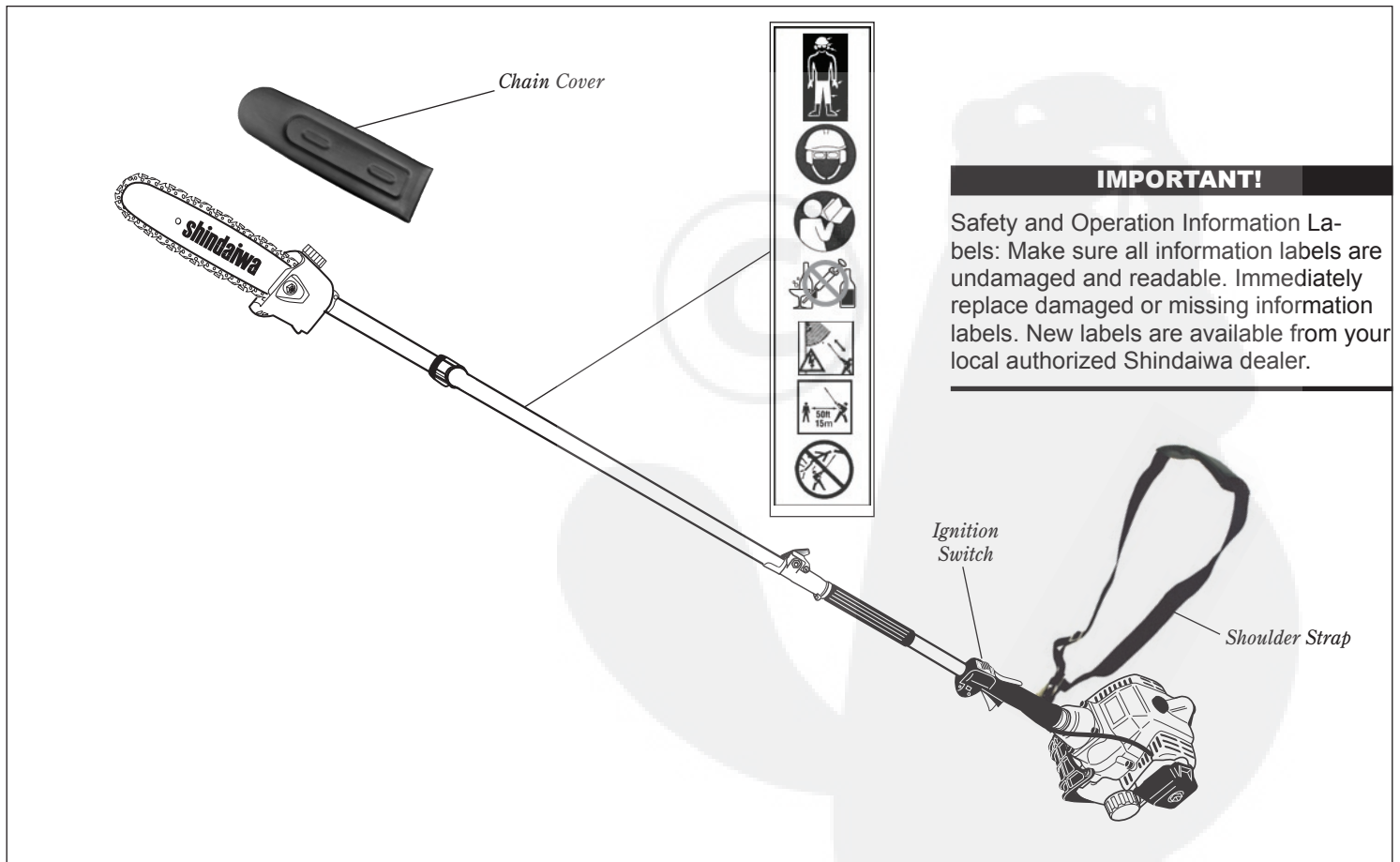

Product Description

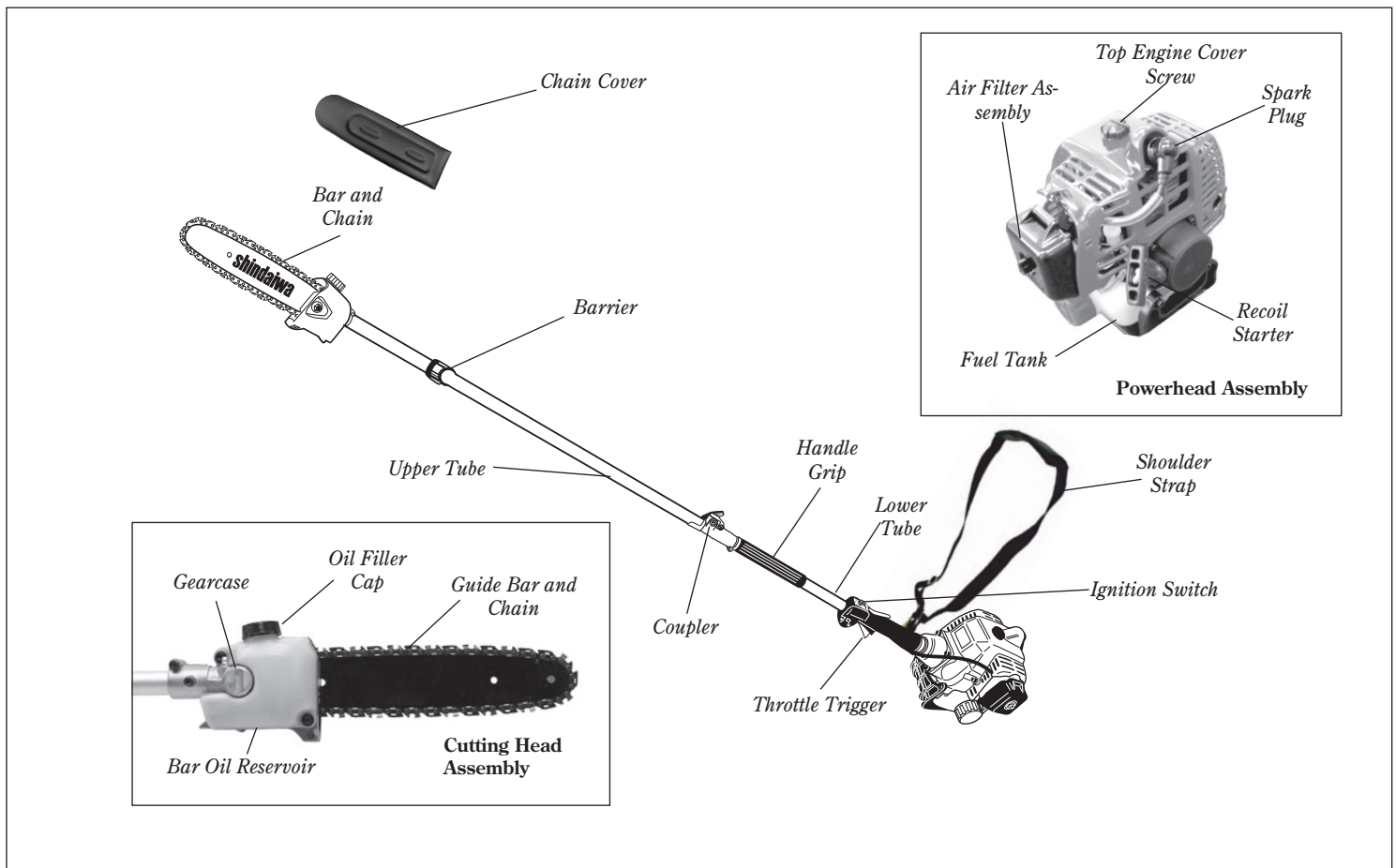

Prior To Assembly

Using Figure above as a guide, familiarize yourself with the Shindaiwa P230 pole pruner and its various components. Understanding your unit helps ensure top performance, longer service life, and safer operation.

Before assembling, make sure you have all the components required for a complete unit:

- Powerhead assembly
- Lower tube assembly
- Upper tube/saw assembly, chain and guide bar
- Chain Cover
- Shoulder Strap
- Tool Kit Containing:
 - Spark plug wrench
 - 4mm hex wrench
 - 8 x 10mm spanner

Carefully inspect all components for damage.

IMPORTANT!

The terms “left”, “left-hand”, and “LH”; “right”, “right-hand”, and “RH”; “front” and “rear” refer to directions as viewed by the operator during normal operation.



WARNING!

Do not make unauthorized modifications or alterations to your pruner or its components.

Bar and Chain Options

- 8 inch Bar - 90SG-33E Chain
- 10 inch Bar - 90SG-39E Chain
- 12 inch Bar - 90SG-44E Chain

Technical Specifications

Model Name.....	P230/EC1
Engine Model.....	S230EC1
Engine Type	2-cycle, vertical cylinder, forced air
Displacement.....	22.5 cm ³
Bore x Stroke.....	32mm x 28mm
Maximum Power Output	0.8 kW
Engine Speed at Idling	2,750 min ⁻¹
Maximum Engine Speed.....	10,000 min ⁻¹
Engine Speed at Maximum Power Output.....	7,500 min ⁻¹
Dry Weight	5.4 kg
Length with 10" bar assembly	2,800 mm
Fuel Tank Capacity	550 cm ³
Fuel/Oil Ratio.....	50:1
Carburetor	Walbro WYL
Ignition System	1 Piece Electronic, transistor controlled
Spark Plug.....	NGK BMR6A
Air Cleaner.....	Nonreversible flocked filter
Starting Method	Recoil Starter
Stopping Method.....	Slide Switch
Gearcase Ratio.....	1.06:1
Transmission Type	Automatic centrifugal clutch with bevel gear
Chain Guide Bar.....	3/8" pitch, .043" guage Micro-Lite™
Chain Type	3/8" pitch Micro-Lite™, .043" guage
Chain Speed.....	23.5m/sec. @ 10,000 min ⁻¹
Chain Lubrication.....	Automatic adjustable oiler
Chain Lubricant.....	Premium Bar and Chain Oil
Sprockets	3/8", fixed spur
Sound Pressure Level*	(Idling) 76dB (A) Racing 97dB (A)
Sound Power Level**	(Idling) 87 dB (A) Racing 109 dB (A)
Vibration Level***	(Idling [Front/Rear]) 1.7/3.0 m/s ² (Racing [Front/Rear]) 5.8/4.8 m/s ²

* Sound Pressure Level: in accordance with ISO 11680-1 (Annex B)

** Sound Power Level: in accordance with ISO 11680-1 (Annex B)

*** Vibration Level: in accordance with ISO 11680-1 (Annex C)

Powerhead Installation

1. Place the powerhead on a clean, flat surface, spark plug facing up.

CAUTION!

Do not remove the D-shaped shim washer! The D-shaped shim washer prevents damage from overtightening the tube clamp screw.

2. Use the 4mm hex wrench to loosen the tube clamp screw. Verify that the D-shaped shim washer is positioned as shown below.

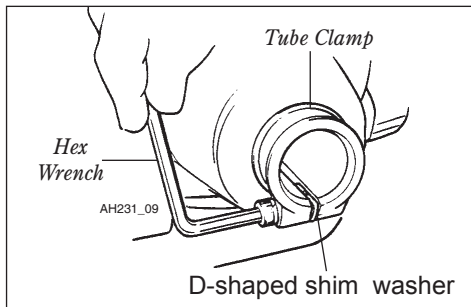

3. Remove the protective cap from the end of the outer tube.
4. Add some moly-type EP grease to splines at the end of the main shaft.

CAUTION!

Do not force the shaft tube into the powerhead! Excessive force can damage the shaft tube and mainshaft.

5. Slide the outer tube into the tube clamp until the tube bottoms. If installation is difficult, rotate the outer tube or main shaft slightly until you feel the mainshaft splines engage with the powerhead. Outer tube needs to be inserted so that the end of the grip hits joint cap.

6. Position the outer tube so that the ignition switch is facing up and the throttle lever is facing down.
7. Tighten the clamp screw firmly.

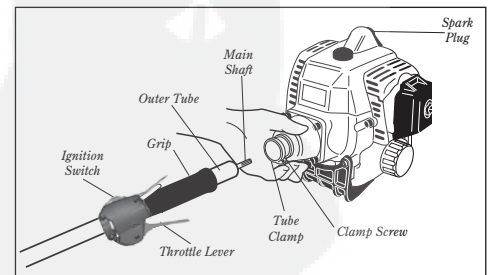

Connecting The Throttle Cable

Remove The Cylinder Cover

1. Remove the spark plug cap, then loosen the cylinder cover knob (about a dozen turns needed).

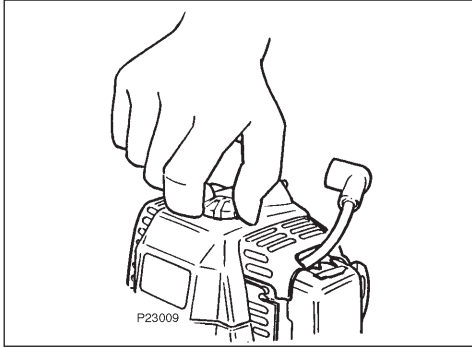

2. Lift the corner of the cylinder cover just below the muffler as shown, and lift off the cylinder cover.

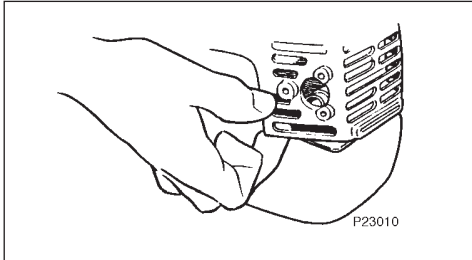

Connect The Throttle Cable

1. Loop the ribbed cable assembly to the top left side of the engine. Notice that the black ground wire (with a ring fitting on the end) is located between the two cable adjuster nuts as shown below.

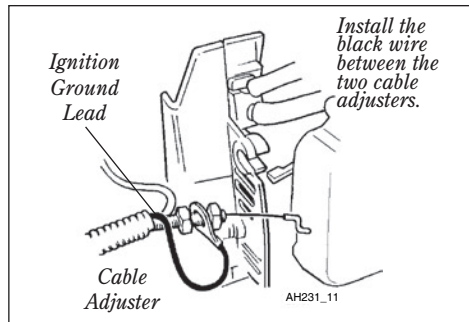

2. Connect the S-shaped end of the throttle cable to the throttle lever on top of the carburetor as shown below.

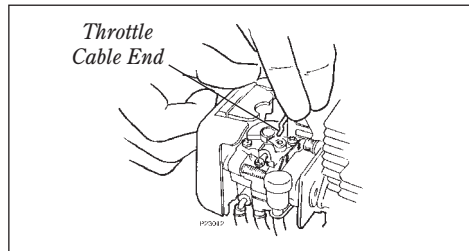

3. Turn the cable adjuster nuts sufficiently for the throttle cable to fit in the notch on the fan cover. Make sure the ignition ground lead is located on the rearward side of the notch. Then, connect the male fitting of the black ignition wire into the female fitting of the red wire attached to the engine.

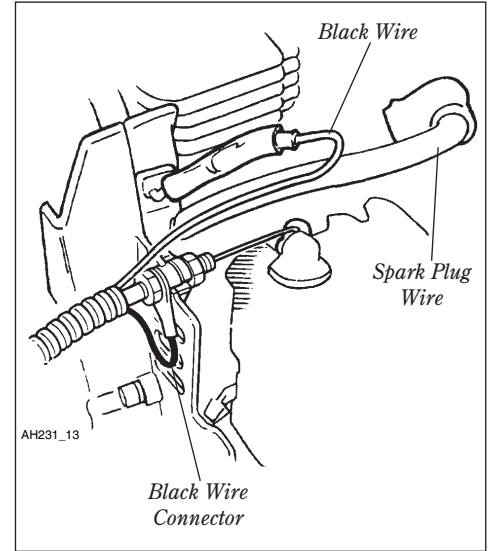

Adjusting the Throttle Cable

1. Loosen the two 10 mm throttle cable nuts at the fan cover as shown below.

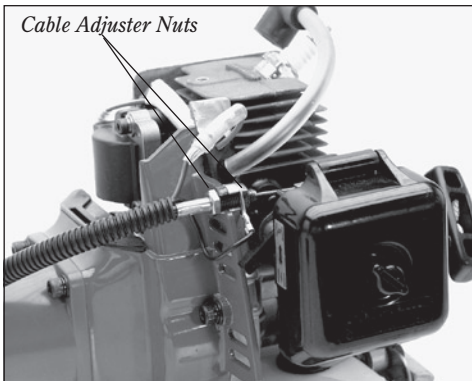

2. Adjust the throttle cable nuts until you achieve a free play on the throttle trigger of about 6 mm.

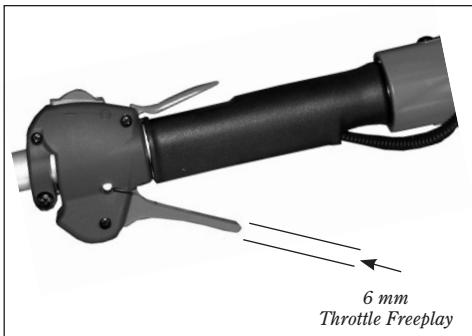

IMPORTANT!

Make sure the stop switch wires do not interfere with throttle functions. Reposition wires if necessary.

3. When 6 mm free play is achieved, tighten the two 10mm throttle cable nuts. When the throttle cable is correctly adjusted, and the throttle trigger is fully depressed (full throttle), the throttle will contact the stop on the throttle body.

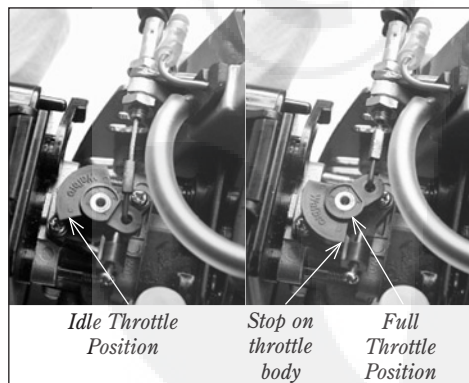

NOTE:

Put some Never-Seez™ or equivalent on the cylinder cover knob for easier removal.

4. Replace the cylinder cover.
5. Replace the spark plug cap.

Assembly Tube Sections

1. Place the powerhead/lower tube assembly and the upper tube assembly on a clean, flat surface so that both assemblies fit end to end. The powerhead/lower tube assembly should be facing up, and the lower tube assembly should be positioned with the locking hole in the tube end facing up.

CAUTION!

Keep the open ends of the tubes clean and free of debris!

2. Slip off the protective covers from the ends of both tubes, and loosen the coupler screw knob.
3. Insert the upper tube assembly into the coupler, arrow on the upper tube decal facing up, until the line of the decal is flush with the end of the coupler. Rock the upper tube back and forth until you are sure the latch snaps in place by the coupler lock.
4. When the two tube halves are locked together, press down on the spring-loaded latch protector and tighten the coupler screw.

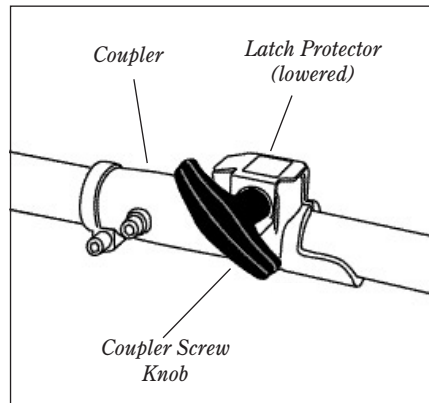
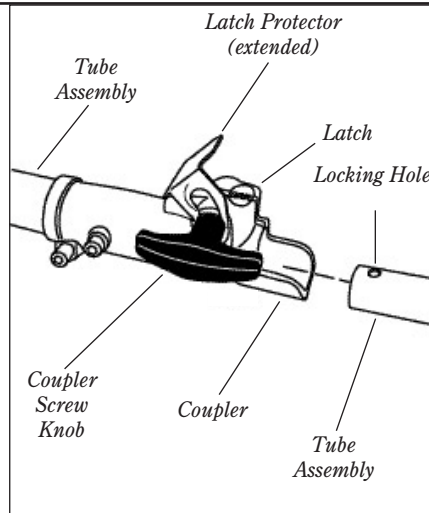

Disassembling The Pole Sections

1. With the pole pruner on a clean, flat surface, loosen the coupler screw. The spring-loaded coupler protector should pop up.
2. Press down on the latch with your finger or thumb. This releases the coupler lock.

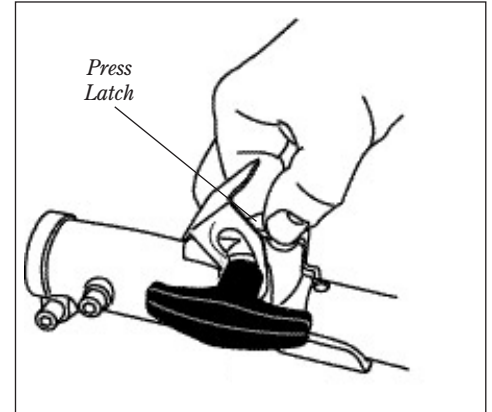

3. Pull the upper tube assembly out of the coupler.

Installing and Adjusting the Bar and Chain

Installing The Chain



WARNING!

Never attempt to install, replace, or adjust the chain with the engine running.



WARNING!

The saw chain is very sharp. Wear gloves to protect your hands when handling.

NOTE:

For longest chain life, let new or replacement chain loops soak in oil overnight before installation.

1. Using the small end of the plug wrench, remove the sprocket cover nut (turn counterclockwise to remove) and remove the sprocket cover.

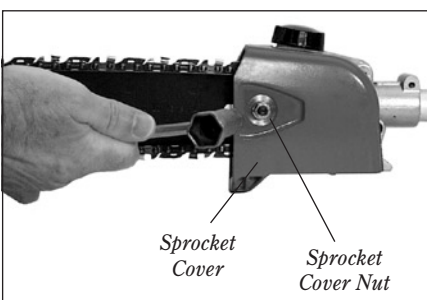

CAUTION!

Failure to align the guide bar and chain tensioning pin can cause serious damage to the sprocket cover, guide bar, chain tensioning pin and cutting head assembly.

2. Place the guide bar over the guide bar adjustment stud on the cutting head assembly. Align the chain tensioning pin with the hole in the guide bar.

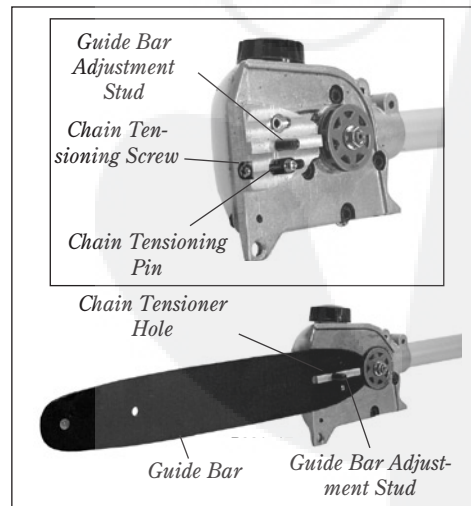

3. Install the chain loop over the drive links within the guide bar groove, and then align the chain over the drive sprocket. Verify that the cutters are properly oriented as shown. If chain installation is difficult or if the chain appears too tight, refer to the section "Adjusting the Chain" on the next page.



WARNING!

Never operate the pole pruner without the sprocket cover installed.

4. Install the sprocket cover over the bar stud. Using finger-pressure only, install the sprocket cover nut.
5. Refer to the next page for chain adjusting procedures.

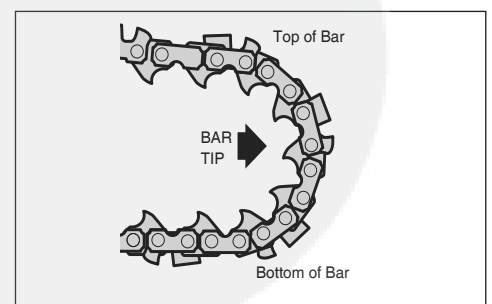

Adjusting the Chain



WARNING!

Never attempt to install, replace, or adjust the chain with the engine running.



WARNING!

The saw chain is very sharp. Wear gloves to protect your hands when handling.

CAUTION!

A loose chain can jump off the guide bar causing damage to the chain and associated equipment. Always make sure the chain is properly adjusted; check more often when you are breaking in a new chain.

IMPORTANT!

Proper chain adjustment is essential for maximum performance, long chain life, and operator safety. Always inspect chain tension before operating the pole pruner.

1. Place the pole pruner on a clean, flat surface. (For readjustment during operation, shut down the engine, then allow the guide bar and chain to cool before proceeding with the adjustment procedure).
2. Loosen the sprocket cover nut with a plug wrench.

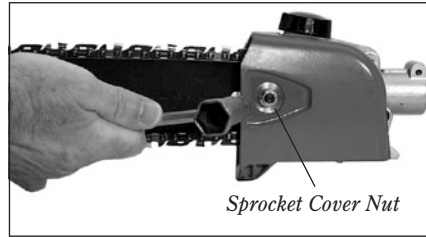

3. Lift the nose of the guide bar while turning the chain tensioning screw.

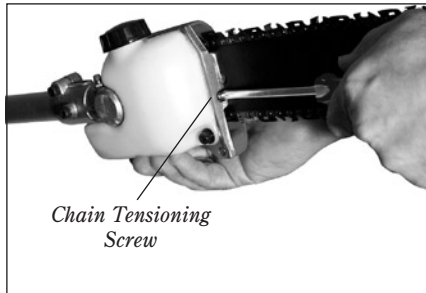

- clockwise to tighten the chain
- counter clockwise to loosen the chain.

4. Pull the chain by hand along the top of the guide bar several times from the engine to the bar's tip. The chain should feel snug but still pull freely.

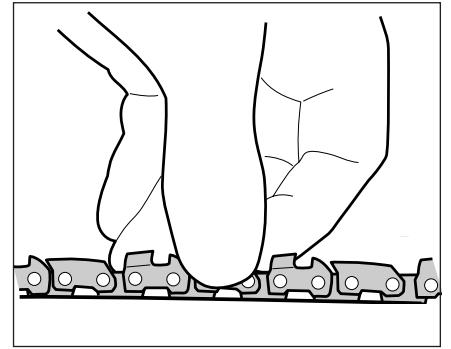

5. Tighten the sprocket cover nut securely while lifting the tip of the guide bar.
6. Inspect the chain for correct adjustment (more frequently with a new chain). The chain should feel snug but still pull freely.

Chain Oiler



WARNING!

Never fill the oil reservoir nor adjust the oiler with the engine running.

IMPORTANT!

The service life of the chain and guide bar is affected by the quality of the lubricant. Using superior lubricant such as Shindaiwa Bar and Chain Oil will help ensure a long service life. For cold weather operation, mix bar and chain oil with an equal part of kerosene.

Filling The Oil Reservoir

NOTE:

The oil reservoir has a capacity sufficient to provide about 40 minutes of cutting time (when set to deliver the minimum flow rate, or about as long as you'll get from a tank of fuel).

1. Place the pole pruner on a clean, flat surface with the oil filler cap facing up. Wipe off any debris from the oil cap and from around the oil filler neck.

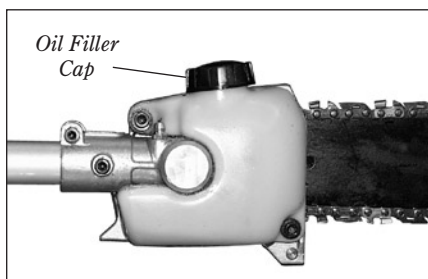

2. Remove the oil filler cap and fill the reservoir with bar and chain oil, then replace the cap.
3. Wipe up spilled oil from the unit before restarting the pole pruner.

Adjusting Oil Flow Rate

CAUTION!

An increase in bar oil flow rate will speed oil consumption, requiring more frequent checks on the oil reservoir. To ensure sufficient lubrication, it may be necessary to check the oil level more frequently than at fuel tank refills.

The guide bar and chain are lubricated automatically by a pump that operates whenever the chain rotates. The pump is set at the factory to deliver a minimum flow rate, but it can be adjusted in the field. A temporary increase in oil flow is often desirable when cutting materials such as hardwood or wood with a lot of pitch.

Adjust the pump as follows:

1. Stop the engine and make sure the stop switch is in the OFF position.
2. Place the unit on its side with the oil reservoir up.

CAUTION!

The oil flow adjusting screw must be pressed in slightly in order to turn. Failure to do so could damage the pump and screw.

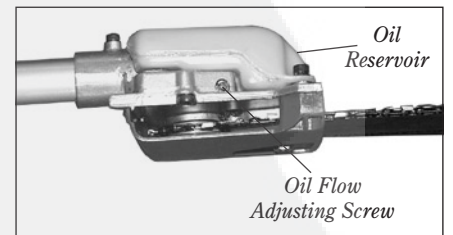

3. With a screwdriver, push in on the oil flow rate adjusting screw and turn in the desired direction (there are three incremental settings):
 - clockwise—decrease lubrication.
 - counter clockwise—increase lubrication.

Mixing Fuel



WARNING!

Minimize the risk of fire, burns, and personal injury!

- **STOP** engine before refueling.
- **ALWAYS** allow the engine to cool before refueling
- **ALWAYS** open the fuel cap slowly to allow any pressure build-up in the tank to release fuel vapor slowly.
- **ALWAYS** transport and store fuels in an approved container.
- Avoid overfilling and wipe-up all spilled fuel. Move the engine at least 3 meters from the fueling point, storage area, and other readily flammable materials before restarting.
- **ALWAYS** inspect the unit for fuel leaks before each use. During each refill, make sure there are no fuel leaks around the fuel cap and/or tank. If a fuel leak is evident, stop using the unit immediately. Fuel leaks must be repaired before using the unit.

- **Never** smoke or light any fires near the engine or fuel source.
- **NEVER** place any flammable material near the engine or muffler.
- **NEVER** operate the engine without the muffler in good working condition.

CAUTION!

This engine is designed to operate on a 50:1 mixture consisting of unleaded gasoline and a premium 2-cycle mixing oil only. Use of Non-approved mixing oils can lead to excessive maintenance costs and/or engine damage.

IMPORTANT!

Mix only enough fuel for your immediate needs! If fuel must be stored longer than 30-days, it should first be treated with a stabilizer such as StaBil™ or equivalent product!

CAUTION!

Never attempt to mix fuel in the unit's fuel tank. Always mix all fuels in a clean approved container.

CAUTION!

Some gasolines contain alcohol as an oxygenate! Oxygenated fuels may cause increased operating temperatures. Under certain conditions, alcohol-based fuels may also reduce the lubricating qualities of some mixing oils. Never use any fuel containing more than 10% alcohol by volume! Generic oils and some outboard motor oils may not be intended for use in high-performance air cooled 2-cycle engines, and should never be used in your Shindaiwa engine!

1. Use only fresh, clean unleaded gasoline with a pump octane rating of 87 or higher.
2. Mixing fuel with a Premium 2-cycle mixing oil designed for use with high-performance 2-cycle air-cooled engines.
3. Refer to the following examples of 50:1 fuel to oil mix quantities:

Gasoline liters	2-cycle mixing oil milliliters
2.5 l	50 ml
5 l	100 ml
10 l	200 ml
20 l	400 ml

Filling The Fuel Tank

IMPORTANT!

Mix only enough fuel for your immediate needs! If fuel must be stored longer than 30-days, it should first be treated with a stabilizer such as StaBil™ or equivalent product!

CAUTION!

Never attempt to mix fuel in the unit's fuel tank. Always mix all fuels in a clean approved container.

1. Place the pruner on a flat, level surface, and wipe any debris from around the fuel cap.
2. Remove the fuel cap.
3. Fill the tank with clean, fresh fuel.
4. Replace the cap, and wipe away any spilled fuel before starting the blower engine.

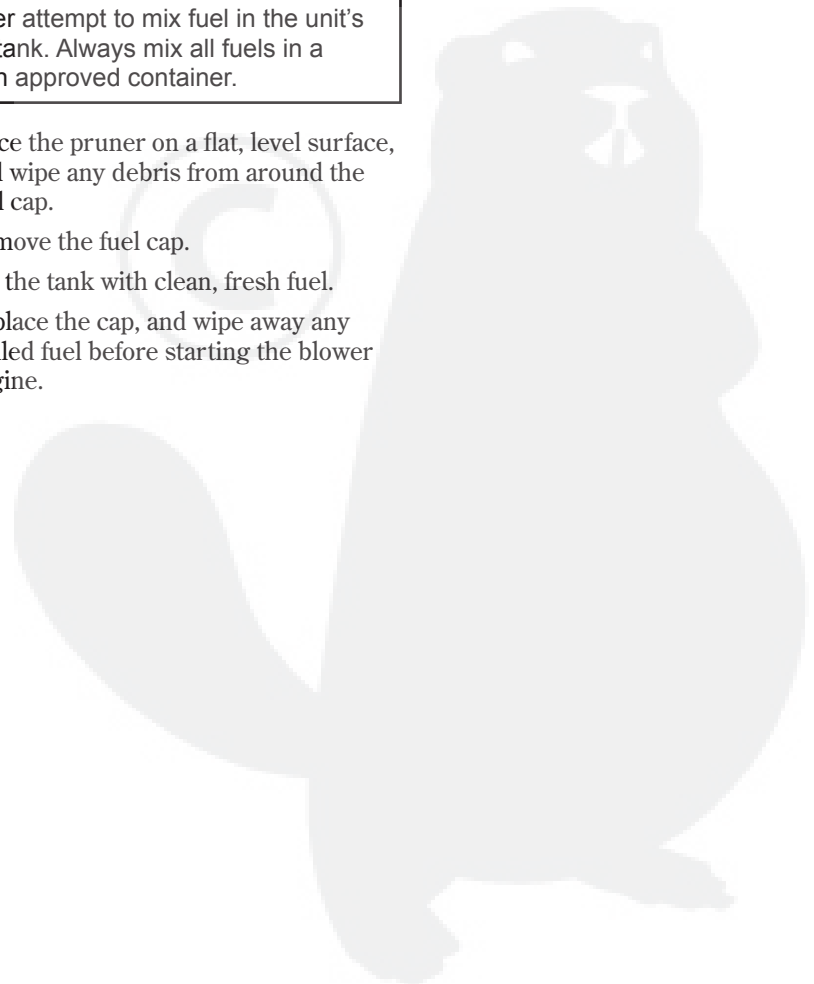

Starting the Engine

IMPORTANT!

Engine ignition is controlled by a two position switch mounted on the throttle housing labeled, "I" for ON or START and "O" for OFF or STOP.

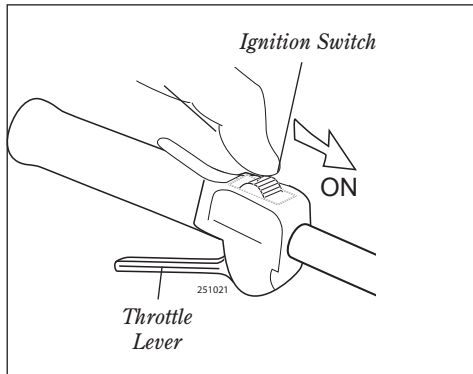

1. Slide the ignition switch to the "ON" position.

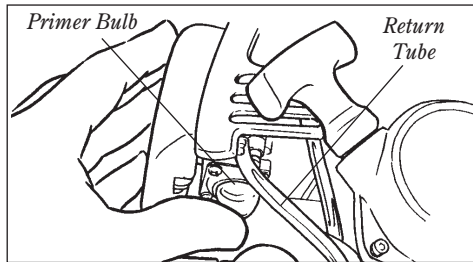

2. Press the primer bulb until fuel can be seen flowing in the transparent return tube.

IMPORTANT!

The primer system only pushes fuel through the carburetor. Repeatedly pressing the primer bulb will not flood the engine with fuel.

3. Set the choke lever to the CLOSED position if engine is cold.

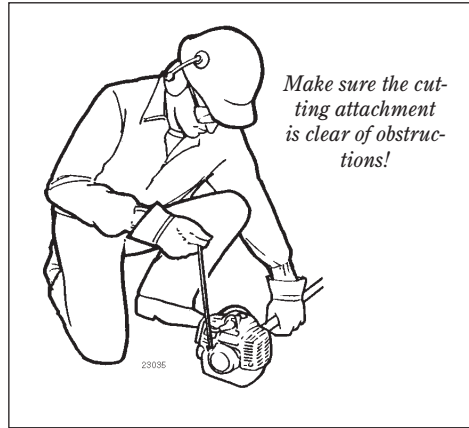
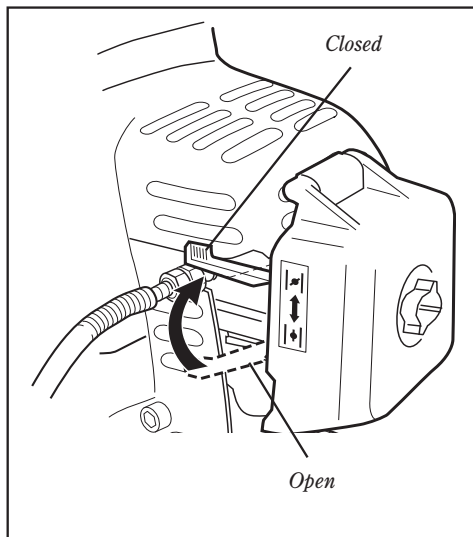

4. While holding the outer tube firmly with left hand. Use your other hand to slowly pull the recoil starter handle until resistance is felt, then pull quickly to start the engine.

CAUTION!

Do not pull the recoil starter to the end of the rope travel. Pulling the recoil starter to the end of the rope travel can damage the starter.

WARNING!

The cutting blades may move when the engine is started. Keep away from the cutter assembly while starting the engine.

5. When the engine starts, slowly move the choke lever to the "OPEN" position. (If the engine stops after the initial start, close the choke and restart.)

IMPORTANT!

If the engine fails to start after several attempts with the choke in the closed position, the engine may be flooded with fuel. If flooding is suspected, move the choke lever to the open position and repeatedly pull the recoil starter to remove excess fuel and start the engine. If the engine still fails to start, refer to the troubleshooting section of this manual.

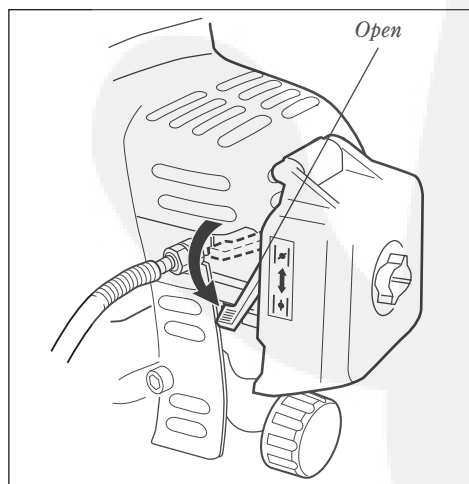

WARNING!

Never start the engine from the operating position.

When the Engine Starts...

- After the engine starts, allow the engine to warm up at idle 2 or 3 minutes before operating the unit.
- After the engine is warm, pick up the unit and clip on the shoulder strap if so equipped.
- Advancing the throttle makes the cutting attachment turn faster; releasing the throttle permits the attachment to stop turning. If the cutting attachment continues to rotate when the engine returns to idle, carburetor idle speed should be adjusted (see "Adjusting The Engine Idle" on the next page).

Stopping the Engine



WARNING!

The cutter attachment can continue moving after the engine is stopped!

1. Cool the engine by allowing it to idle for two or three minutes.
2. Slide the ignition switch to the "O" or STOP position.

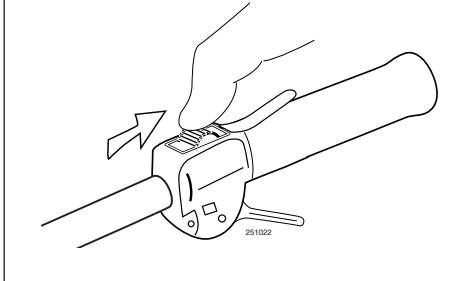

Adjusting The Engine Idle



WARNING!

The cutter attachment must never rotate at engine idle speed. If the idle speed cannot be adjusted by the procedures described here, return the pruner to your Shindaiwa dealer for inspection.

NOTE:

The mixture of the carburetor on this unit cannot be adjusted.

The engine must return to idle speed whenever the throttle trigger is released. Idle speed is adjustable and must be set low enough to permit the engine clutch to disengage the cutter attachment when throttle trigger is released.

Check and Adjust Idle Speed

1. Start the engine and allow it to idle two or three minutes, or until it warms up.
2. If the cutter attachment rotates at engine idle, reduce idle speed by turning the idle adjusting screw counter-clockwise as necessary.

IMPORTANT!

Use a tachometer, if one is available, to set engine idle. Standard idle speed is: 2,750 (± 250) min⁻¹.

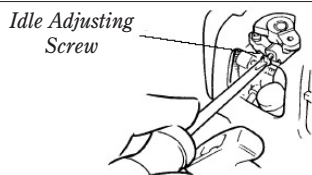

3. If the engine is stalling and won't idle, increase idle speed by turning the idle adjustment screw clockwise.

Attaching The Shoulder Strap

To Wear the Shoulder Strap

1. Hook the strap hook to the hanger on the outer tube.
2. Wear the shoulder strap so that the hook stays at your right hand side.
3. Adjust the length of the shoulder strap so that you can hold and operate the machine comfortably.

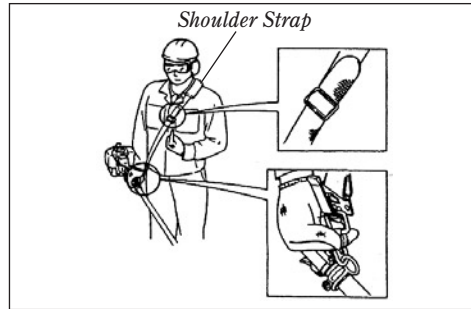

Emergency Release

In case of emergency, strongly pull the white tab at the hook. The machine will be released from the strap.

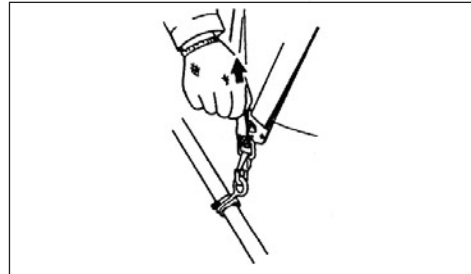

Using The Pole Pruner

This machine is designed especially for cutting branches.

Never use this machine for any other purposes. Never try to cut stones, metals, plastics, or any other hard objects.

Using for other purposes than cutting branches may damage the machine or cause serious injury.

Preparations

- Wear suitable protective clothing and equipment - see section "Safety precautions".
- Choose the best work position for safety against falling objects such as branches.
- Start the engine.
- Put on the strap.

Never stand directly underneath the branch you are cutting - be aware of falling branches. Note that a branch may spring back at you after it hits the ground.

Cutting Sequence

To allow branches to fall freely, always cut the bottom branches first. Prune heavy branches (large in diameter) in several controllable pieces.

Working Position

Hold the control handle with your right hand and the shaft with your left hand. Your left arm should be extended to the most comfortable position.

The shaft should always be held at an angle of 60° or less.

Standard Cut:

The most convenient working position is a tool angle of 60°, but any other angle may be used to suit the situation.

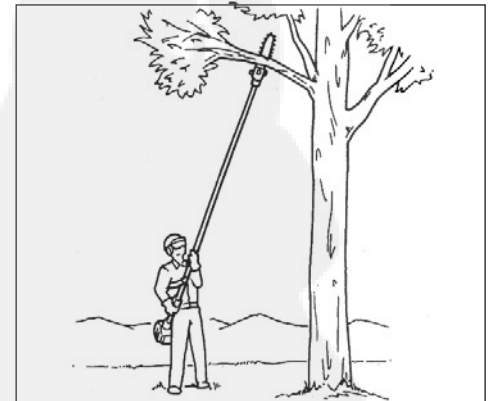

Using The Pole Pruner

(Continued)

Cutting Above Obstacles:

Thanks to the unit's long reach it is possible to prune branches that are overhanging obstacles such as rivers or lakes. The tool angle in this case depends on the position of the branch.

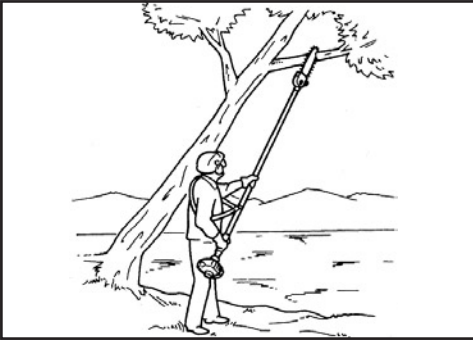

Cutting On A Work Platform:

The unit's long reach enables cutting to be performed next to the trunk without the risk of the work platform damaging other branches. Tool angle in this case depends on the position of the branch.

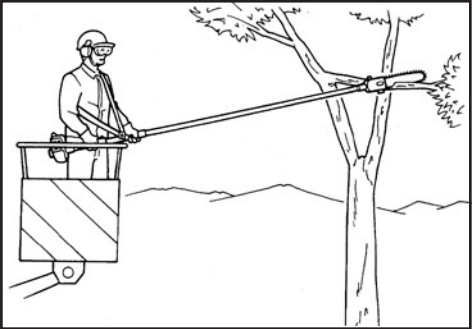

Relieving Cut:

To avoid tearing the bark, kickback or pinching the bar when pruning thick branches, always start by performing a relieving cut (1) on the underside of the branch.

To do this, apply the cutting attachment and pull it across the bottom of the branch as far as the bar nose. Perform the cross-cut (2).

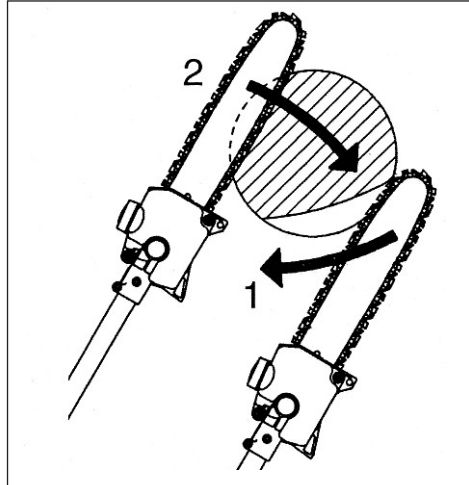

Flush-cutting Thick Branches:

If branch diameter is more than 10 cm, first perform undercut (3) and cross-cut at a distance (A) of about 25 cm from the final cut. Then carry-out the flush-cut (4), starting with a relieving cut and finishing with a cross-cut.

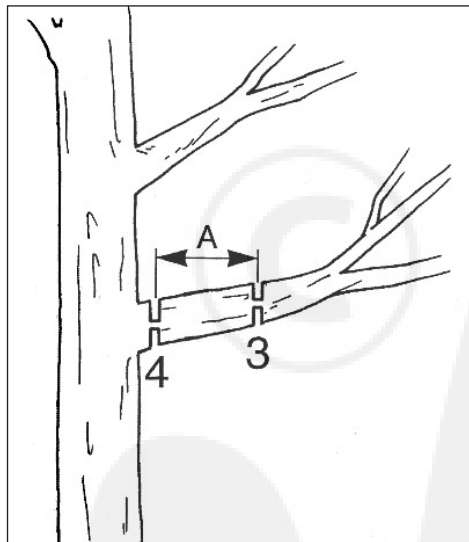

General Maintenance



WARNING!

Before performing any maintenance, repair, or cleaning work on the unit, make sure the engine and cutting attachment are completely stopped. Disconnect the spark plug wire before performing service or maintenance work.



WARNING!

Non-standard accessories, cutting attachment, or replacement parts may not operate properly with your unit and may cause damage and lead to personal injury.

Daily Maintenance

Prior to each work day, perform the following:

- Remove all dirt and debris from the engine, check the cooling fins and air cleaner for clogging, and clean as necessary.

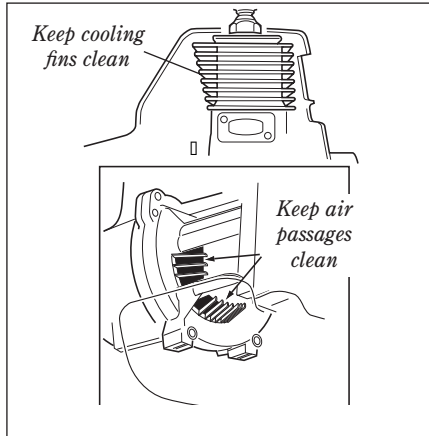

- Carefully remove any accumulations of dirt or debris from the muffler and fuel tank. Check cooling air intake area at base of crankcase. Remove all debris. Dirt build-up in these areas can lead to engine overheating, fire, or premature wear.



WARNING!

Always wear gloves when working around the cutter assembly.

- Clean any debris or dirt from the cutting attachment. Check the bar and chain for damage or incorrect adjustment.
- Check for loose or missing screws or components. Make sure the cutter attachment is securely fastened.
- Check the entire unit for leaking fuel or grease.
- Make sure nuts, bolts, and screws (except carburetor idle speed adjusting screws) are tight.

Muffler



WARNING!

Operating the engine without a muffler or with a muffler that is damaged or improperly installed can increase engine noise sufficiently to cause hearing loss.

This unit must never be operated with a faulty or missing muffler. Make sure the muffler is well secured and in good condition. A worn or damaged muffler is a fire hazard and may also cause hearing loss.

Spark Plug

Keep the spark plug and wire connections tight and clean.

10-Hour Maintenance

Every 10 hours of operation (more frequently in dusty or dirty conditions):

Remove the air cleaner element from the air cleaner housing and clean it thoroughly with soap and water. Let it dry before reinstalling the element.

CAUTION!

Do not operate the unit if the air cleaner or element is damaged, or if the element is wet.

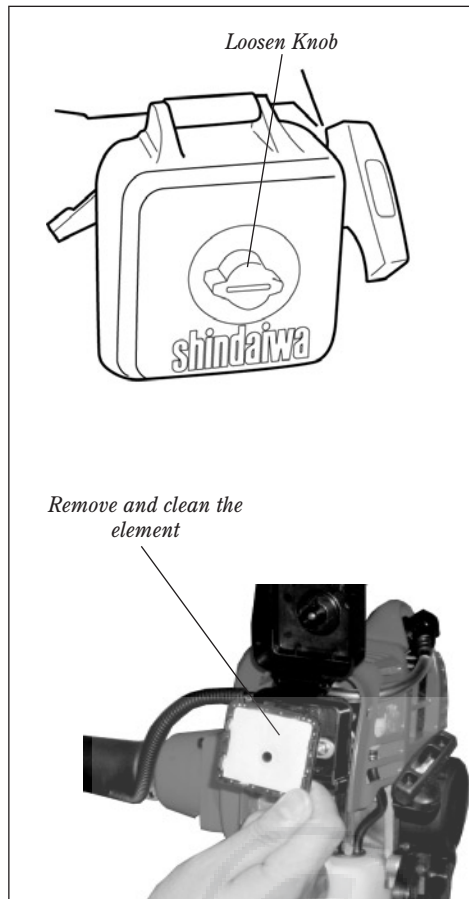

10/15-Hour Maintenance

Every 10 to 15 hours of operation: Remove and clean the spark plug. Adjust the spark plug electrode gap to 0.6 mm. If the plug must be replaced, use only a NGK BMR6A.

CAUTION!

Before removing the spark plug, clean the area around the plug to prevent dirt and debris from getting into the engine's internal parts

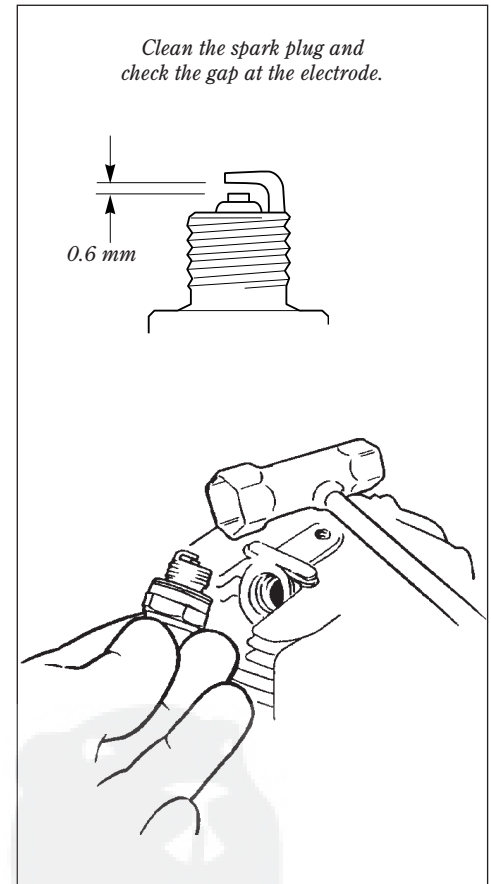

CAUTION!

Incorrect spark plug installation can result in serious engine damage.

50-hour Maintenance

Every 50 hours of operation

(more frequently in dusty or dirty conditions):

- Remove and clean the cylinder cover and clean dirt and debris from the cylinder cooling fins.
- Remove the sprocket cover and inspect the sprocket for excessive dirt, debris, or wear. Remove the guide bar and clean out the guide bar groove. If the sprocket is excessively worn, replace it with a new one.

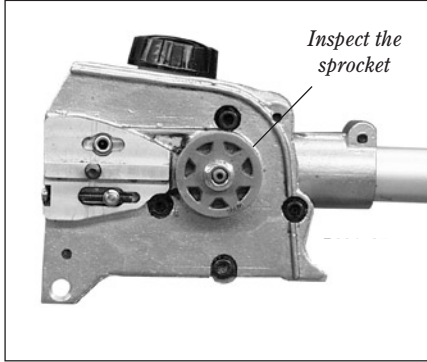

- **Lubricate the gearcase.** To perform this operation, first remove the gearcase from the upper outer tube as follows.

CAUTION!

Do not remove the D-washer from the gearcase clamp! The D-washer prevents damage from overtightening the tube clamp screw.

- loosen the gearcase clamp bolt.
- remove the index bolt from the gearcase.
- slide the gearcase out of the tube.

Using a lever-type grease gun, pump lithium-base grease (about 10 grams) into the grease fitting until you see old grease being purged from the gearcase, this can be seen in the outer tube cavity at the input end of the gearcase. Clean up excess grease, then reassemble the gearcase onto the outer tube.

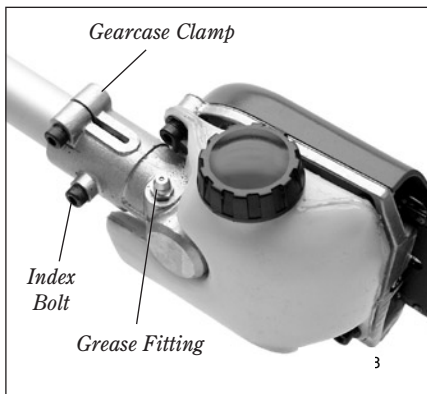

CAUTION!

Make sure you do not pierce the fuel line with the end of the hooked wire. The line is delicate and can be damaged easily.

- Use a hooked wire to extract the fuel filter from inside the fuel tank. Inspect the fuel filter element for signs of contamination. Replace it with a new one if required. Before reinstalling the filter, inspect the fuel line. If you find damage or deterioration, remove the unit from service until it can be inspected by a Shindaiwa-trained service technician.

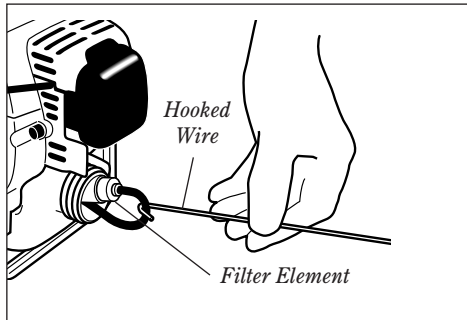

Long Term Storage

Whenever the unit will not be used for 30 days or longer, use the following procedures to prepare it for storage:

- Clean external parts thoroughly and apply a light coating of oil to all metal surfaces.
- Drain all the fuel from the fuel tank.

IMPORTANT!

All stored fuels should be stabilized with a fuel stabilizer such as STA-BIL™.

To remove the remaining fuel from the fuel lines and carburetor and with the fuel drained from the fuel tank:

1. Prime the primer bulb until no more fuel is passing through.
2. Start and run the engine until stops running.
3. Repeat steps 1 and 2 until the engine will no longer start.

CAUTION!

Gasoline stored in the carburetor for extended periods can cause hard starting, and could also lead to increased service and maintenance costs.

- Remove the spark plug and pour about 7 grams of 2-cycle mixing oil into the cylinder through the spark plug hole. Slowly pull the recoil starter 2 or 3 times so oil will evenly coat the interior of the engine. Reinstall the spark plug.
- Before storing the unit, repair or replace any worn or damaged parts.
- Remove the air cleaner element from the carburetor and clean it thoroughly with soap and water. Let dry and reassemble the element.
- Store the unit in a clean, dust-free area.

Sharpening the Chain

When the cutting edges of the blade become dull, they can be re-sharpened with a few strokes of a file.

In order to keep the blade in balance, all cutting edges must be sharpened equally. In addition, inspect the chain for correct adjustment (more frequently with a new chain). The chain should feel snug but still pull freely. Refer to page 10 for adjustment procedures.

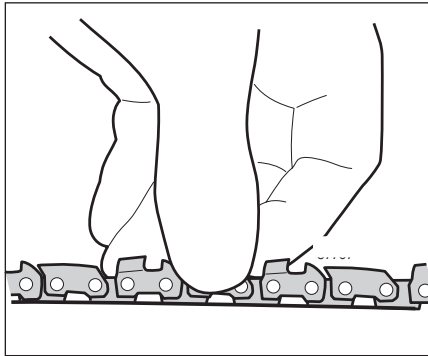

Sharpening Instructions

IMPORTANT!

File all cutters to the same angle and depth! Unequal filing may cause the saw to vibrate or cut erratically!

- Using a 4.5 mm round file, sharpen all cutters to a 30° angle. Make sure that one fifth (20%) of the file's diameter is always held above the cutter's top plate.

NOTE:

For consistent filing angles, use a filing guide such as Oregon™ p/n 31692 or equivalent.

- After all cutters are sharpened, use a depth gauge joiner (Oregon™ p/n 106738 or equivalent) to measure the height of each depth gauge.
- As required, lower the depth gauges to a height of 0.6 mm. Use a flat file; (Oregon™ p/n 12211 or equivalent).
- After all depth gauges have been adjusted, use a flat file to round each depth gauge leading edge to its original curvature and angle.

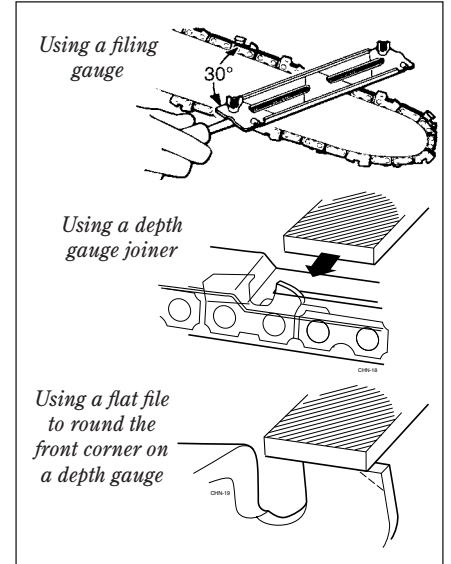

Correct Filing Technique

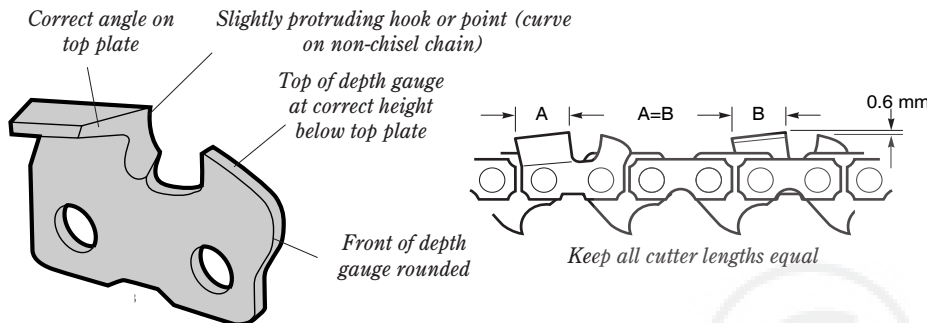

Filing Problems

<p>Top plate angle less than recommended</p> <p>Cause File held at less than recommended angle.</p> <p>Result Slow cutting. Requires extra effort to cut.</p> <p>Remedy File cutters to recommended angle.</p>	<p>Top plate angle more than recommended</p> <p>Cause File held at more than recommended angle.</p> <p>Result Cutting angle is very sharp but will dull fast. Cutting action rough and erratic.</p> <p>Remedy File cutters to recommended angle.</p>	<p>High depth gauge</p> <p>Cause Depth gauge never filed.</p> <p>Result Slow cutting. Must force chain to cut. Will cause excessive wear on the cutter heel.</p> <p>Remedy Lower gauges to recommended setting</p>
<p>Hook in side plate cutting edge</p> <p>Cause File held too low or the file was too small.</p> <p>Result Rough cutting. Chain grabs. Cutters dull quickly or won't hold a cutting edge.</p> <p>Remedy File cutters at recommended angle. Check file size.</p>	<p>Backslope on side plate cutting edge</p> <p>Cause File held too high or the file was too large.</p> <p>Result Cutters won't feed into wood. Slow cutting. Must force chain to cut. Causes excessive bottom wear.</p> <p>Remedy File cutters at recommended angle. Check file size.</p>	<p>Low depth gauge</p> <p>Cause Wrong gauge setting or no gauge used</p> <p>Result Rough cutting. Chain grabs. Saw won't pull chain through wood. Excessive wear on the cutter heel.</p> <p>Remedy If depth gauges are too low, the chain is no longer serviceable.</p>

Troubleshooting Guide

Engine Does Not Start

What To Check	Possible Cause	Remedy
Does the engine crank?	NO → Faulty recoil starter. Fluid in the crankcase. Internal damage.	Consult with an authorized servicing dealer.
YES ↓ Good compression?	NO → Loose spark plug. Excess wear on cylinder, piston, rings.	Tighten and retest. Consult with an authorized servicing dealer.
YES ↓ Does the tank contain fresh fuel of the proper grade?	NO → Fuel incorrect, stale, or contaminated; mixture incorrect.	Refill with clean fresh unleaded gasoline with a pump octane of 87 or higher, mixed with a Premium 2-cycle mixing oil at a 50:1 gasoline/oil ratio.
YES ↓ Is fuel visible and moving in the return line when priming?	NO → Check for clogged fuel filter and/or vent.	Replace fuel filter or vent as required. Restart.
YES ↓ Is there spark at the spark plug wire terminal?	NO → The ignition switch is in "O" (OFF) position. Shorted ignition system. Faulty ignition unit.	Move switch to "I" (ON) position and re-start. Consult with an authorized servicing dealer.
YES ↓ Check the spark plug.	<p>If the plug is wet, excess fuel may be in the cylinder.</p> <p>The plug is fouled or improperly gapped.</p> <p>The plug is damaged internally or of the wrong size.</p>	<p>Crank the engine with the plug removed, replace the plug, and re-start.</p> <p>Clean and re-gap the plug to 0.6 mm ; Re-start.</p> <p>Replace the plug with a NGK BMR6A or equivalent type spark plug of the correct heat range. Adjust the spark plug electrode gap to 0.6mm; Restart.</p>



Troubleshooting Guide (Continued)

Low Power Output

What To Check	Possible Cause	Remedy
Is the engine overheating?	Operator is overworking the unit.	Use a lower throttle setting.
	Carburetor mixture is too lean.	Consult with an authorized servicing dealer.
	Improper fuel ratio.	Refill with clean fresh unleaded gasoline with a pump octane of 87 or higher, mixed with a Premium 2-cycle mixing oil at a 50:1 gasoline/oil ratio.
	Fallen leaves or debris on intake cover.	Clean the intake cover.
	Fan, fan cover, cylinder fins dirty or damaged. Carbon deposits on the piston or in the muffler.	Clean, repair or replace as necessary. Consult with an authorized servicing dealer.
Engine is rough at all speeds. May also have black smoke and/or unburned fuel at the exhaust.	Clogged air filter.	Clean or replace the air filter.
	Loose or damaged spark plug.	Tighten or replace the plug with an NGK BMR6A or equivalent type spark plug of the correct heat range.
	Air leakage or clogged fuel line.	Repair or replace filter and/or fuel line.
	Water in the fuel.	Refill with fresh fuel/oil mixture. See Page 11.
	Piston seizure.	Consult with an authorized servicing dealer.
	Faulty carburetor and/or diaphragm.	Consult with an authorized servicing dealer.
Engine is knocking.	Overheating condition.	See above.
	Improper fuel.	Check fuel octane rating; check for presence of alcohol in the fuel. Refuel as necessary. See page 11.
	Carbon deposits in the combustion chamber.	Consult with an authorized servicing dealer.

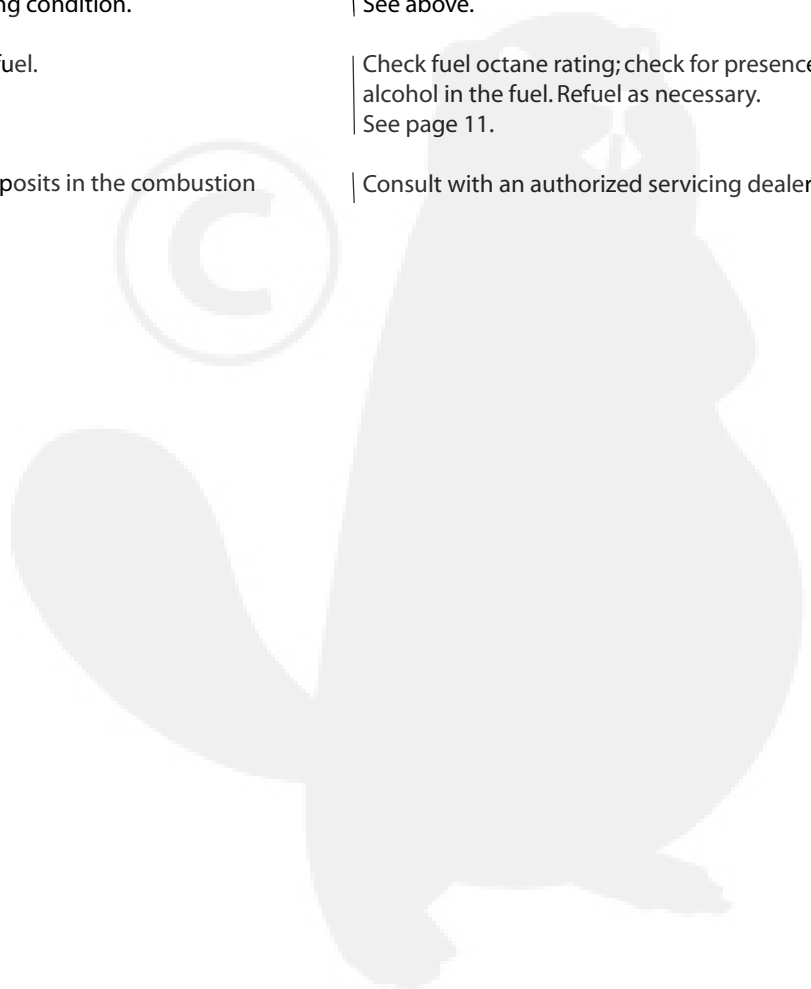

Troubleshooting Guide (Continued)

Additional Problems

Symptom	Possible Cause	Remedy
Poor acceleration.	<ul style="list-style-type: none"> Clogged air filter. Clogged fuel filter. Lean fuel/air mixture. Idle speed set too low. 	<ul style="list-style-type: none"> Clean or replace the air filter. Replace the fuel filter. Consult with an authorized servicing dealer. Adjust: 2,75 0 (± 250) min⁻¹
Engine stops abruptly.	<ul style="list-style-type: none"> Ignition switch turned off. Fuel tank empty. Clogged fuel filter. Water in the fuel. Shorted spark plug or loose terminal. Ignition failure. Piston seizure. 	<ul style="list-style-type: none"> Reset the switch and re-start. Refuel. See page 11. Replace filter. Drain; replace with clean fuel. See page 11. Clean or replace spark plug with a NGK BMR6A or equivalent type spark plug of the correct heat range. Consult with an authorized servicing dealer. Consult with an authorized servicing dealer.
Engine difficult to shut off.	<ul style="list-style-type: none"> Ground (stop) wire is disconnected, or switch is defective. Overheating due to incorrect spark plug. Overheated engine. 	<ul style="list-style-type: none"> Test and replace as required. Replace spark plug with a NGK BMR6A or equivalent spark plug of the correct heat range. Idle engine until cool.
Cutting attachment rotates at engine idle.	<ul style="list-style-type: none"> Engine idle too high. Broken clutch spring or worn clutch spring boss. Loose attachment holder. 	<ul style="list-style-type: none"> Set idle: 2,750 min⁻¹ (±250). Replace spring/shoes as required, check idle speed. Inspect and retighten holders securely.
Excessive Vibration	<ul style="list-style-type: none"> Warped or damaged attachment. Loose gearcase. Bent main shaft/worn or damaged bushings. 	<ul style="list-style-type: none"> Inspect and replace attachment as required. Tighten gearcase securely. Inspect and replace as necessary.
Attachment will not rotate.	<ul style="list-style-type: none"> Shaft not installed in powerhead or gearcase. Broken shaft. Damaged gearcase. 	<ul style="list-style-type: none"> Inspect and reinstalled as required. Return unit to dealer. Return unit to dealer.

DECLARATION OF CONFORMITY

We hereby declare the Shindaiwa Pole Pruner, Model P230 (P230/EC1).

meets the following respective requirements.

Council Directives:

89/336/EEC as amended
98/37/EC as amended
2000/14/EC as amended
2004/26/EC as amended

Standard taken:

EN 292 parts 1&2
ISO 11680-1
CISPR 12

Measured sound power level: 109dB(A)

Guaranteed sound power level: 111dB(A)

Technical documentation is kept by:

K. Maeda DIV. Manager
Engineering Research and Development DIV.

Shindaiwa Kogyo Co.,Ltd.

Head office : 6-2-11, Ozuka-Nishi, Asaminami-Ku,
Hiroshima, 731-3167, Japan

TEL:81-82-849-2003 , FAX:81-82-849-2482

13 December, 2004



T. Yoshitomi
DIV. Manager
Quality Assurance DIV.

Shindaiwa Kogyo Co.,Ltd.

Head office : 6-2-11, Ozuka-Nishi, Asaminami-Ku,
Hiroshima, 731-3167, Japan

TEL:81-82-849-2206 , FAX:81-82-849-2481





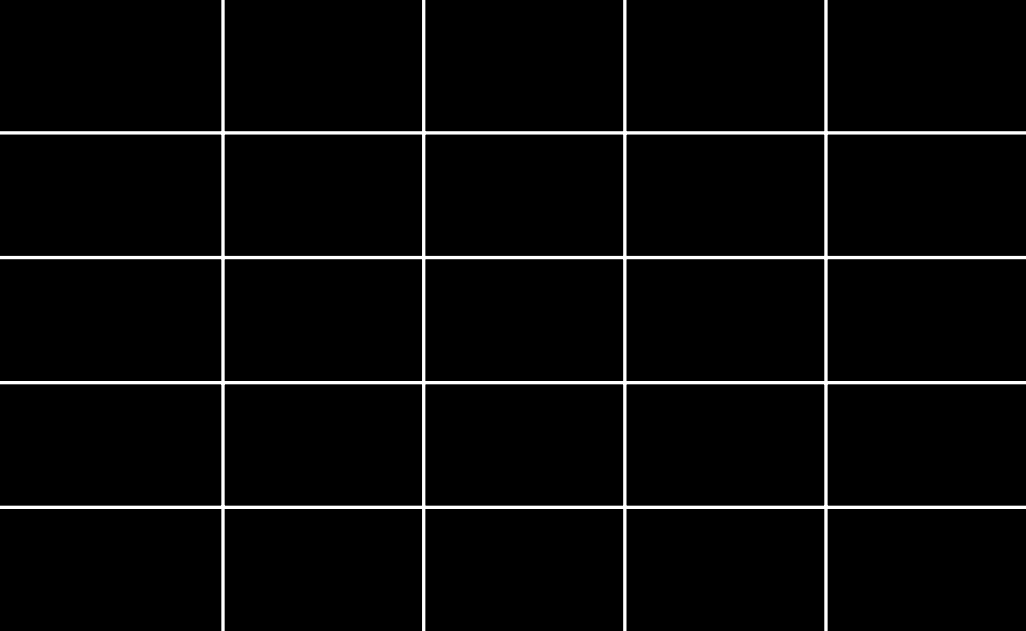

shindaiwa

Shindaiwa Inc.
11975 SW Herman Rd.
Tualatin, Oregon 97062
U.S.A.
Telephone: 503 692-3070
Fax: 503 692-6696
www.shindaiwa.com

Shindaiwa Kogyo Co., Ltd.
6-2-11, Ozuka-Nishi,
Asaminami-Ku, Hiroshima
731-3167, Japan
Telephone: 81-82-849-2220
Fax: 81-82-849-2481

© 2004 Shindaiwa, Inc.
Part Number 62889-94310
Revision 12/04

Shindaiwa is a registered trademark of Shindaiwa, Inc.
Specifications subject to change without notice.

