

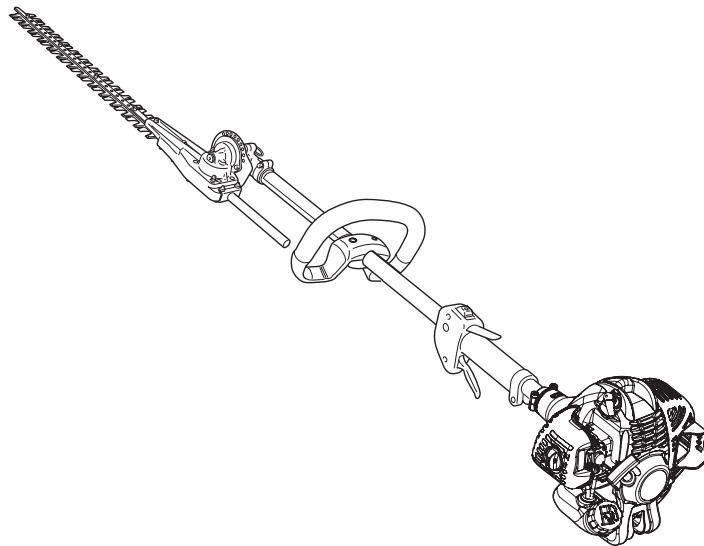

GB ENGLISH
(Original instructions)



OPERATOR'S MANUAL

HEDGE CLIPPER HCAS-235ES

 **WARNING**

**READ THE INSTRUCTIONS CAREFULLY AND FOLLOW THE
RULES FOR SAFE OPERATION.
FAILURE TO DO SO COULD RESULT IN SERIOUS INJURY.**



Important information

Please ensure that you read the operator's manual before using your product.

○ Intended use of this product

- ♦ ECHO Hedge Clipper are lightweight, high-performance, petrol engined units designed for hedge and shrub trimming.
- ♦ Do not use this unit for any purpose other than aforementioned.

○ Users of the product

- ♦ You should not use this product until you have read the operator's manual carefully and fully absorbed its content.
- ♦ This product should not be used by anyone who has failed to read the operator's manual properly, is suffering from a cold, tiredness or otherwise in poor physical condition, or children.
- ♦ Keep in mind that the operator or user is responsible for accidents or hazards occurring to other people or their property.

○ About your operator's manual

- ♦ This manual contains necessary information about the operation and maintenance of your product. Please read it carefully and absorb its contents.
- ♦ Always keep your manual in a place where it is readily accessible.
- ♦ If you have lost your manual or it is damaged and no longer readable, please purchase a new one from your ECHO DEALER.
- ♦ The units used in this manual are SI units (International System of Units). Figures in parentheses are reference values, and there may be a slight conversion error in some cases.

○ Loaning or assigning your product

- ♦ When loaning the product described in this manual to another party, ensure that the person borrowing and working with the product receives the operator's manual along with the product. If you assign your product to another party, please enclose the operator's manual with the product when handing it over.

○ Enquiries

- ♦ Please contact your ECHO DEALER for requests regarding information about your product, the purchase of consumables, repairs, and other such enquiries.

○ Notices

- ♦ The content of this manual may be changed without notice for the purpose of upgrades to the product. Some of the illustrations used may differ from the product itself in order to make the explanations clearer.
- ♦ This product requires the assembly of some parts.
- ♦ Please consult your ECHO DEALER if anything is unclear or of concern.

○ Feature of this model: "ES" START

- ♦ "ES" START generates enough revolving power to rotate crankshaft up to a speed to ignite the engine and bring almost no kickback. "ES" START makes engine start far easier than you ever expect.

Manufacturer

YAMABIKO CORPORATION

7-2 SUEHIROCHO 1-CHOME, OHME, TOKYO 198-8760, JAPAN

Authorized Representative in Europe

Atlantic Bridge Limited

Atlantic House, PO Box 4800, Earley, Reading RG5 4GB, United Kingdom

For safe use of your product.....	4
Warning notices	4
Other indicators	4
Symbols.....	4
Location in which the safety decal is attached.....	5
Handling fuel.....	6
Handling the engine.....	7
Handling the product	8
Packing list.....	12
Description.....	13
Before you start	14
Assembly	14
Adjusting Cutting Angle	15
Preparing the fuel	16
Engine operation.....	17
Starting the engine	17
Stopping the engine.....	18
Hedge and shrub trimming operation	19
Basic hedge trimming operation	19
Maintenance and care	20
Servicing guidelines.....	20
Maintenance and care	20
Storage	26
Long-term storage (30 days or more).....	26
Disposal procedure	27
Specifications.....	28
Declaration of conformity	29



For safe use of your product

Be careful to read this section before using your product.



○ The precautions described in this section contain important safety information. Please observe them carefully.

○ You must also read the precautions that appear in the body of the manual itself.

Text following a [diamond mark] mark describes the potential consequences of failing to observe the precaution.

Warning notices

Situations where there is a risk of physical injury to the operator and other people are indicated in this manual and on the product itself by the following warning notices. Always read and observe them carefully in order to ensure safe operation.

 DANGER	 WARNING	 CAUTION
This symbol accompanied by the word " DANGER " calls attentions to an act or a condition which will lead to serious personal injury or death of operators and bystanders.	This symbol accompanied by the word " WARNING " calls attentions to an act or a condition which can lead to serious personal injury or death of operators and bystanders.	" CAUTION " indicates a potentially hazardous situation which, if not avoided, may result in minor or moderate injury.







Other indicators

As well as warning notices, this manual uses the following explanatory symbols:









	Circle and slash symbol means whatever is shown is prohibited.	NOTE	This enclosed message provides tips for use, care and maintenance of the product.	IMPORTANT	Framed text featuring the word " IMPORTANT " contains important information about the use, checking, maintenance and storage of the product described in this manual.
---	--	-------------	---	------------------	--

Symbols

In this manual and on the product itself, a series of explanatory symbols is used. Please make sure that you fully understand what each symbol means.

Symbol form/shape	Symbol description/application	Symbol form/shape	Symbol description/application
	Carefully read the operator's manual		Petrol and oil mixture
	Wear eyes, ears and head protection		Purge bulb (Primer)
	Safety / Alert	L	Carburettor adjustment - Low speed mixture
	Finger severing	H	Carburettor adjustment - High speed mixture
	Emergency stop	T	Carburettor adjustment - Idle speed

For safe use of your product

Symbol form/shape	Symbol description/applica- tion	Symbol form/shape	Symbol description/applica- tion
	Do not use the product in plac- es with poor ventilation		Choke Control "Cold Start" Position (Choke Closed)
	Beware of fire		Choke Control "Run" Position (Choke Open)
	Beware of electric shocks		Environmental protection!
	Beware of high-temperature areas		Guaranteed sound power lev- el
	Engine start		

Location in which the safety decal is attached

- The safety decal shown below has been attached to the products described in this manual. Ensure that you understand what the decal means before using your product.
- If the decal becomes unreadable due to wear and tear or damage, or peels off and is lost, please purchase a replacement decal from your ECHO DEALER and attach it in the location shown in the illustrations below. Ensure that the decal is readable at all times.

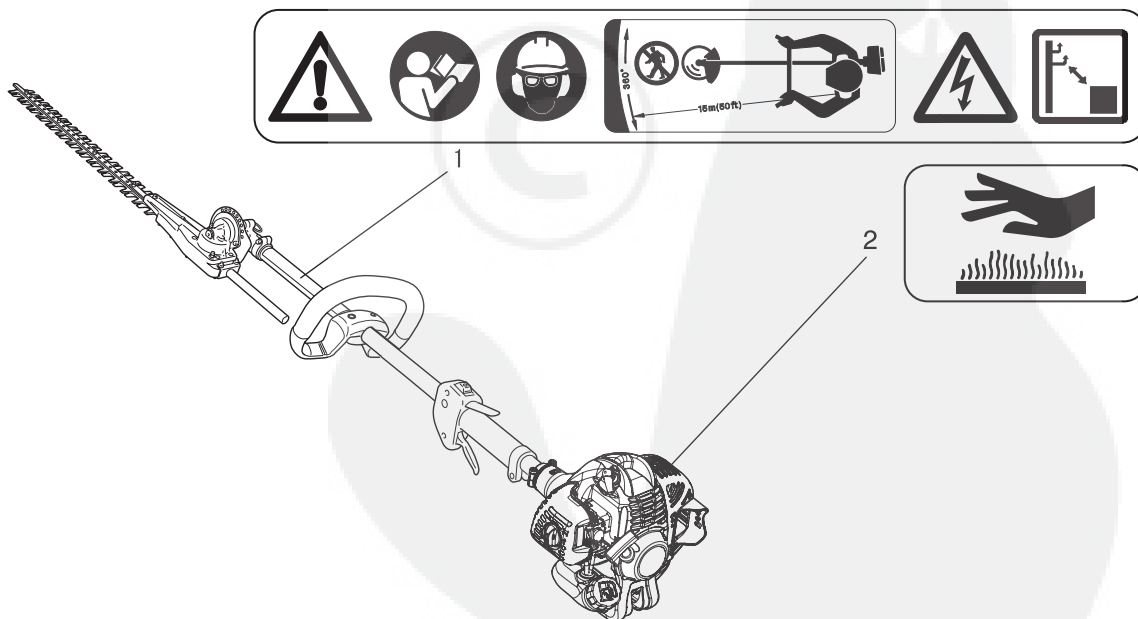

1. Safety decal (Part number 890617-12361)

2. Safety decal (Part number X505-002310)

For safe use of your product

Handling fuel

DANGER

Always keep well away from fire when refuelling

Fuel is highly inflammable and leads to a risk of fire if mishandled. Use extreme care when mixing, storing or handling or serious personal injury may result. Be careful to observe the following instructions.

- Do not smoke or hold a flame near when refuelling.
- Do not fuel up while the engine is hot or in operation.
- ◆ If you do so, the fuel could ignite and cause fire, leading to burns.



About the container and refuelling place

- Use an approved fuel container.
- Fuel tanks/cans may be under pressure. Always loosen fuel caps slowly allowing pressure to equalize.
- DO NOT fill fuel tanks indoors. ALWAYS fill fuel tanks outdoors over bare ground.

Fuel spills can cause fire

Observe the following precautions when refuelling:

- Do not add so much fuel that it reaches the mouth of the fuel tank. Keep the fuel within the prescribed level (up to the shoulder level of the fuel tank).
- Mop up any fuel that overflows or spills out due to over-filling.
- Tighten the fuel tank cap securely after refuelling.
- ◆ Fuel spills can cause fire and burns when ignited.

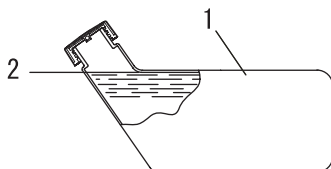

- 1. Fuel tank
- 2. Shoulder level

Do not start the engine in the area where you refueled

- You must not start the engine in the place where you carried out the refuelling. Move at least 3m from the place where you refueled before starting the engine.

- ◆ Fuel leaks that occur while refuelling can cause fire if ignited.

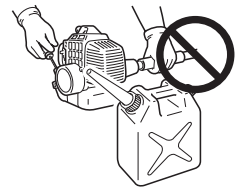

Fuel leaks cause fire

- After refuelling, always check that there are no leaks or discharges of fuel from the fuel pipe, fuel system grommets, or around the fuel tank cap.
- If you do find fuel leaks or discharges, stop using the product immediately and contact your ECHO DEALER to have it repaired.
- ◆ Any fuel leaks could cause fire.

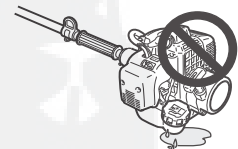

For safe use of your product

Handling the engine

WARNING

Starting the engine

Be particularly careful to observe the following precautions when starting the engine:

- Always ensure all handles and guards are fitted
- Check that none of the nuts and bolts are loose
- Check that there are no fuel leaks
- Check that the cutter blades is not damaged or excessively worn. If you find any abnormalities, do not use the product.
- Place the product in a flat, well ventilated place
- Leave plenty of space around the product and do not allow people or animals near it
- Remove obstructions, if any
- Make sure that the cutter blades is not touching the ground or any obstacles
- Start the engine with the throttle trigger in the idle speed position
- Hold the product firmly to the ground when starting the engine
- Do not start the engine holding the product in the air
- ◆ Failure to observe the precautions could cause an accident or injury, or even lead to a fatality.

Once the engine has started, check for abnormal vibrations and sounds

- Check that there are no abnormal vibrations or sounds once the engine starts. Do not use the product if there are abnormal vibrations or sounds. Contact your ECHO DEALER to have it repaired.
- ◆ Accidents involving parts that fall or shatter off can cause wounds or serious injury.

Do not touch high temperature or high voltage components while the product is running

Do not touch the following high temperature or high voltage components while the product is running or for some time after it stops.

- Silencer, spark plug, gear housing, and other high temperature components
- ◆ You could burn yourself if you touch a high temperature component.
- Spark plug, spark plug wire, and other high voltage components
- ◆ You could receive an electric shock if you touch a high voltage component while the product is running.



Put safety first in the case of fire or smoke

- If fire comes from the engine or smoke appears from any area other than the exhaust vent, first distance yourself from the product to ensure your physical safety.
- Use a shovel to throw sand or other such material on the fire to prevent it from spreading, or put it out with a fire extinguisher.
- ◆ A panicked reaction could result in the fire and other damage becoming more extensive.



Exhaust fumes are toxic

- The exhaust fumes from the engine contain toxic gases. Do not operate the product indoors or in a plastic greenhouse or in other ill ventilated places.
- ◆ The exhaust fumes could cause poisoning.



Turn off the engine when checking or maintaining the product

Observe the following precautions when checking and maintaining your product after use:

- Turn the engine off and do not attempt to check or maintain the product until the engine has cooled
- ◆ You could burn yourself.
- Remove the spark plug cap before performing checks and maintenance
- ◆ An accident could occur if the product starts unexpectedly.

Checking the spark plug

Observe the following precautions when checking the spark plug.

- If the electrodes or terminals are worn, or if there are cracks in the ceramics, replace them with new parts.
- The spark test (for checking whether the spark plug is sparking) must be carried out by your ECHO DEALER.
- The spark test must not be carried out in proximity of the spark plug hole.
- The spark test must not be performed in places where there are fuel spills or inflammable gases
- You must not touch the metal parts of the spark plug
- ◆ The spark plug could ignite a fire or give you an electric shock.



For safe use of your product

Handling the product General precautions

WARNING

Operator's manual

- Be careful to read the operator's manual properly before using your product in order to ensure correct operation.
- ◆ Failure to do so could lead to an accident or serious injury.



Do not use the product for anything other than its intended purpose

- You must not use the product for any purpose other than those described in the operator's manual.
- ◆ To do so could lead to an accident or serious injury.

Do not modify the product

- You must not modify the product.
- ◆ To do so could lead to an accident or serious injury. Any malfunction resulting from a modification to the product will not be covered by the manufacturer's warranty.

Do not use the product unless it has been checked and maintained

- You must not use the product unless it has been checked and maintained. Always ensure that the product is checked and maintained on a regular basis.
- ◆ Failure to do so could lead to an accident or serious injury.

Loaning or assigning your product

- When loaning your product to another party, ensure that the person borrowing the product receives the operator's manual along with it.
- If you assign your product to another party, please enclose the operator's manual with the product when handing it over.
- ◆ Failure to do so could lead to an accident or serious injury.

Being prepared in case of an injury

In the unlikely event of an accident or injury, please ensure that you are prepared.

- First aid kit
- Towels and wipes (to stop any bleeding)
- Whistle or mobile phone (for calling outside help)
- ◆ If you are unable to perform first aid or call for outside help, the injury could worsen.

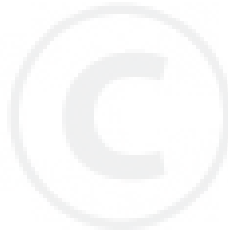
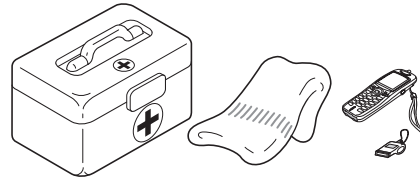

For safe use of your product

Precautions for use

DANGER

Always stop the engine when a blades jam occurs

- Do not attempt to remove an object causing a blades jam if the engine is running.
- ◆ Physical injury can occur if a blades jam is removed and the blades starts moving.

WARNING

Users of the product

The product should not be used by:

- people who are tired
- people who have taken alcohol
- people who are on medication
- people who are pregnant
- people who are in poor physical condition
- people who have not read the operator's manual
- children
- ◆ Failure to observe these instructions could lead to an accident.



Environment of use and operation

- Do not use the product in places where there is no sure foothold, such as on steep slopes or after rainfall, as such places are slippery and dangerous.
- Maintain footing and balance at all times. Do not stand on slippery, uneven or unstable surfaces. Do not work in odd positions or on ladders. Do not over reach.
- Do not operate the product at night or in dark places with poor visibility.
- Heavy protective clothing can increase operator fatigue which may lead to heat stroke. Schedule heavy work for early morning or late afternoon hours when temperatures are cooler.
- ◆ A serious injury could result if you fall or slip, or fail to operate the product correctly.

Turn off the engine when moving around

When moving around in the situations described below, turn off the engine and ensure that the cutter blades has stopped moving, then fit the blade cover and position the silencer away from yourself.

- Moving to the place where you are working
- Moving to another area while you are working
- Leaving the place where you have been working
- ◆ Failure to observe these precautions could cause burns or serious injury.
- When transporting the product by car, empty the fuel tank, fit the blade cover, and secure the product firmly in place to prevent it from moving around.
- ◆ Travelling by car with fuel in the fuel tank could lead to a fire.

Vibration and cold

It is believed that a condition called Raynaud's Phenomenon which affects the fingers of certain individuals may be brought about by exposure to vibration and cold. Exposure to vibration and cold may cause tingling and burning, followed by loss of colour and numbness in the fingers. The following precautions are strongly recommended because the minimum exposure which might trigger the ailment is unknown.

- Keep your body warm, especially the head and neck, feet and ankles, and hands and wrists.
- Maintain good blood circulation by performing vigorous arm exercises during frequent work breaks, and also by not smoking.
- Limit the number of hours of operation.
Try to fill each day with jobs where operating the hedge trimmer or other hand-held power equipment is not required.
- If you experience discomfort redness and swelling of the fingers, followed by whitening and loss of feeling, consult your physician before exposing yourself further to cold and vibration.
- ◆ Failure to observe these instructions could result in damage to your health.

Repetitive stress injuries

It is believed that over-using the muscles and tendons of the fingers, hands, arms and shoulders may cause soreness, swelling, numbness, weakness and extreme pain to the areas just mentioned. Certain repetitive hand activities may put you at a high risk for developing a repetitive stress injury (RSI).

To reduce the risk of RSI, do the following:

- Avoid using your wrist in a bent, extended or twisted position.
- Take periodic breaks to minimize repetition and rest your hands. Reduce the speed and force in which you do the repetitive movement.
- Do exercises to strengthen hand and arm muscles.
- See a doctor if you feel tingling, numbness or pain in your fingers, hands, wrists or arms. The sooner RSI is diagnosed, the more likely permanent nerve and muscle damage can be prevented.
- ◆ Failure to observe these instructions could result in damage to your health.

For safe use of your product

WARNING

Remove foreign objects and obstructions before working with the product

- Inspect area that the product will be used in. Remove stones, metal objects and any other object that could jam or damage the product.
- ◆ An accident or serious injury can occur if foreign objects throw the cutting device.

Turn off the engine immediately if anything goes wrong

In the following situations, turn off the engine immediately and ensure that the cutting device has stopped before checking each area of the product. Replace any damaged parts.

- If the cutting device hits a rock, tree, post, or other such obstruction while you work.
- If the product suddenly starts to vibrate abnormally.
- ◆ Continuing to use parts when they are damaged could lead to an accident or serious injury.

The area within a 15 m radius is a danger zone

The area within a 15 m radius of the product is a danger zone. Be careful to observe the following precautions while working with the product.

- Do not allow children and other people or pets to enter the danger zone.
- If another person enters the danger zone, turn off the engine to stop the blades.
- When approaching the operator, signal to him by, for example, throwing twigs from outside the danger zone, and then check that engine has been switched off and the blades has stopped moving.
- Do not allow anyone to hold the material you are cutting.
- ◆ Any contact with the cutter blades could cause serious injury.

Do not use the product when the cutter blades is moving at idle speed

- You must not use the product while the cutter blades is moving if the Hedge Clipper is running with the throttle trigger in the idle speed position. Turn off the engine immediately and adjust the carburettor.
- ◆ To do so could lead to an accident or serious injury.

Operation

- Hold the front and rear handles with both hands with thumbs and fingers tightly encircling the handles.
- Never remove hands from the product when the blades are moving.
- Only adjust cutting angle with unit resting flat on the ground, with the switch in the "STOP" position. Never adjust blade angle while standing.
- ◆ Failure to observe these instructions will cause the product to be held unsteadily and could result in serious injury.

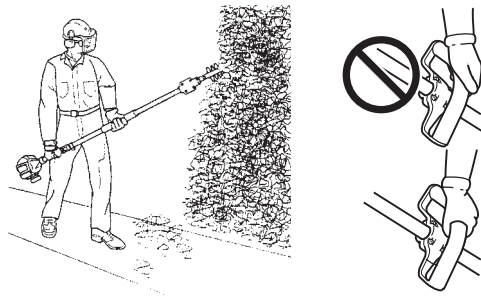

Make sure that the cutter blades is stopped before putting the product on the ground

- When you turn off the engine, check to ensure the cutter blades has stopped moving before you lower the product to the ground.
- ◆ Even if the engine has been turned off, the blades can still cause an injury while free-wheeling.



Remove debris from the silencer

- If objects such as grasses, leaves, twigs or excessive grease got stuck over the area around the silencer of the engine, stop the engine and remove them paying attention not to touch hot spots.
- ◆ Failure to do so could lead to a fire.



WARNING

Do not use the product to cut hard objects

- Do not use the product to cut hard objects such as wires or steel plates.
- If the blades strikes an obstruction or is prevented from functioning properly, stop the engine and inspect the blades for damage.
- ◆ Failure to follow these instructions could cause breakage of the product or an accident.

Never use the product getting on a ladder or a stool

- Do not overreach or stand on unstable surfaces.
- Do not use the product when being at the top of the ladder or standing on a stool.
- ◆ Failure to do so could lead to an accident or serious injury.

Protective gear

WARNING

Wear protective gear

Always wear the following protective gear when working with the hedge trimmer.

- a **Head protection (helmet):** Protects the head
- b **Ear muffs or ear plugs:** Protect the hearing
- c **Safety goggles:** Protect the eyes
- d **Safety gloves:** Protect the hands from cold and vibration
- e **Work clothes that fit (long sleeves, long trousers):** Protect the body
- f **Heavy duty, non-slip protective boots or non-slip work shoes :** Protect the feet

◆ Failure to observe these precautions could result in damage to your sight or hearing, or lead to a serious injury.

When necessary, please use the protective gear below.

- **Dust mask:** Protects the breathing apparatus
- **Bee net:** To deal with attacks by bees
- **Full face shield:** When trimming overhead, wear head protection meeting CE with a full face shield.

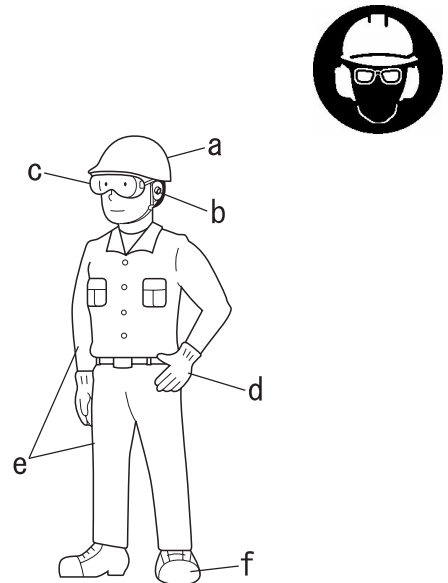

Wear proper clothing

Do not wear ties, jewellery, or loose, dangling clothing which could be caught in the unit. Do not wear open toed footwear, or go bare-foot or barelegged.

◆ Failure to observe these precautions could result in damage to your sight or hearing, or lead to a serious injury.



Packing list

- ♦ The following parts are packed separately in the packing box.
- ♦ When you have unpacked the box, please check the parts that it contains.
- ♦ Contact your ECHO DEALER if anything is missing or broken.

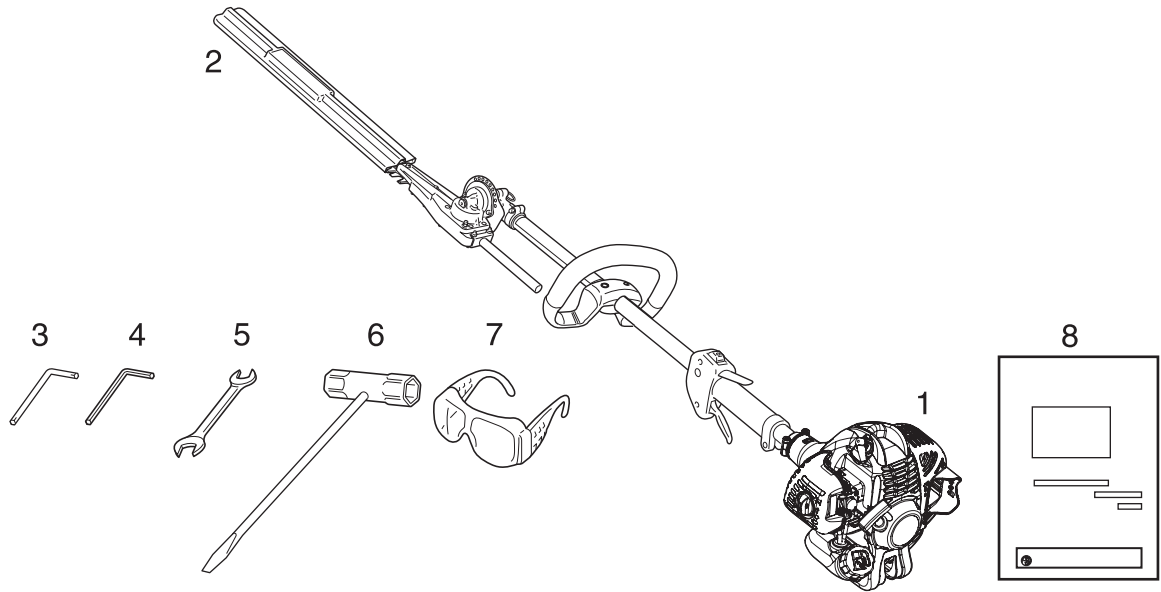

Number	Part name	Quantity
1	Power head with drive shaft	1
2	Blade cover	1
3	L-wrench	1
4	4 mm hexagonal wrench	1
5	Open end wrench	1
6	T-wrench	1
7	Safety glasses	1
8	Operator's manual	1

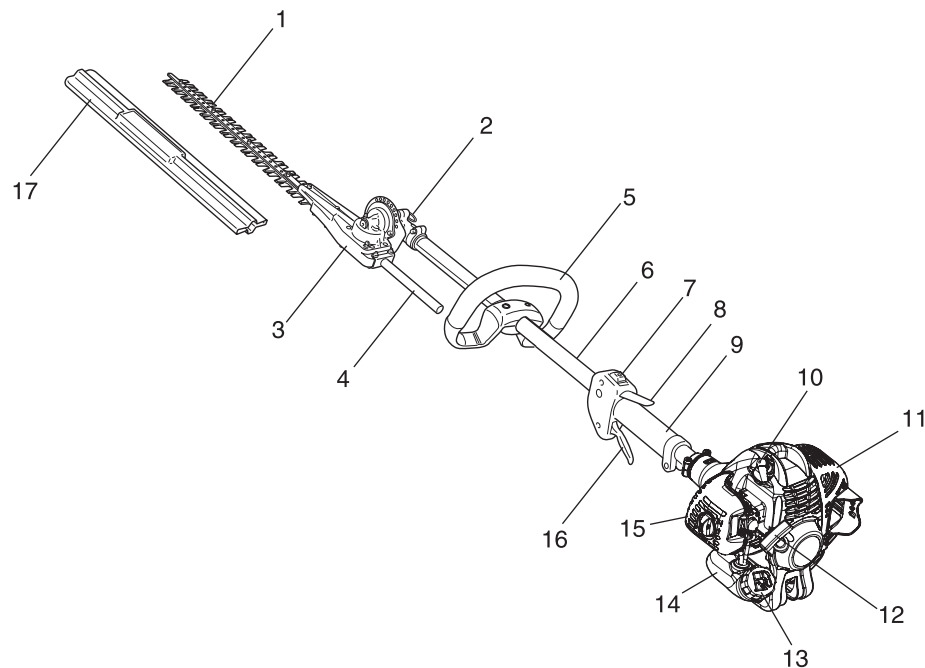

- 1. Blades** Double reciprocating blades mounted to a blade support bar. Double-sided blades are capable of cutting on either side of the blade.
- 2. Blade indexing ring** Pull ring out and turn 1/4 turn to lockout position when adjusting blade angle.
- 3. Gear housing assembly** Gear housing contains drive gears for transmitting power to cutting blades. Pivoting design permits blades to articulate 75 degrees in 15-degree increments.
- 4. Blade adjustment handle** Provides secure hand grip for adjusting cutting blade angle.
- 5. Front handle (for the left hand)** Handle located towards the cutting device.
- 6. Drive shaft assembly** Includes the flex drive shaft, rear handle assembly, front handle and safety decal.
- 7. Ignition switch** Controls engine ignition. Move switch forward to start and run engine, back to "STOP" position to stop engine.
- 8. Throttle trigger lockout** Locks throttle trigger in the idling position until you have a proper grip with your right hand around the handle.
- 9. Grip, right hand, rear** Cushioned grip for Right Hand.
- 10. Spark plug**
- 11. Silencer cover** Cover the silencer not to make operator touch to hot surface of silencer.
- 12. Starter handle** Pull handle to start the engine. ("**ES**" **START**)
- 13. Fuel tank cap** For closing the fuel tank.
- 14. Fuel tank** Contains fuel and fuel filter.
- 15. Air cleaner cover** Covers air filter.
- 16. Throttle trigger** Activated by the operator's finger for controlling the engine speed.
- 17. Blade cover** Used to cover blade during transport and storage. Remove blade cover before using unit.

Before you start

Assembly

WARNING

Read the operator's manual carefully to ensure that you assemble the product correctly.

◆ Using a product that has been incorrectly assembled could lead to an accident or serious injury.

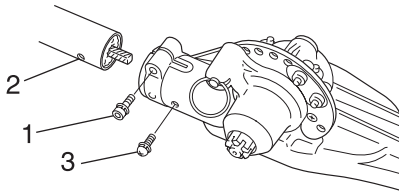

- 1. Bolt
- 2. Locating hole
- 3. Screw

Tools required:

4 mm hexagonal wrench, Screw driver.

Parts required:

Power head with drive shaft assembly and gear box with blade assembly.

1. Slide the gear box with blade assembly on the drive shaft. Be certain the flex drive shaft engages the hole in driver gear.
2. Align the screw with the locating hole in the drive shaft housing, tighten screw and bolt.

WARNING

- **Wear heavy duty gloves when working with the hedge clipper blades. When replacing the hedge clipper blades during a trimming task, ensure that the engine is switched off and that the blades have stopped.**
- **Ensure that the fuel tank cap is securely in place.**
- ◆ Failure to do so could lead to an injury or serious accident, or cause a fire.

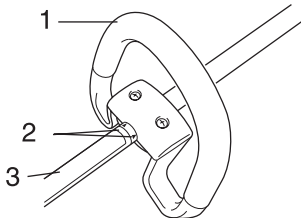

- 1. Front handle
- 2. Arrow mark
- 3. Safty decals

IMPORTANT

Do not install the handle to be located farther from you than the arrow mark (▲) and the safety decals.

Adjusting Cutting Angle

DANGER

- Never adjust cutting assembly with engine running.
- ◆ Failure to do so could lead to an injury or serious accident.

WARNING

- Hedge clipper blades are sharp. Always wear gloves when adjusting cutting assembly.
- Do not stand hedge clipper on end when adjusting cutting angle, otherwise serious injury may result.
- Gear case assembly becomes HOT during use. Always grip assembly at blade-adjustment handle when making cutting angle adjustments, otherwise serious injury may result.
- ◆ Failure to do so could lead to an injury or serious accident.

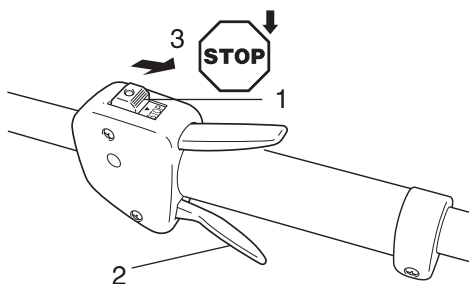

1. Ignition switch 2. Throttle trigger

1. Place unit on a flat clear area. Assure Ignition Switch is in the "STOP" position.

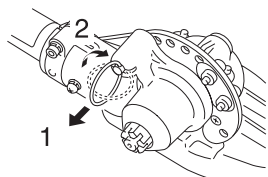

1. Indexing ring 2. 1/4 turn

2. Pull out indexing ring, and turn 1/4 turn to lockout position.

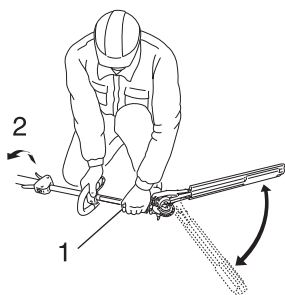

1. Adjustment handle 2. 1/4 turn

3. Turn hedge clipper 1/4 turn so that indexing ring faces downward.
4. Rotate blades to desired cutting position.

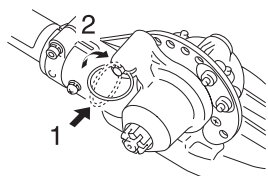

1. Indexing ring 2. 1/4 turn

5. Turn indexing ring 1/4 turn to lock blade in place.

Before you start

Preparing the fuel

DANGER

- Fuel is highly inflammable and there is a risk of fire if it is handled incorrectly. Carefully read and observe the precautions in the section of this manual titled "For safe use of your product".
- Once the refuelling is complete, securely tighten the fuel tank cap and do not forget to check that there are no leaks or discharges of fuel from the fuel pipe, fuel system grommets, or around the fuel tank cap. If you do find fuel leaks or discharges, stop using the product immediately and contact your ECHO DEALER to have it repaired.
- ◆ If the fuel ignites, it could cause burns and fire.



CAUTION

There is difference in pressure between the fuel tank and the outside air. When refuelling, loosen the fuel tank cap slightly to eliminate the difference in pressure.

- ◆ Otherwise, fuel may get spewed.

NOTE

Stored fuel ages. Do not mix more fuel than you expect use in thirty (30) days. Do not mix directly in fuel tank.

Fuel



- ◆ Fuel is a mixture of regular grade petrol and an air-cooled 2-stroke engine oil of reputable brand name. Minimum 89 Octane unleaded petrol is recommended. Do not use fuel containing methyl alcohol or more than 10 % of ethyl alcohol.
- ◆ Recommended mixture ratio; 50 : 1 (2 %) for ISO-L-EGD Standard (ISO/CD 13738), JASO FC, FD grade and ECHO Premium 50 : 1 oil.
 - Do not mix directly in engine fuel tank.
 - Avoid spilling petrol or oil. Spilled fuel should always be wiped up.
 - Handle petrol with care, it is highly inflammable.
 - Always store fuel in approved container.

Fuel supply

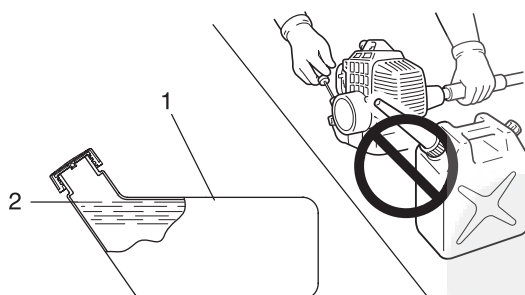

1. Fuel tank

2. Shoulder level

- ◆ Always refuel in a well ventilated location. Do not pour fuel indoors.
- ◆ Place the product and the refuelling tank on the ground when performing the refuelling operation. Do not refuel the product on the loading platform of a truck, or in other such places.
- ◆ Always ensure that the fuel level remains below the shoulder level of the fuel tank when refuelling.
- ◆ There is a difference in pressure between the fuel tank and the outside air. When refuelling, loosen the fuel tank cap slightly to eliminate the difference in pressure.
- ◆ Always wipe up any fuel spills.
- ◆ Move at least 3m away from where you refueled before you start the engine.
- ◆ Keep the refuelling tank in a shaded area away from fire.

Starting the engine

WARNING

- When starting the engine, observe the precautions described from Page 4 in the section "For safe use of your product" to ensure that you operate the product correctly.
- The attachment will operate immediately when the engine starts and could result in loss of control and possible serious injury. Keep movable parts of the attachment off the ground and away from objects that could become entangled or thrown.
- If the blades moves even though the throttle trigger is in the idle speed position when the engine is started, adjust the carburettor before using the product.
- Blades will start moving as engine attains clutch engagement speed.
- ◆ Failure to observe the precautions could cause an accident or injury, or even lead to a fatality.

NOTE

- ◆ Pull out the starter grip gently at first, and then more rapidly. Do not pull the starter rope out to more than 2/3 of its length.
- ◆ Do not let go of the starter grip as it returns.

Starting a cold engine

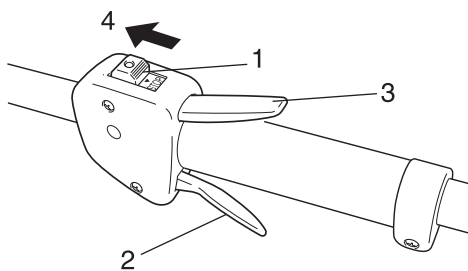

- | | |
|---------------------|-----------------------------|
| 1. Ignition switch | 3. Throttle trigger lockout |
| 2. Throttle trigger | 4. Start |

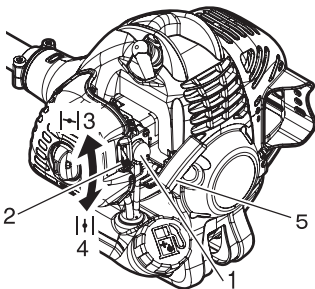

- | | |
|----------------|-------------------|
| 1. Purge bulb | 4. Run |
| 2. Choke lever | 5. Starter handle |
| 3. Cold Start | |

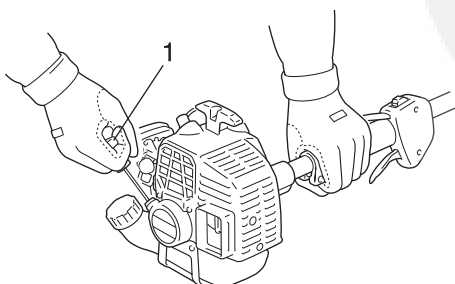

1. Starter handle ("ES" START)

(Connect the spark plug cap if the product has been in storage for a long period of time)

The starting procedure depends on whether the engine is cold or warm. A cold engine is started as follows.

1. Remove the blade cover and check the cutter blades. If anything is wrong, replace it with a new one.
2. Placing the product on level ground, check to ensure that the blades does not come into contact with the surface of the ground or any other impediment using a beam or other such implement.
3. Check that there are no fuel leaks.
4. Move the ignition switch to the Start position.
5. Move the choke lever to the "Cold Start" position.
6. Alternately press and release the purge bulb until the fuel is sucked up into it.
7. Checking that the area around you is safe, hold the front handle firmly with your right hand as shown in the illustration, pulling several times on the starter grip.
8. If you hear an explosion-like sound and the engine stops immediately, move the choke lever to the "Run" position and continue pulling on the starter grip to start the engine.
9. If the engine starts immediately when you carry out the instructions in step 7, above, return the choke lever gently to the "Run" position.
10. Leave the engine to warm up at idle speed for a while.
11. Depress the throttle trigger lockout and gradually squeeze the throttle trigger.

Engine operation

Engine warm-up

1. Once the engine starts, allow it to warm up for 2 to 3 minutes at idling (i.e. low speed).
2. Warming the engine helps to lubricate its internal workings more smoothly. Allow the engine to warm up fully, especially when it is cold.

Starting a warm engine

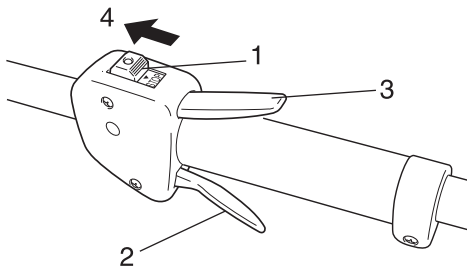

1. Ignition switch
2. Throttle trigger
3. Throttle trigger lockout
4. Start

1. Move the ignition switch to the Start position.
2. Make sure that the throttle trigger is at the idle speed position.

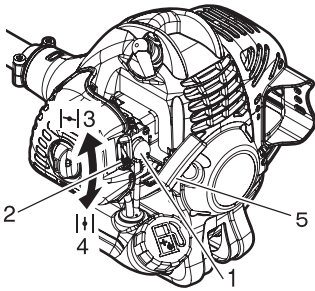

1. Purge bulb
2. Choke lever
3. Cold Start
4. Run
5. Starter handle

3. Check that the choke lever is in the "Run" position.
4. If fuel tank is not empty, pull on the starter grip to start the engine.
5. If no fuel is visible in the purge bulb, alternately press and release the purge bulb until the fuel is sucked up into it.
6. Checking that the area around you is safe and pull on the starter grip to start the engine.

Stopping the engine

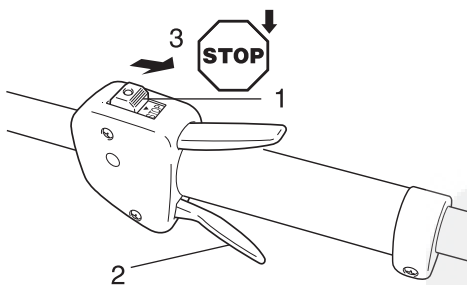

1. Ignition switch
2. Throttle trigger

1. Release the throttle trigger and set the engine to idling (i.e. low speed).
 2. Move the ignition switch to the Stop position.
 3. In the event of an emergency, stop the engine immediately using the ignition switch.
 4. If the engine fails to stop, move the choke lever to the "Cold Start" position. The engine will stall and come to a halt (a choke stop).
- * If the engine fails to stop when the ignition switch is used, have the ignition switch checked and repaired by your ECHO DEALER before you use the product again.

Hedge and shrub trimming operation

Basic hedge trimming operation

NOTE

- ♦ This product is designed to cut shrubs and hedges with branches no larger than 6 mm in diameter.
- ♦ When starting to trim, run the engine at full throttle. Cutting at less than full speed can damage the clutch by allowing it to slip. When you do not conduct trimming or cutting work, do not run the engine at full throttle.

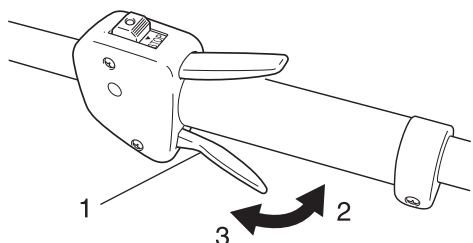

- 1. Throttle trigger
- 2. High speed

3. Idling

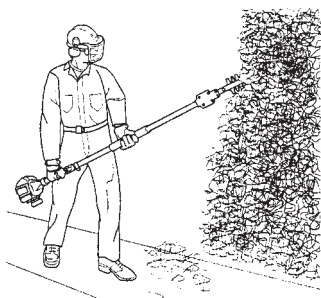

Pulling the throttle trigger after the engine is started will cause the engine speed to rise and the cutter blades to start moving. Adjust the engine speed depending on, for example, the amount of the hedges to be cut.

1. Hold trimmer firmly and squeeze throttle trigger to accelerate engine.
2. Tilt trimmer so cutting teeth are angled slightly toward the hedge or shrub and proceed to cut.

WARNING

- **Never remove hands from unit when blades are moving.**
- **The engine continues running even when the blades have stopped due to an obstruction. If this occurs, stop the engine, disconnect ignition cable and remove the obstruction.**
- ◆ Failure to do so could lead to an injury or serious accident, or cause a fire.

Maintenance and care

Servicing guidelines

Area	Maintenance	Page	Before use	Monthly
Air filter	Clean/Replace	20	•	
Fuel filter	Inspect/Clean/Replace	21	•	
Spark plug	Inspect/Clean/Adjust/Replace	23		•
Carburettor	Adjust/Replace and adjust	21		•
Cooling system	Inspect/Clean	21	•	
Silencer	Inspect/Tighten	22		•
Silencer	Clean	22		•*
Drive Shaft	Grease	24		•**
Gear housing	Grease	24		•***
Starter	Inspect	-	•	
Blades	Inspect/Clean/Lubricate	23	•	
Fuel system	Inspect	22	•	
Screws, bolts and nuts	Inspect/Tighten/Replace	-	•	

IMPORTANT

Time intervals are maximum. Actual use and your experience will determine the frequency of required maintenance. Record dates of monthly and yearly inspections.

* Or 100 hours, whichever occurs first.

** Or 25 hours, whichever occurs first.

*** Or 15-25 hours, whichever occurs first.

Maintenance and care

If you have any questions or problems, please contact your ECHO DEALER.

Cleaning air filter

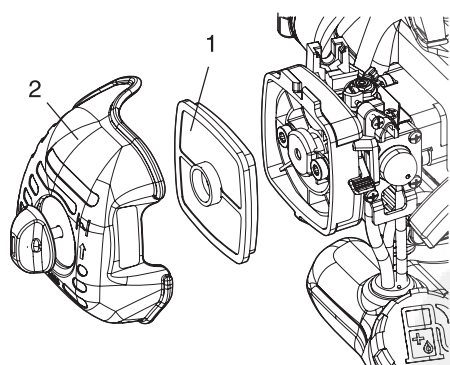

1. Air filter

2. Air cleaner cover

- ♦ Close choke. Loosen air cleaner cover knob and remove air cleaner cover.
- ♦ Remove air filter (air filter is located inside air cleaner cover).
- ♦ Brush dirt from filter or clean with compressed air.
- ♦ Reinstall air filter with cover, after installing air filter to cover.
- ♦ Tighten air cleaner cover knob.