

AL-KO
QUALITY FOR LIFE

GB



INFORMATION | MANUALS | SERVICE

ROBOLINHO® 3000

Robot lawnmower
Operating Instructions



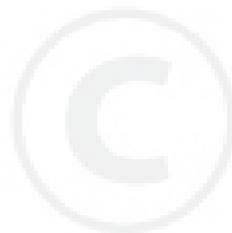

© 2012

AL-KO KOBER GROUP Kötz, Germany

This documentation or excerpts therefrom may not be reproduced or disclosed to third parties without the express permission of the AL-KO KOBER GROUP.

Original operating instructions

Contents

14	About this handbook.....	45
14.1	Explanation of symbols.....	45
14.2	Disposal.....	45
15	Scope of delivery.....	46
15.1	Unpacking the machine.....	46
16	Product description.....	47
16.1	Product description.....	47
16.2	Designated use.....	47
16.3	Possible misuse.....	47
16.4	Base station.....	48
16.5	Transformer.....	48
16.6	Boundary cable.....	48
16.7	Control panel.....	49
16.8	Sensors.....	50
17	Safety instructions.....	51
17.1	51
17.2	Safety and protective equipment.....	51
18	Assembly.....	52
18.1	Assembling the base station.....	52
18.2	Setting up the base station.....	52
18.3	Laying the boundary cable.....	53
19	Electrical Installation.....	56
19.1	Connecting the boundary cable to the base station.....	56
19.2	Connecting the low-voltage cables to the transformer.....	56
19.3	Opening the base station.....	57
19.4	Checking the connection.....	57
20	Startup.....	58
20.1	Preparations.....	58
20.2	Transport.....	58
20.3	Switching on.....	59
20.4	Checking the cable laying.....	62
21	Programming.....	63
21.1	Overview of main menu.....	63

21.2	Starting programming.....	63
21.3	Selecting the menu.....	64
21.4	Program menu.....	64
21.5	Setting menu.....	66
21.6	Information menu.....	69
21.7	Program information.....	69
21.8	Faults.....	70
22	Mowing.....	71
17	Safety instructions.....	51
22.2	Setting the cutting height.....	71
22.3	Starting the Robolinho.....	72
22.4	Mowing tips.....	72
23	Maintenance and care.....	73
23.1	Cleaning.....	73
23.2	Cleaning the chassis.....	73
23.3	Checking contacts.....	73
23.4	Checking the base station.....	74
23.5	Check the rollers can move freely.....	74
23.6	Renewing the cutting blade.....	74
23.7	Renewing the transformer fuse.....	75
23.8	Battery status check.....	75
23.9	Charging the battery.....	75
23.10	Exhaustively discharged battery.....	76
23.11	Storage.....	76
23.12	Repairs.....	76
24	Troubleshooting.....	77
24.1	Examples of fault messages.....	80
25	Technical data.....	81
26	Appendix.....	82
26.1	Warranty.....	82
26.2	EC declaration of conformity.....	82

14 About this handbook

- Read this documentation before starting up the machine. This is a precondition for safe working and flawless operation.
- Observe the safety warnings in this documentation and on the product.
- This documentation is a permanent integral part of the product described and must be passed on to the new owner if the product is sold.

14.1 Explanation of symbols

**CAUTION!**

Following these safety warnings carefully can prevent personal injury and/or material damage.



Special instructions for greater ease of understanding and improved handling.

14.2 Disposal

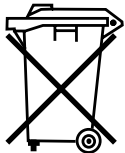
**Do not dispose of old equipment, batteries or accumulators as household waste!**

Product, packaging, and accessories were made with recyclable materials, and should be disposed of accordingly.

Dispose of in accordance with local regulations.

The following disposal options are available:

- Via the retailer.
- Via a return station identified with the CCR mark.
- Do not dispose of the battery unless it is discharged.
- The user is obliged to return the battery. It can be returned to an AL-KO dealer, technician or service partner free of charge.

15 Scope of delivery

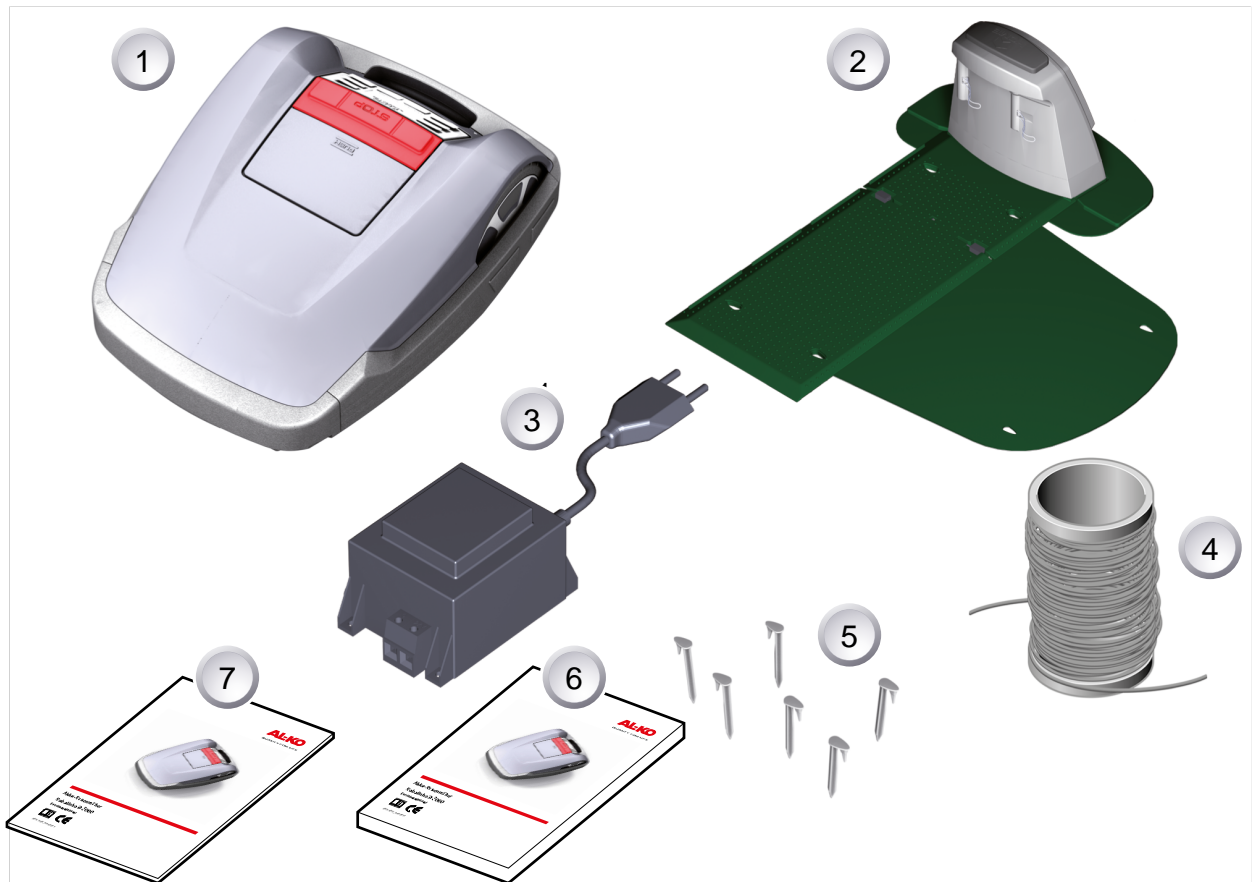

1	Robolinho® 3000	5	Lawn pegs (180 pcs.)
2	Base station	6	Instructions for use
3	Transformer	7	Quickstart guide
4	Boundary cable (150 m)		

15.1 Unpacking the machine

- Carefully unpack the Robolinho® 3000 and its components and check everything for damage in transport. If there is any transport damage, immediately notify your AL-KO dealer, technician or service partner in accordance with the warranty conditions.
- If the Robolinho® 3000 was sent by a parcel service, retain the original packaging and accompanying documents.

16 Product description

The Robolinho® 3000 is a fully automatic, batteryoperated lawnmower which moves freely within a defined mowing area. The mowing area is defined by a boundary cable that is connected to the base station. In order for its battery to be recharged, the Robolinho® 3000 moves along the boundary cable into the base station. The Robolinho® 3000 is equipped with a rain sensor. Depending on the setting, the Robolinho® 3000 either automatically returns to the base station when it starts raining, or continues to mow in the rain.

Mowing programs are pre-installed for normal mowing, and also include the lawn and edge mowing function. These mowing programs can be changed. In addition, it is possible to set various "entry points" along the loop. The Robolinho® 3000 automatically moves to the entry points according to the programming, and starts mowing from there. The special arrangement of blades means that the mown grass is not gathered up but remains on the lawn between the stalks of grass. As a result, it has a mulching or fertilising effect.

16.1 Product description

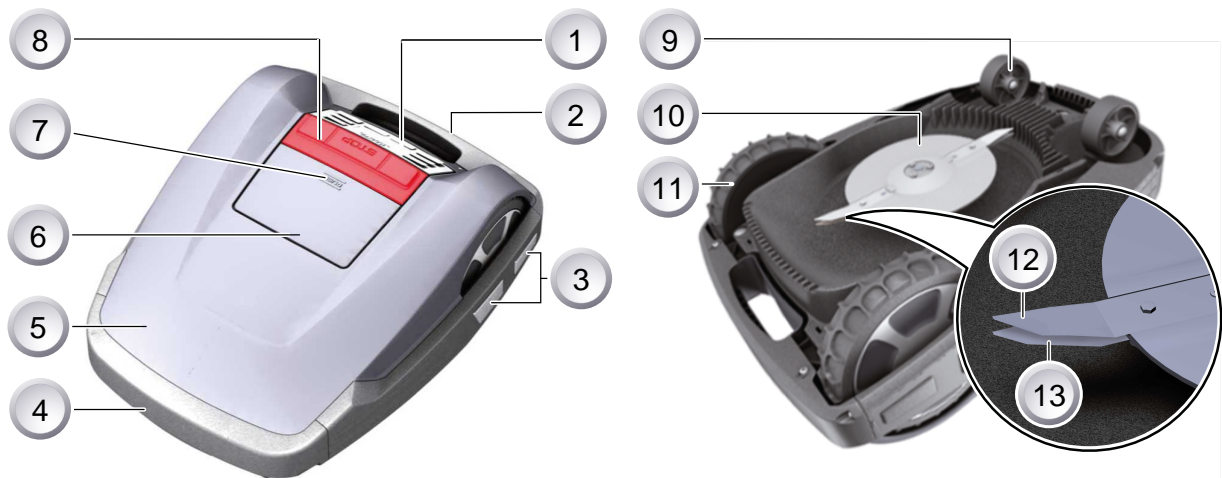

1	Control panel	8	STOP key
2	Carry handle	9	Front wheels
3	Charging contacts	10	Blade plate
4	Bumper	11	Drive wheels with high-grip tread
5	Housing	12	Cutter blades
6	Cover plate (fl ap for height adjustment)	13	Clearer blades
7	Height adjustment interior		

16.2 Designated use

This device is exclusively intended for mowing private lawns. Any other use is regarded as not in accordance with the designated use.

16.3 Possible misuse

This device is not suitable for use in commercial enterprises, public facilities, parks, sports facilities or in agriculture and forestry.

16.4 Base station

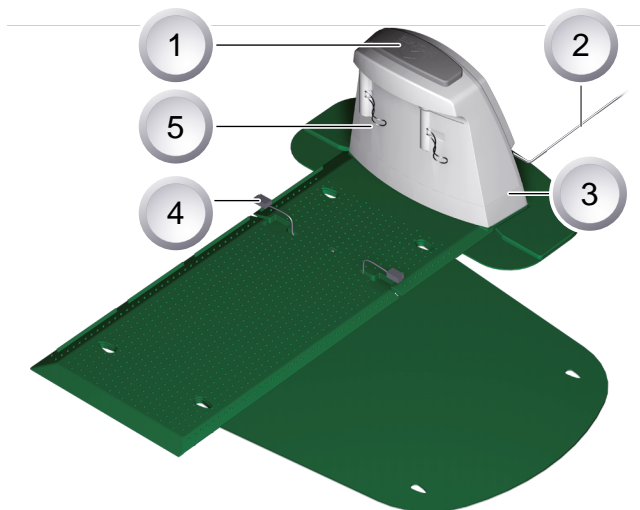

1	[HOME key]	4	Boundary cable
2	Low-voltage cable	5	Charging contacts
3	Base station		

The base station is connected to the electrical power supply (transformer) using the low-voltage cable. The base station generates a control signal and sends this in the boundary cable.

There are two charging contacts on the base station which contact the charging contacts on the Robolinho® 3000 as soon as it moves into the base station. The [HOME key] is located on the base station. Pressing this key causes the Robolinho® 3000 to terminate its current activity for the day, and it returns automatically to the base station.

16.5 Transformer

The transformer generates the power for the base station..



CAUTION!

Damage due to splash water!

Transformer put in a dry place where it is protected against splash water.

16.6 Boundary cable

The boundary cable is secured with lawn pegs. If the supplied boundary cable is not large enough for your lawn, you can obtain an extension cable from your AL-KO dealer, technician or service partner.



CAUTION!

Damage to the boundary cable!

Do not scarify the lawn in the area on either side of where the boundary cable is laid.

16.7 Control panel



1	HOME key	6	START/PAUSE key
2	LCD display	7	Multifunction key right
3	STOP key	8	Multifunction key left
4	Up arrow key	9	ON/OFF key
5	Down arrow key	10	Menu key

Function of the keys

1	The [HOME key] cancels the current mowing procedure. The Robolinho moves to its base station. The Robolinhostarts on the next day, with the next mowing window.	6	Press the [START/PAUSE key] to start the Robolinho or interrupt operation. Caution - unit starts after 2 minutes automatically!
2	The [LCD display] displays the current status or the selected menu..	7	Use the [multifunction keys right or left] to confirm or revoke commands, for example (selecting a menu command).
3	Pressing the [STOP key] stops the Robolinho and the cutting blade within 2 seconds.	8	
4	The [up arrow key and down arrow key] are used for navigating in the menu and for changing values.	9	The [ON/OFF key] is used for switching the Robolinho on or off.
5		10	Press the [menu key] to open the menu.

16.8 Sensors

Security sensor

If the Robolinho® 3000 is lifted up by its carry handle during operation, a safety sensor stops the blade within 2 seconds and switches off travel mode.

Rain sensor

The Robolinho® 3000 is equipped with a rain sensor that interrupts the mowing procedure in case of rain, and ensures that the Robolinho returns to its base station.

Bump sensors and obstacle detection

The Robolinho® 3000 is equipped with sensors that ensure it changes its direction of travel if it encounters obstacles. When it encounters an obstacle, the top part of the housing is shifted slightly. This causes a sensor to trigger a change in the direction of travel.



Tilt sensor in direction of travel

The Robolinho® 3000 is switched off by the tilt sensor if it encounters an upward or downward slope of more than 35%.

> 35 %

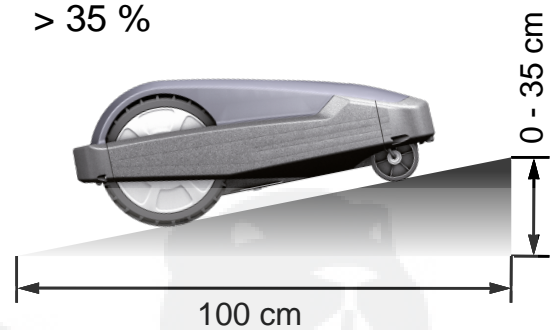

Tilt sensor on side

The Robolinho® 3000 is switched off by the tilt sensor if it encounters sideways slopes of more than 35%.

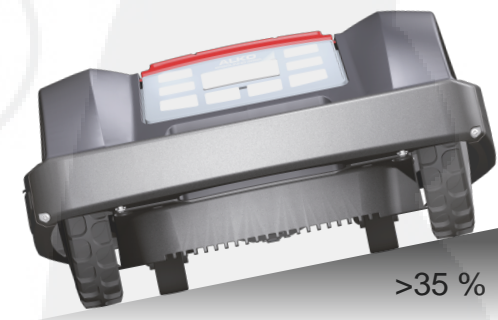

The Robolinho® 3000 does not restart automatically after being switched off by a safety sensor. To restart, it is necessary to acknowledge the fault by pressing the multifunction key and rectifying the fault.

17 Safety instructions

**CAUTION!****Risk of injury from unintentional starting!**

The Robolinho® 3000 must be switched off and secured with a PIN code.

- Please observe the safety and warning notices in this manual and on the product.
- The equipment should be used only if in good order and condition
- Device and base station regularly for damage.
- Have damaged parts and batteries replaced or repaired by an AL-KO dealer, technician or service partner.
- Keep body and clothing away from cutting parts.
- Children and other persons who are unfamiliar with the operating instructions must not operate the machine
- Keep others away from dangerous areas.
- The user is responsible for accidents involving other people and their property.

17.2 Safety and protective equipment

**CAUTION!****Risk of injury!**

Safety and protective devices should not be disabled.

- Safety devices are not allowed to be bypassed, manipulated or removed. Failure to comply can endanger your own health and that of other people.
- The Robolinho® 3000 is protected by a PIN code in order to prevent it from being switched back on inadvertently or without authorisation.
- The Robolinho® 3000 is supplied from the factory with the PIN code: [0 0 0 0]. The PIN code can be changed by the owner.
- A PUK code must be entered if the PIN code is entered incorrectly three times. Request this from your dealer.
- If the wrong PUK code is entered, the Robolinho 3000® will have to be sent in for it to be unlocked.
- The Robolinho® 3000 is equipped with a safety sensor. If he is lifted up, its motor and cutting blades are stopped within 2 seconds.
- After contact with an obstacle, the Robolinho® 3000 moves back, stops and changes its direction of travel.

18 Assembly

18.1 Assembling the base station

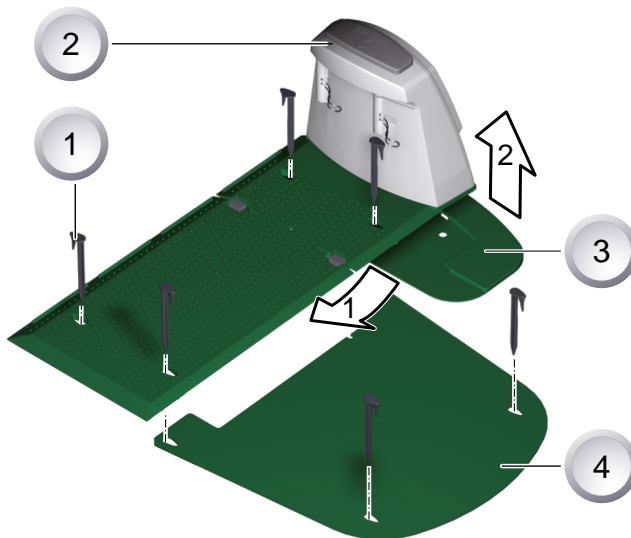

1. Insert the base plate (3) with its front edge in the direction of arrow 1 into the plate of the base station (2), and fold upwards in the direction of arrow 2.
2. Place the extension plate (4) under the base station (2) and secure it with lawn pegs (1).

18.2 Setting up the base station

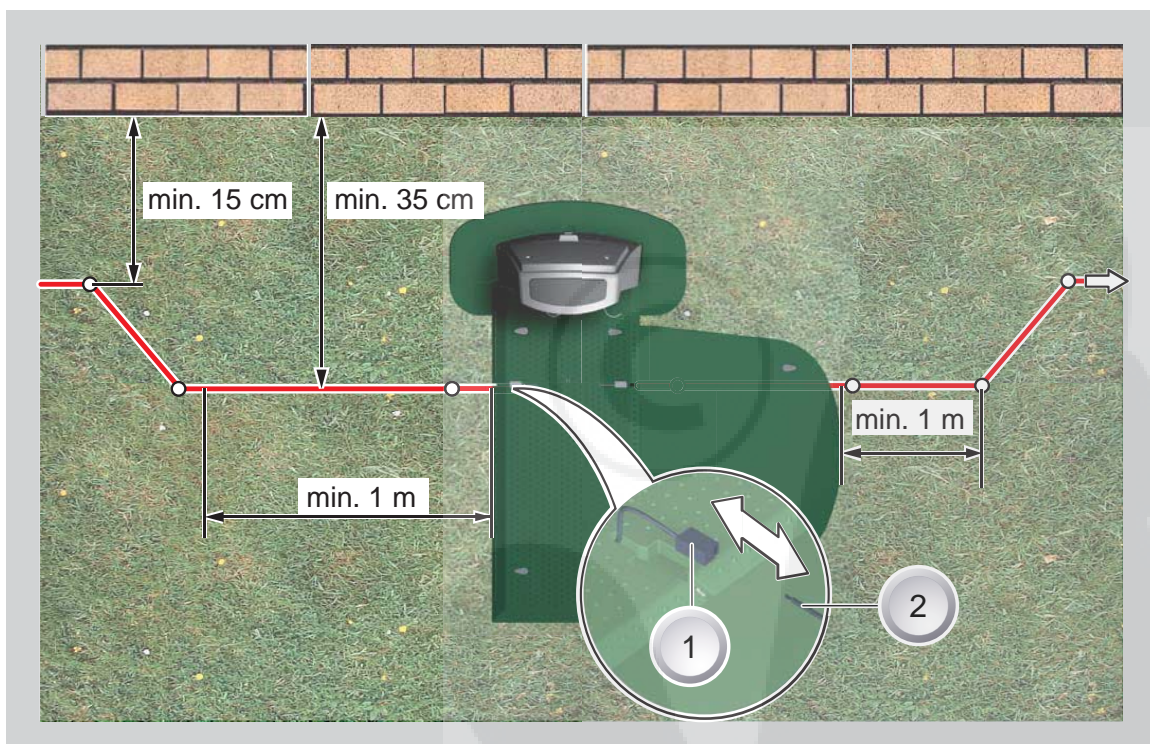

1. Place the base station in a shady location in the garden on smooth level ground where it will be protected against the rain. Then use lawn pegs to secure it in place (white dots). Comply with the specified dimensions when doing this.
2. Remove the insulation from the boundary cable (2) and connect it to one side (1) of the base station. Then continue to lay the cable as shown, complying with the specified distances.

3. To avoid damage when mowing, make sure that the boundary cable is in direct contact with the ground at all points when you are laying it.
4. If there are places where the boundary cable is not in direct contact with the ground, secure these with an additional lawn peg.

18.3 Laying the boundary cable



CAUTION!

Danger of damage to the boundary cable and impairment of function of the Robolinho® 3000!

To ensure reliable function, the boundary cable must be laid as described in the following steps.

1. Check the area to be mown.
2. Remove mole hills and windfall fruit, other foreign bodies and level out any holes in the area to be mown. Lay your boundary cable around obstacles.
3. Lay the boundary wire so tightly, that the robot lawn the cable when driving not drags.
4. Lawns with grass more than 8 cm tall cannot be mown using the Robolinho® 3000, and will have to be mown in advance before the boundary cable is laid.
5. Once the boundary cable has been laid on the grass, do not scarify the area of the boundary cable any longer.

18.3.1 Laying options

The boundary cable can be laid on the lawn (1) and as much as 10 cm under the turf (2). Have your dealer carry out the laying under the turf on your behalf.

⇒ *If necessary, you can also combine both methods.*

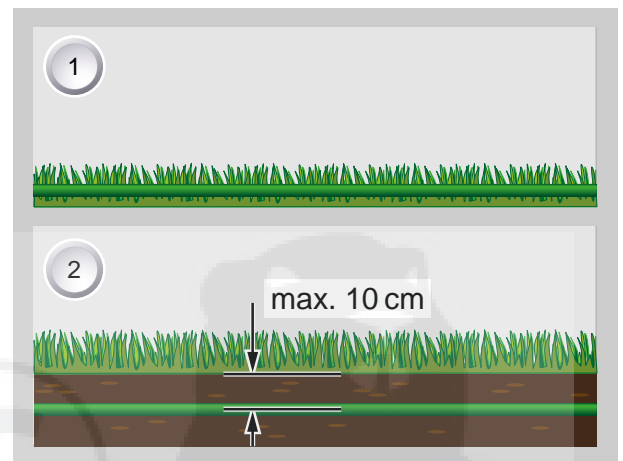

18.3.2 Spare loops of cable

You should incorporate spare loops of cable at regular intervals in order to allow the base station to be repositioned or the mowing area to be extended even after the mowing area has been laid out. To do this, guide the boundary cable around a lawn peg, return to the previous lawn peg, then continue as shown, securing with another lawn peg.

⇒ *Select the number of spare cable loops according to your own judgement.*

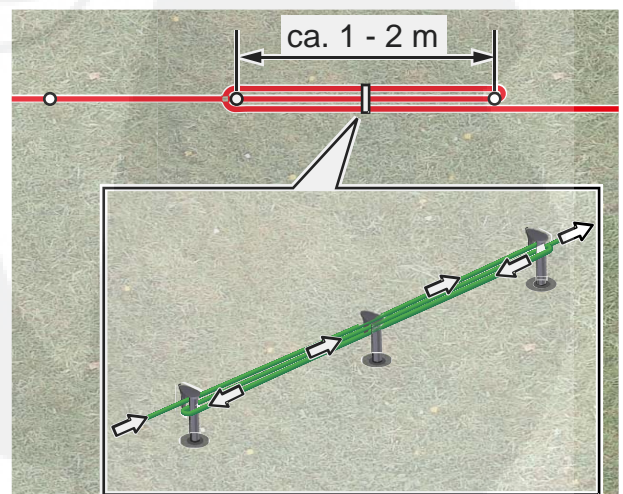

18.3.3 Route cable properly

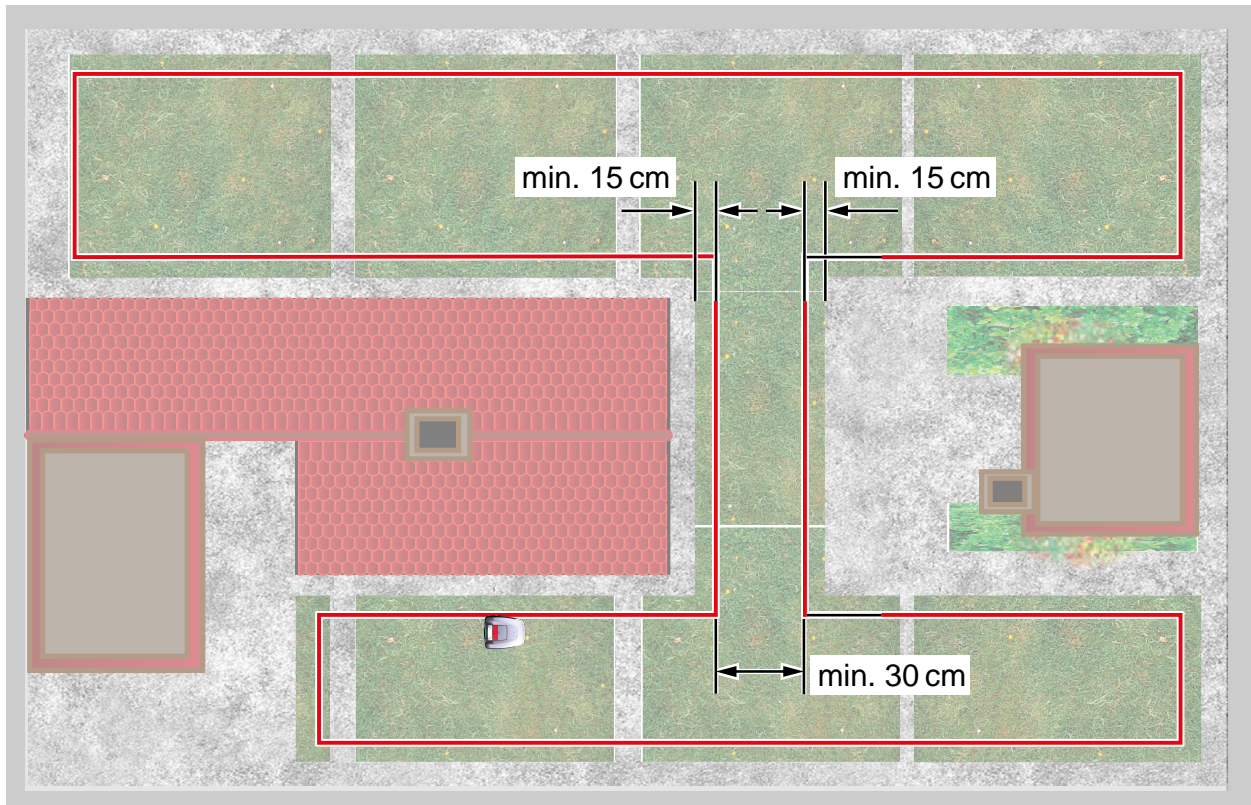

When laying the boundary cable in walkways, it is necessary to maintain the minimum distances from obstacles and the minimum passage width, otherwise the Robolinho® 3000 will not be able to operate correctly.

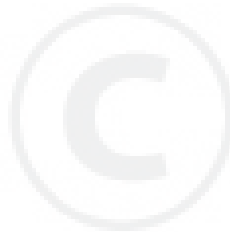

18.3.4 Laying the cable around obstacles

When laying the cable around obstacles, maintain the distances shown in the illustration.

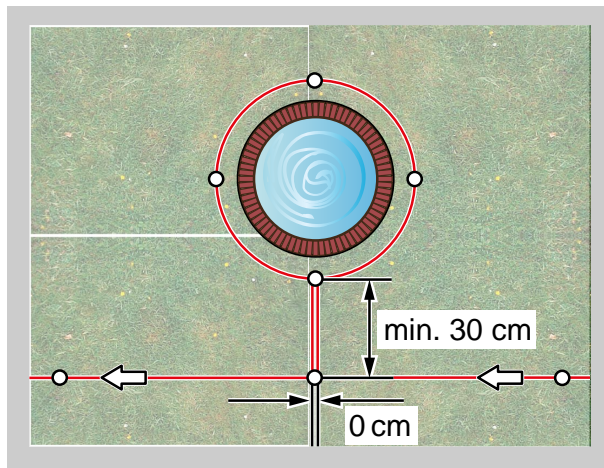

If there is a distance of 0 cm between the cables, it is possible for the cable to be driven over. In most cases, the best solution.

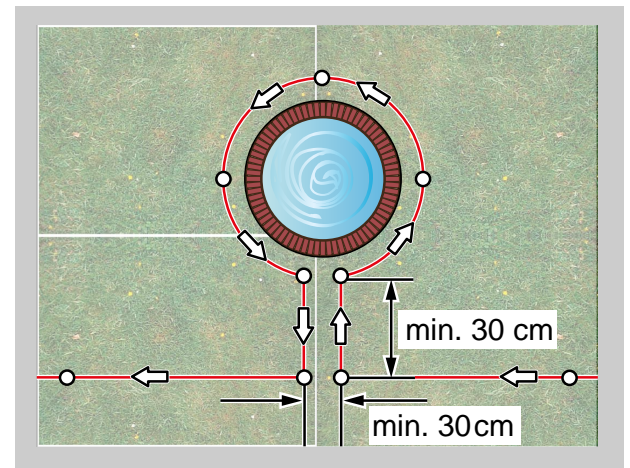

When the distance is at least 30 cm, the Robolinho® 3000 interprets the distance as a path and moves around the obstacle.

18.3.5 Cable cross embarrassed

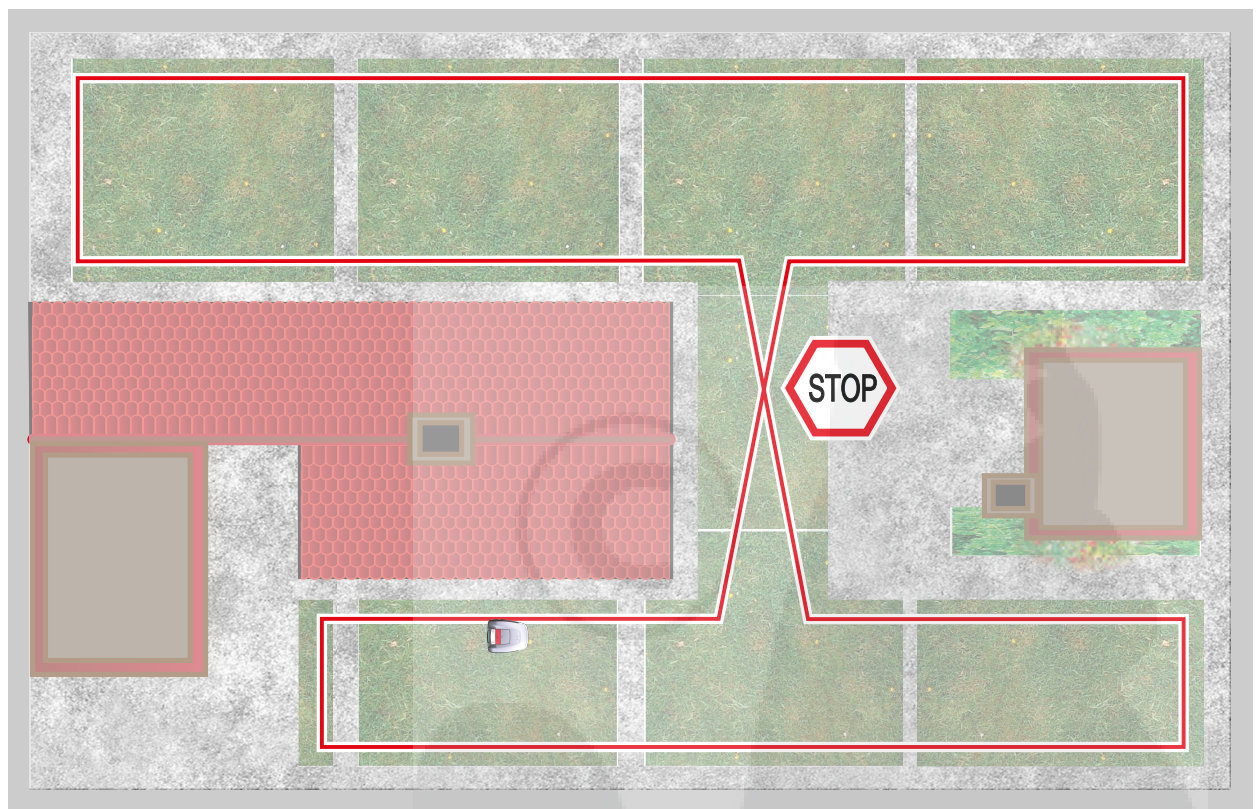

Crossovers in the boundary cable automatically cause the mowing procedure to be cancelled, because the Robolinho® 3000 cannot process the signals it receives at this point.

19 Electrical Installation

19.1 Connecting the boundary cable to the base station

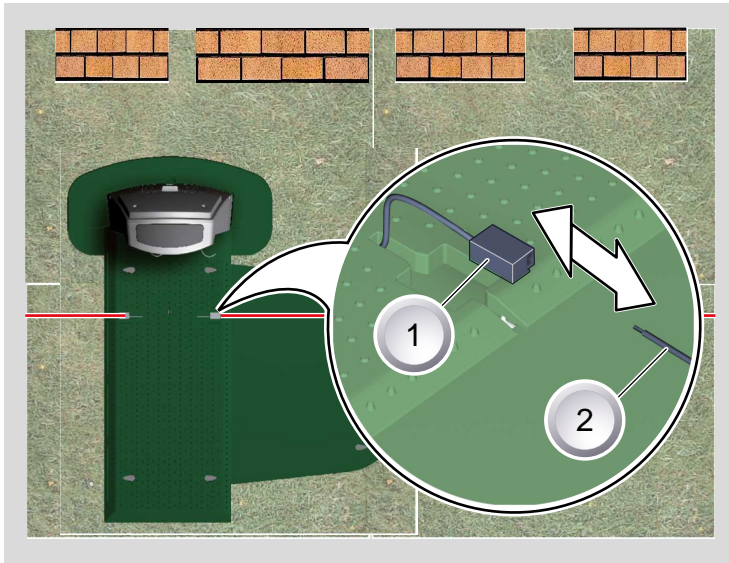

1. Remove the insulation from the boundary cable (2) after laying the cable and connect to the spring terminals (1).

19.2 Connecting the low-voltage cables to the transformer

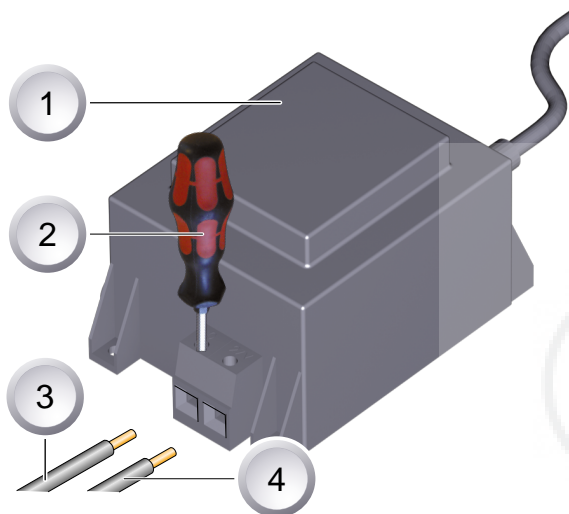

1. Strip 10 mm of insulation off the low-voltage cables (3 / 4).
2. Unscrew the screws with a screwdriver (2) and connect the low-voltage cables to the transformer (1).
⇒ *The cables can be connected to either terminal, there is no need to observe a particular polarity.*
3. Insert the mains plug of the transformer into the mains socket.

19.3 Opening the base station

The cover only has to be opened for the purpose of checking the LED displays.

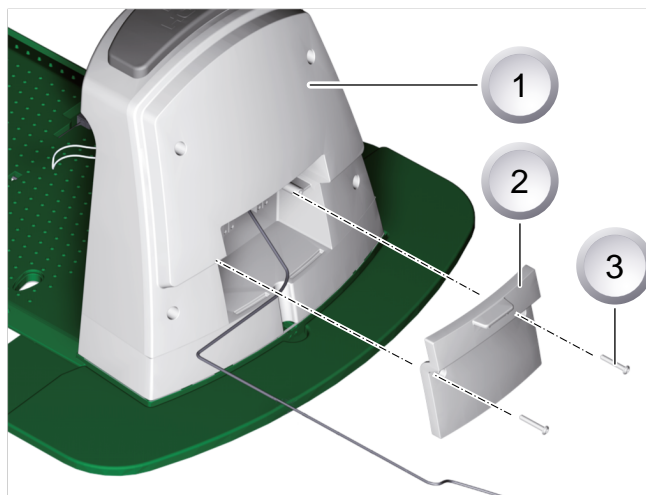

1. To check the connection, open the cover (2) on the rear of the base station (1).
2. Unscrew the fastening screws (3) and remove the cover from the base station.

19.4 Checking the connection

The LEDs must light up when the cables are connected. If this is not the case, pull out the mains plug and check if all plug connections and cables are correctly seated; also check them for damage.

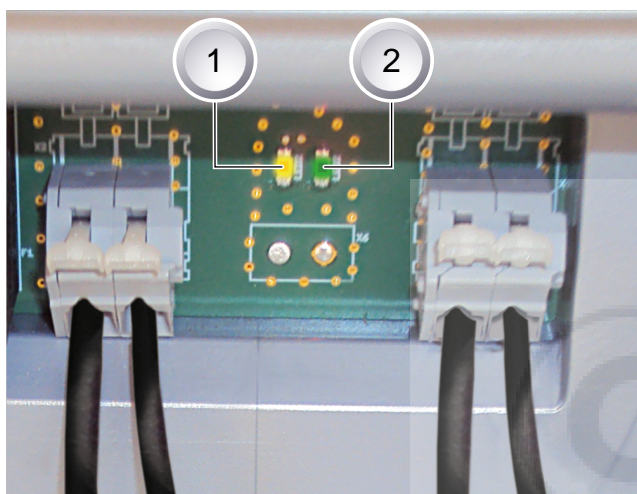

yellow LED (1)

- lights up if the base station is connected to the transformer and there is an electrical power supply to the transformer.
- fl ashes when the Robolinho® 3000 is charging.

green LED (2)

- lights up when the boundary cable is laid correctly and the loop is OK.
- fl ashes and then goes out if the loop of the boundary cable is not OK.

20 Startup

20.1 Preparations

Before starting to operate the Robolinho® 3000, place it in its starting position in the defined mowing area.

⇒ *Comply with the specified dimensions.*

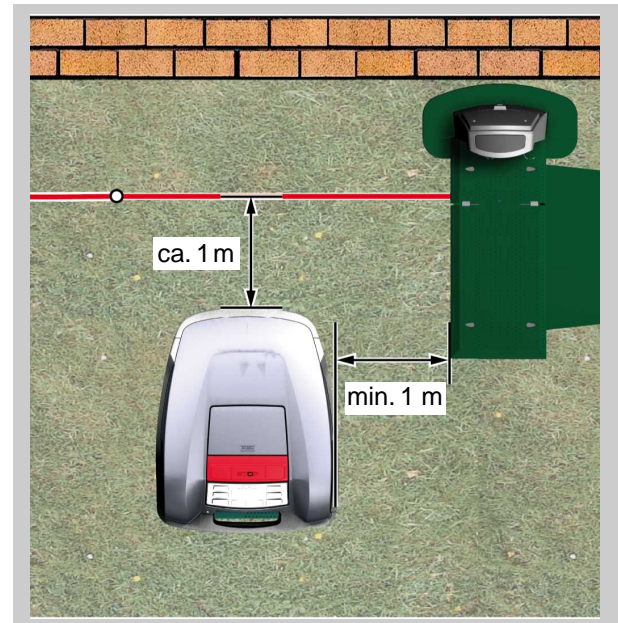

20.2 Transport

General



CAUTION!

Injuries due to the cutting blades!

Make sure the cutting blade plate is pointing away from your body.

1. Only carry the Robolinho® 3000 by its handle (1).

⇒ *Make sure the cutting blade plate (2) is pointing away from your body.*



Transporting within the mowing area

1. Stop the Robolinho® 3000 using [STOP key] (2).
2. Switch off Robolinho® 3000 at [ON/OFF key] (1).

**20.3 Switching on****Status display**

```

Brill
Model Roboline™ R30
Software # xxxxxx
Serial-number xxxxxx

```

1. Switch on the Robolinho by pressing the [ON/OFF key].
⇒ *The LCD display then shows the illustrated information:*

Display after the status display

```

TT.MM.JJJJ    00:00
  Uncalibrated
Press start key
Charge        93%

```

- The LCD display shows the information Uncalibrated.
⇒ *The LCD display automatically changes to the registration window for language selection.*

20.3.1 Language selection

The corresponding language only needs to be selected here during the initial start-up.

```

[ Select language ]
English
Deutsch
                Confirm

```

1. Use the [arrow keys] to select the required language.
2. Confirm with the [multifunction key].
⇒ *After confirming, the LCD display shows [Enter registration PIN].*

20.3.2 Enter PIN code

```

[   Registration   ]
Enter PIN
  ****

```

20.3.3 Entering the factory-set PIN code

The factory-set PIN code only needs to be entered during the initial start-up. The factory-set PIN code is [0 0 0 0].



1. Use the corresponding [arrow keys] (1) or (2) to select the corresponding digits and confirm each one with the [multifunction key] (4).
2. Enter the next 3 required digits in the same way.
3. Confirm the last entry with [multifunction key] (3).
 ⇒ Following this, the LCD display shows the [Change PIN] dialog box.

20.3.4 Changing the PIN code

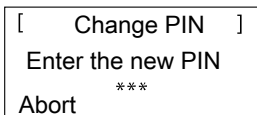

1. Enter a new PIN and repeat.
2. Confirm the last entry with [multifunction key].
 ⇒ After this, the LCD display shows the [Date dialog box].

20.3.5 Setting / changing the date

Enter the date and time correctly, because further programming depends on the date and time.

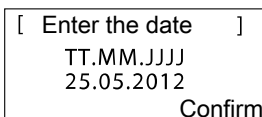

1. Use the corresponding [arrow keys] (1) or (2) to select the corresponding digits and confirm each one with the [multifunction key].
 ⇒ After confirming, the LCD display shows [Time dialog box].



When entering the year (YYYY), it is only necessary to enter the last two digits because the first two 20XX are preset.

20.3.6 Setting / changing the time

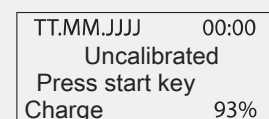
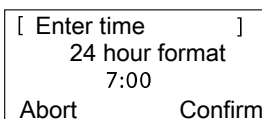

1. Use the corresponding [arrow keys] to select the corresponding digits and confirm each one with the [multifunction key].
 ⇒ Following this, the LCD display shows the [Uncalibrated] status box.

20.3.7 Calibration

For calibration, set up the Robolinho® 3000 accordingly, *see Preparations, page 58.*



CAUTION!

The drive starts when the [START key] is pressed.

Do not reach into rotating parts.

25.05.2012	09:48
! Warning !	
Drive starts	
Charge	92%

1. The automatic calibration procedure starts when the [START key] is pressed.

⇒ The [Drive starting] warning flashes on the LCD display.

20.3.8 Calibration procedure starts

25.05.2012	09:48
Calibration	
PHASE [1]	
Charge	92%

The Robolinho® 3000 first moves straight over the boundary cable in order to gauge the signal strength, and then into the base station. The battery of the Robolinho® 3000 is charged.



The Robolinho® 3000 must remain stopped when it moves into the base station.

If the Robolinho® 3000 does not meet the contacts when it moves into the base station, it will move further along the boundary cable until it meets the contacts or the procedure is cancelled.

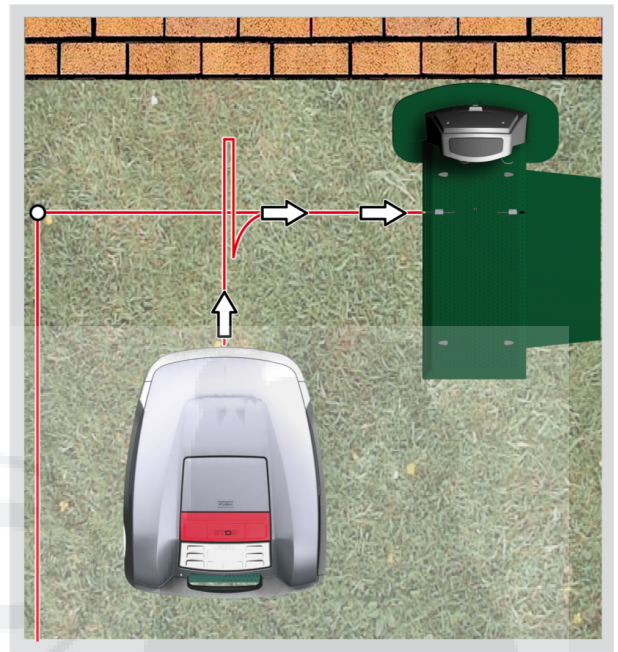

20.3.9 Display after the calibration movement

< Program Info >	
Total weekly	
mowing time xx:xx	
Abort	Confirm



Commissioning
completed
Mowing program is acti

Following calibration, the [Total weekly mowing time] window is displayed over the program information.

Confirm this display information with the [multifunction key right], then calibration is complete.

⇒ The mowing program is active, the battery is charged.

After calibration has been completed, the Robolinho® 3000 can be used for mowing with the factory-set mowing times without further programming.

The following mowing times are factory-set: Mon - Fri: 08:00 - 12:00 and Mon - Fri: 14:00 - 18:00.

20.4 Checking the cable laying

1. Place the Robolinho® 3000 about 1 metre in front of the boundary cable.
2. Press the [HOME key], the Robolinho® 3000 moves along the boundary cable back towards the base station.
3. In case of collisions or if the boundary cable is laid too close, the Robolinho® 3000 will cancel its movement.
4. Rectify the error, place the Robolinho® 3000 about 1 m in front of the boundary cable once again and press the [HOME key] a second time.



Pressing the [HOME key] deactivates the mowing day. Pressing the [START key] activates the mowing day and starts the mowing procedure.

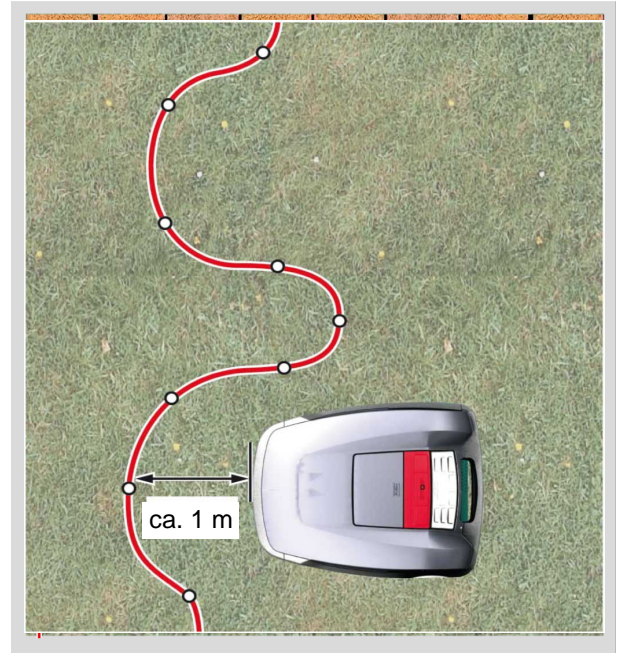

20.4.1 If the error message

1. Unplug the transformer.
2. Repair cable.
3. Transformer reconnect to the power grid.



21 Programming

21.1 Overview of main menu

The main menu of the Robolinho® 3000 is divided up into the following submenus:

- Program menu
- Setting menu
- Information menu

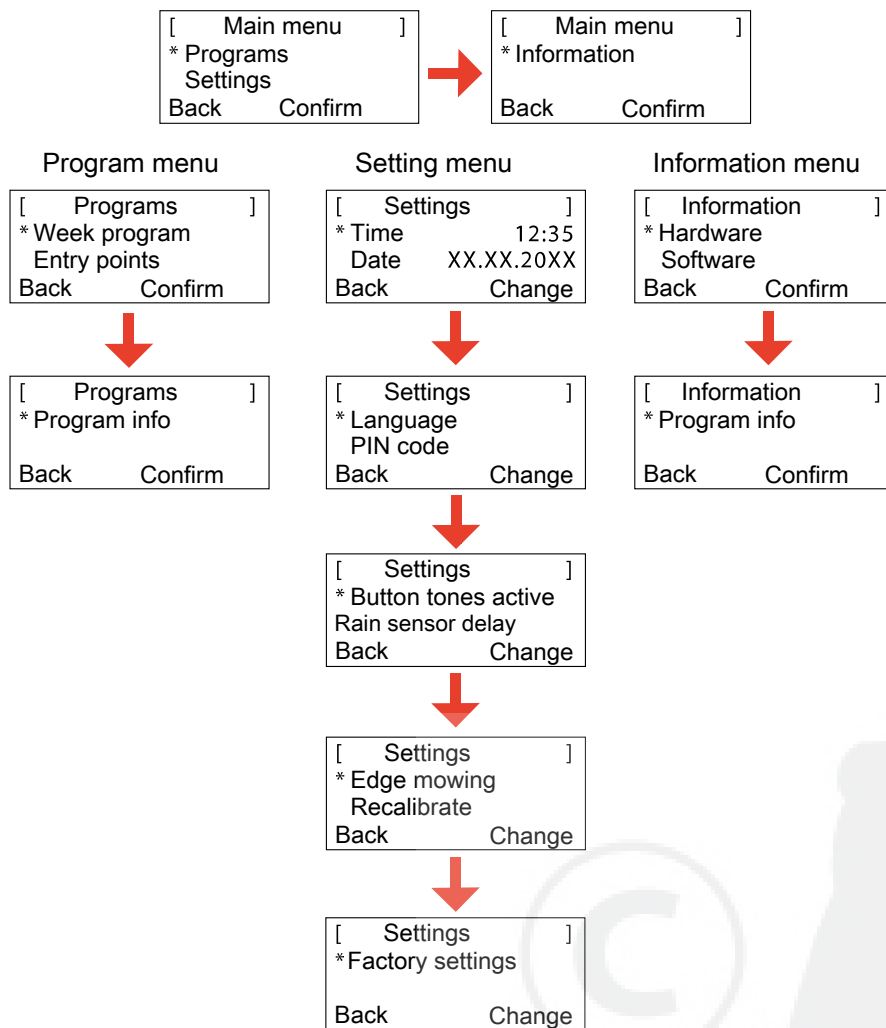

1. Start the Robolinho® 3000 as described.
2. Use the [up arrow key] or the [down arrow key] to select the required main menu.
 - ⇒ The star symbol to the left of the menu displays shows which selection is active.
3. Confirm the required main menu with the [multifunction key right].
 - ⇒ The corresponding sub-menus open.
4. Confirm the required application with the [multifunction key right].
 - ⇒ Change the sub-menu items if required.
5. Use the [multifunction key left] to return to the standard display.

21.2 Starting programming



In order to access the program menus of the Robolinho® 3000, it is necessary to perform this start procedure in all cases.

1. Switch on the Robolinho® 3000 by pressing the [ON/OFF key].
2. Enter PIN code, [Enter PIN code, page 59](#).
 - ⇒ The PIN code may also be the factory code if no different code was entered during calibration.
- After the PIN code has been entered, the [Next mowing] information appears, or the current mowing duration.
 - ⇒ The displayed mowing operation may be the factory setting, unless a new mowing operation has already been programmed.

13.06.2011	12:15
Next use	
Tues	18:00 - 19:00
Charge	80%

The Robolinho® 3000 is now ready for the programs and settings to be selected.

21.3 Selecting the menu



After switching on, it is possible to call up the main menu with the [menu key] (1).

21.4 Program menu

i Description of function keys, [Control panel, page 49](#)

- Make the settings in the week program.
- Program the entry points.
- Look at the program info, e.g. mowing program.

21.4.1 Selecting the program

Before programming, it is necessary to perform the start procedure, [Starting the Robolinho, page 72](#).

[Main menu]
*	Programs	
	Settings	
Back	Confirm	



[Programs]
*	Week program	
	Entry points	
Back	Confirm	

1. Use the [up arrow key] or the [down arrow key] to select the [Programs] menu item.
2. Confirm with the [multifunction key right].
3. Select the required programs and confirm with the [display key right].

21.4.2 Setting the week program

In the week program, the days of the week and the times are set when the Robolinho® 3000 should mow automatically.

- In the [All days] menu item (1), the Robolinho® 3000 mows at the set times every day.
 - ⇒ *The symbol [X] shows the currently active day of the week.*
 - In the [Day of week] menu item (2), the Robolinho® 3000 mows at the set times on the set day of the week.
1. Use the corresponding [arrow keys] to select the required menu item and confirm with the [display key] in each case.
 - ⇒ *Observe the mowing result and mow as long as necessary in order to obtain a well kept lawn.*

[All days] menu item

1. Select the [All days] menu item with the [arrow keys] and confirm with the [multifunction key right].
2. Press the [down arrow key] until [Change] is active.
3. Select the required menu item with the [arrow keys] and confirm with the [multifunction key right].

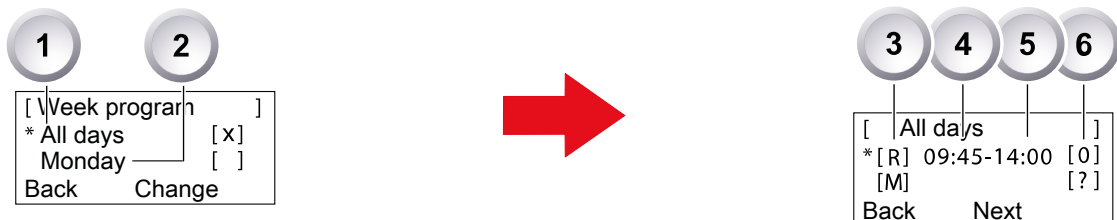

Explanation of symbols

(1)	Menu item	All days
(2)	Menu item	Day of week
(3)	[-]	Mowing window deactivated
	[R] Edge mowing	The Robolinho 3000 mows on the right along the boundary cable. After mowing the edges, the Robolinho 3000 continues mowing the marked-out area.
	[M]	Normal mowing
(4)	Start time	The Robolinho 3000 departs from the base station at the selected time for mowing.
(5)	End time	The Robolinho 3000 moves back to the base station at the selected time.
(6)	[0 - 9] Fixed entry point	The Robolinho 3000 departs from the selected entry point at the selected time for mowing. These entry points can be set.
	[?] Automatic entry point	The entry points are changed automatically (recommended setting).

21.4.3 Setting entry points

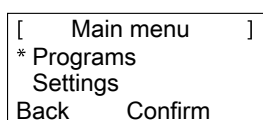

1. Use the [up arrow key] or the [down arrow key] to select the [Programs] menu item until the star symbol appears to the left of the menu item.
2. Confirm with the [multifunction key right].

21.4.4 Calling up entry points

```
[ Programs ]
Week program
* Entry points
Back Confirm
```



```
[ Entry points ]
* Point X1 at [020m]
Point X2 at [075m]
Back Confirm
```

1. Use the [up arrow key] or the [down arrow key] to select the [Entry points] menu item until the star symbol appears to the left of the menu item.
2. Confirm with the [multifunction key right].
3. Use the [up arrow key] or the [down arrow key] to select the [Point X*] menu item until the star symbol appears to the left of the menu item.
4. Set the required distances and set additional entry points if necessary.
5. Confirm with the [multifunction key right].
6. Press the [menu key] again to return to the main menu.



- By default, the first entry point is always 1 m to the right of the base station, and cannot be changed.
- By default, another 9 entry points are distributed along the overall length of the boundary cable (after the 1st edge mowing or complete loop movement).
- These entry points can be changed and programmed according to the size and composition of the mowing area.

21.4.5 Learning entry points

1. Press the [START/PAUSE key] to start the procedure.
 - ⇒ Follow the instructions on the display. [Learn entry points]
2. Set entry point X.
3. Position: Set Y with the [multifunction key right].



- No entry point is set.
- The loop length is measured and the start points are automatically distributed evenly over the length.
- The entry points can be adapted manually.

21.5 Setting menu

- Setting the time
- Setting the date
- Setting the language
- Setting the button tones
- Activating or deactivating the rain sensor
- Setting the display contrast
- Activating the setting lock
- Restoring factory settings

21.5.1 Setting the time

Selecting the program

Before programming, it is necessary to perform the start procedure, *.Starting the Robolinho, page 72*

```
[ Main menu ]
Programs
* Settings
Confirm
```



```
[ Enter time ]
24 hour format
7:00
Abort Confirm
```

1. Use the [up arrow key] or the [down arrow key] to select the [Programs] menu item.
2. Call up the [Enter time] menu.
3. Confirm with the [multifunction key right].
4. Select the required time with the [arrow keys] and confirm with the [multifunction key right].
5. Press the [menu key] twice to confirm all entries and return to the main menu.



The time is displayed in 24-hour format. When setting the time, it is necessary to select each individual digit until it flashes. Enter the time correctly, because further programming depends on the time. Confirm individual digits and use the arrow keys to select the next digit.

21.5.2 Setting the date

Selecting the program

Before programming, it is necessary to perform the start procedure, *.Starting the Robolinho, page 72*

```
[ Main menu ]
Programs
* Settings
Confirm
```



```
[ Enter the date ]
TT.MM.JJJJ
25.05.2012
Confirm
```

1. Select the required program item with the [arrow keys] and confirm with the [multifunction key right].
2. Call up the [Date] menu.

Setting the date

The date display is structured as follows:

- DD for the day.
- MM for the month.
- YYYY for the year.

1. Press the [up arrow key] briefly once. A [0] flashes at the first place in the display, or press the [down arrow key] once briefly. A [9] flashes at the first place in the display.
2. Confirm with the [multifunction key right].
 - ⇒ *Either use the [down arrow key] to count down from [9] or use the [up arrow key] to count up until the required digit is displayed.*
3. Enter the next required digits in the same way until the date has been fully set.
4. Confirm with the [multifunction key right].
5. Press the [menu key] twice to confirm all entries and return to the main menu.



Enter the date correctly, because further programming depends on the date. When entering the year (YYYY), it is only necessary to enter the last two digits because the first two 20XX are preset.

21.5.3 Setting the language

Before programming, it is necessary to perform the start procedure, *.Starting the Robolinho, page 72*

```
[ Main menu ]
Programs
* Settings
Confirm
```



```
[ Select language ]
English
Deutsch
Confirm
```

1. Use the [up arrow key] or the [down arrow key] to select the [Programs] menu item.
2. Call up the [Language] menu.
3. Confirm with the [multifunction key right].

4. Use the corresponding [arrow keys] to select the required language and confirm with the [multifunction key right].
 - ⇒ After confirming, the LCD display shows [Enter registration PIN].
5. Press the [menu key] twice to confirm all entries and return to the main menu.



The corresponding language only needs to be selected here during the initial start-up.

21.5.4 Selecting the program

Before programming, it is necessary to perform the start procedure, [Starting the Robolinho, page 72](#).

```
[ Main menu ]
* Programs
  Settings
Back   Confirm
```



```
[ Programs ]
* Week program
  Entry points
Back   Confirm
```

1. Use the [up arrow key] or the [down arrow key] to select the [Programs] menu item.
2. Confirm with the [multifunction key right].
3. Select the required programs and confirm with the [display key right].

21.5.5 Further setting possibilities

All other setting possibilities are always called up in the same way.

- After switching on, it is possible to call up the corresponding program menu with the [menu key].
- Select the [Settings] menu in the main menu.

21.5.6 Activate or deactivate the button tones

Before programming, it is necessary to perform the start procedure, [Starting the Robolinho, page 72](#)

```
[ Main menu ]
  Programs
* Settings
                Confirm
```



```
[ Settings ]
* Button tones active
  Rain sensor delay
Back   Change
```

1. Use the [up arrow key] or the [down arrow key] to select the [Programs] menu item.
2. Call up the [Button tones] menu.
3. Confirm with the [multifunction key right].
4. In the Settings sub-menu, select [Button tones].
5. Confirm with the [multifunction key right].
6. Activate or deactivate the button tones with the [multifunction key right].
7. Confirm the corresponding selection with the [menu key].
8. Press the [menu key] twice to confirm all entries and return to the main menu.

21.5.7 Activating or deactivating the rain sensor

1. In the Settings sub-menu, select [Rain sensor].
2. Confirm with the [multifunction key right].
3. Activate or deactivate the rain sensor with the [multifunction key right].
4. Confirm the selection with the [menu button] and return to the main menu.

21.5.8 Setting the rain sensor delay

1. In the Settings sub-menu, select [Rain sensor delay].
2. Confirm with the [multifunction key right].
3. Set the [Rain sensor delay].
4. Confirm the selection with the [menu button] and return to the main menu.

i The purpose of the [Rain sensor delay] function is to instruct the Robolinho® 3000 to move back out of the base station after a time delay, after it has returned to the base station.

21.5.9 Changing the display contrast

1. In the Settings sub-menu, select [Display contrast].
2. Select [Display contrast] with the [arrow keys] and confirm with the [multifunction key right].
3. Confirm the selection with the [menu button] and return to the main menu.

21.5.10 Restoring factory settings

1. In the Settings sub-menu, select [Factory settings].
2. Enter the PIN code again and confirm.
3. Confirm the selection with the [menu button] and return to the main menu.

21.6 Information menu

The Information menu is used for calling up various information such as software status, hardware status and current settings. No settings can be made in this menu.

- Product name
- Year of manufacture
- Number of operating hours
- Serial number
- Distance covered
- Software status with version number

21.6.1 Selecting the program

Before programming, it is necessary to perform the start procedure, *Starting the Robolinho, page 72*.

[Main menu]
* Programs
Settings
Back Confirm



[Main menu]
* Information
Back Confirm

1. Use the [up arrow key] or the [down arrow key] to select the [Programs] menu item.
2. Confirm with the [multifunction key right].

21.6.2 Call up hardware / software information

[Information]
* Hardware
Software
Back Confirm

[Hardware]
AL-KO automatic lawnmower
Manufacture 2012
Back

[Software]
Version V1.23.5
Back

Menu item:
[Hardware or software]

Display: Machine data,
operating hours, serial number

Display:
Software version number

1. Use the [up arrow key] or the [down arrow key] to select the [Hardware or software] menu item.
2. Confirm with the [multifunction key right].
3. Call up the corresponding hardware or software information.
4. Use the [multifunction key left] to return to the main menu.

21.7 Program information

[Program info]
Mon: 10:00 - 14:00
Thu: 18:00 - 19:00
Back

13.03.2012 12:15
Next mowing
Tue 18:00 - 19:00
Battery charge level 80%

[Program info]
Total weekly
mowing time 0:00
Back

Display: total set mowing time in
the week

Display: next day with a mowing
procedure

Display: total set number of
mowing hours

21.8 Faults

[Fault]
XX.XX.20XX	13:15	
CN007: No loop signal		
	OK	

Display:

Date, time and fault code with fault message.



22 Mowing

22.1 Safety instructions

- Keep the PIN code and PUK code where they cannot be accessed by unauthorised people.
- The PIN code can be changed by the owner.
- The PUK code can be secured by registering on our website:
⇒ <http://robozinho.al-ko.com>
- If the PIN code is entered incorrectly three times, it will be necessary to enter a PUK code.
- If the wrong PUK code is entered, the Roboline™ R30 will have to be sent in for it to be unlocked.
- Regularly check the Roboline™ R30 and the base station for damage.
- Have damaged parts and batteries replaced or repaired by an BRILL dealer, technician or service partner.

22.2 Setting the cutting height



The cutting height varies in the range from 3 - 6 cm lawn height. The cutting height can be adjusted in five steps of 6 mm each.

Open the cover

1. Press item (1).
⇒ Cover (2) is unlocked and can be opened upwards.

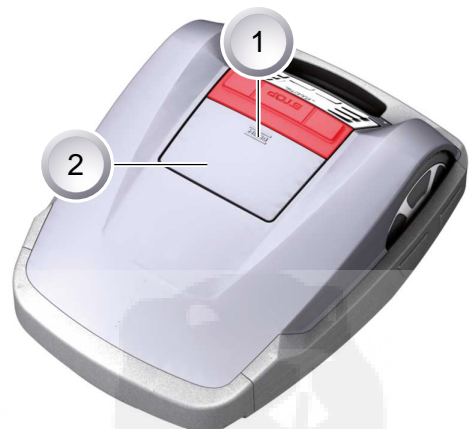

Setting the cutting height

1. Open lever (2) and turn it a quarter turn clockwise in the direction of [lock symbol opened] (1) (see also the quick info in the Robolino® 3000).
⇒ The cutting height adjustment is unlocked.
2. Pull lever upwards.
⇒ Lawn cutting height is increased.
3. Push lever downwards.
⇒ Lawn cutting height is reduced.
4. Subsequently: Turn lever a quarter turn anti-clockwise in the direction of [lock symbol closed] and engage.
⇒ Cutting height adjustment is locked.
5. Fold lever down and close the cover.

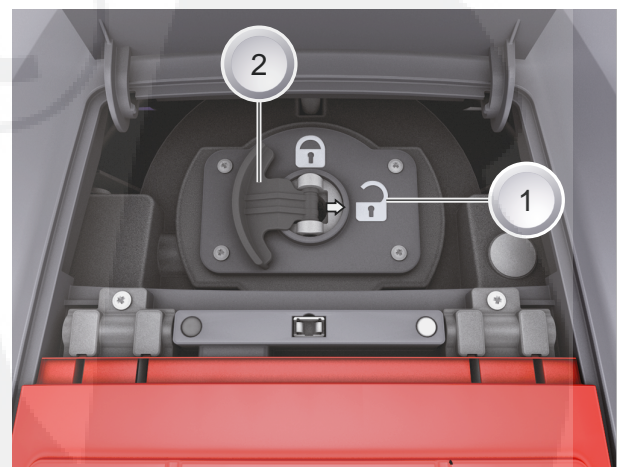

22.3 Starting the Robolinho

1. Switch on the Robolinho® 3000 by pressing the [ON/OFF key].
2. Enter PIN code, *Enter PIN code, page 59*.
 - ⇒ *After the PIN code has been entered, the [Next mowing] information appears. The Robolinho® 3000 is now ready for mowing.*

13.06.2011	12:15
Next use	
Tues	18:00 - 19:00
Charge	80%

The Robolinho® 3000 starts automatically when the next mowing window is reached.

25.05.2012	09:48
! Warning !	
Drive starts	
Charge	92%

Press the [START/PAUSE key] to start the mowing procedure immediately.

⇒ *The [Warning drive starting] display flashes and a signal sounds.*

22.4 Mowing tips

- Cutting height at a constant 3 - 5 cm, do not mow off more than half of the lawn height.
- Adjust the mowing times accordingly.
- If the motor speed drops noticeably because of thick grass, increase the cutting height and mow in several passes.



To allow the performance of the Robolinho® 3000 to be exploited to the full, we recommend having the Battery lawnmower mow the lawn during cool times of the day or at night.



23 Maintenance and care



CAUTION!

Injuries due to the cutting blades!

- Always switch off the Robolinho® 3000 at the [ON/OFF key] before starting maintenance and repair work.
- Disconnect the transformer of the base station from the mains.
- Always wear working gloves when carrying out maintenance and care jobs on the blade system!



CAUTION!

Damage to the electrical/electronic system by incorrect cleaning!

Do not clean the Robolinho® 3000 with a high-pressure cleaner or under running water. Water penetration can cause irreparable damage to the switch, battery and circuit boards.

23.1 Cleaning

1. Once a week, clean the Lawnmower thoroughly with a hand brush or a cloth, and use care spray if necessary.
 - ⇒ Contamination can impair the function of the machine if not removed.
2. Once a week, check the cutting blades for damage.

23.2 Cleaning the chassis

1. Thoroughly clean grass catcher (1) and guide (2) using a hand brush or a cloth.



23.3 Checking contacts

1. Clean the contact surfaces (1) on Lawnmover with a cloth if necessary.



Charring on the contact surfaces indicates a poor charging contact.

⇒ Bend the springs on the base station outwards.



23.4 Checking the base station

1. Disconnect the transformer mains plug.
2. Clean the contacts (1) on the base station using a cloth if necessary.
3. Push the contacts towards the base station and release.

⇒ *The contacts must spring back into the initial position.*



If the contacts do not spring back into the initial system, have them checked by an AL-KO dealer, technician or service partner, and renewed if necessary.

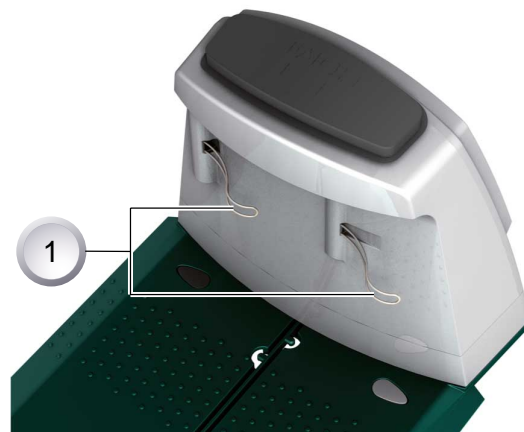

23.5 Check the rollers can move freely

1. Once a week, thoroughly clean the area around the rollers (1) with a hand brush or cloth.
2. Check the rollers can move and steer freely.

⇒ *If the rollers do not move freely, they must be freed up or renewed.*



23.6 Renewing the cutting blade

1. Put down the automatic lawnmower with the cutting blades pointing upwards.
2. Unscrew the screws (1) with a 5.5 mm spanner.
3. Pull the cutting blade (2) out of the blade seat.
4. Clean the blade seat with a soft brush.
5. Insert a new blade and screw it tight with the screws.

⇒ *As a rule, the clearer blades (3) do not need to be renewed.*

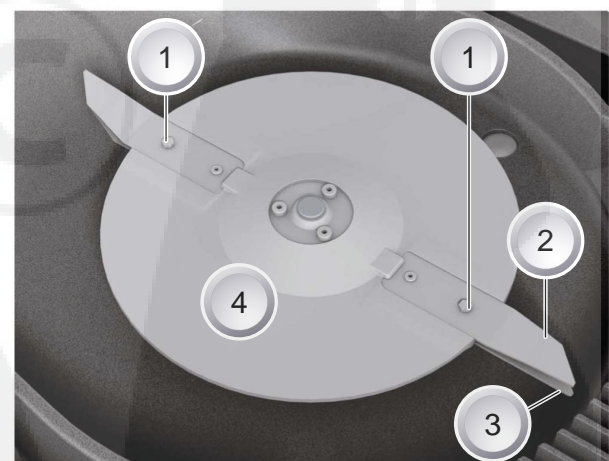

In case of stubborn dirt that cannot be removed with a brush, the blade plate (4) must be renewed because an imbalance can lead to increased wear and malfunctions.

Never use water to spray dirt off the Robolinho!

**CAUTION!****Damage due to an incorrect repair!**

If cutting blades are damaged and bent, they are not allowed to be straightened.

23.7 Renewing the transformer fuse

1. Disconnect the transformer mains plug.
2. Using a fl at-blade screwdriver, carefully press in bayonet lock (1) at the same time as opening anticlockwise.

⇒ *Bayonet lock springs out slightly.*

3. Renew the fuse and close bayonet lock by turning clockwise with the fl at-blade screwdriver.

**CAUTION!****Danger of fire due to fitting an incorrect fuse or jumpering the fuse.**

Always use a fuse with the same amp rating. Never jumper the fuse.

23.8 Battery status check

The battery status is shown on the display. Check the battery status after about 3 months.

Placing the Robolinho® 3000 onto the base station, switching on and reading off the battery status. If necessary, place it in the base station for charging.



The battery has been tested according to the UN handbook. Therefore, the battery is not subject to national and international regulations governing substances of concern, whether it is an individual part or has been installed in the device.

23.9 Charging the battery

- The integrated battery is partially charged on delivery. During normal operation, the battery of the Robolinho® 3000 is regularly recharged.
- A lengthy charging period is not necessary, because the Robolinho® 3000 can mow even when the battery is partially charged.
- When the battery charge reaches 0%, the Robolinho® 3000 automatically returns to its base station in order to charge the battery.
 - ⇒ *Interrupting charging does not damage the battery.*
- The base station is equipped with an electronic control unit with a monitoring function. This automatically terminates the charging procedure when a 100% charge status is reached.
- The battery status is shown on the display.
- Make sure the charging contacts of the base station have adequate contact with the contact surfaces on the Robolinho® 3000.
- The temperature range for charging should be between 0 and 40 °C.
- The built in protection circuit prevents the battery from being charged at temperatures above 45°C, in order to prevent irreparable damage to the battery.
- If the operating time of the battery is reduced in spite of it being fully charged, have the battery replaced by a new genuine battery. This task should be carried out by an AL-KO dealer, technician or service partner.

23.10 Exhaustively discharged battery

If the battery charge level has dropped below the threshold set by the manufacturer as a result of ageing or excessively long storage, this means it cannot be recharged any longer. Have the battery and the monitoring electronic control unit checked by an AL-KO dealer, technician or service partner, and renew it if necessary.

23.11 Storage

Before putting the robotic mower into storage for the winter, please make sure it is fully charged.

Then store in a dry, frost-free place.

23.12 Repairs



CAUTION!

Repair work may only be carried out by competent specialist workshops or our AL-KO Service Centres.



24 Troubleshooting

General

Error message	Possible cause	Solution
Low battery voltage	Boundary cable defective, automatic lawnmower does not find base station.	Check boundary cable for interruptions, if necessary have it tested by an AL-KO service partner.
	Battery exhausted.	Battery service life exceeded. Have battery renewed by an AL-KO service partner.
	Charging electronics faulty.	Have charging electronics renewed by an AL-KO service partner.
	Automatic lawnmower does not touch charging contacts.	<ul style="list-style-type: none"> ■ Put automatic lawnmower into base station and check if charging contacts make contact. ■ Have charging contacts checked and renewed by an AL-KO service partner.
Incorrect PIN code	PIN code has been entered incorrectly.	Enter correct PIN code. Three attempts are allowed, after which a PUK code must be entered.
Mowing result is uneven	Working time of automatic lawnmower is too short.	Programme longer working times.
	Mowing area too big.	Reduce mowing area.
	Ratio of cut height to tall grass is incorrect.	Set cutting height taller, then reduce in stages to required height.
	Cutting blades are blunt.	Renew cutting blades or have them sharpened by an AL-KO service partner; install with new screws.
	Grass is blocking rotation of cutting blade plate or motor shaft or is making it more difficult to rotate.	Remove grass and ensure that cutting blade plate can rotate freely.
Automatic lawnmower is mowing at wrong time	Time on automatic lawnmower or start and finish time for mowing must be set.	Set time.
Automatic lawnmower is vibrating	Imbalance on cutting blade or cutting blade drive.	Check and clean cutting blade and cutting blade plate, renew if necessary.

Fault code

Error message	Possible cause	Solution
CN001: Tilt sensor	<ul style="list-style-type: none"> ■ Max. tilt exceeded ■ Automatic lawnmower has been carried ■ Slope too steep 	Place automatic lawnmower on a flat surface and acknowledge fault.

Error message	Possible cause	Solution
CN002: Lift sensor	Cover has been deflected upwards by lifting or by a foreign body.	Remove foreign body.
CN005: Bumper deflected	Automatic lawnmower has encountered an obstacle and cannot free itself (collision close to base station).	
CN007: No loop signal	No loop signal.	<ul style="list-style-type: none"> ■ Check base station power supply ■ Check loop ■ Disconnect and reconnect transformer
CN008: Loop signal weak	Loop signal weak.	<ul style="list-style-type: none"> ■ Check base station power supply ■ Check loop, it has possibly been buried too deep ■ Disconnect and reconnect transformer
CN010: Bad position	Automatic lawnmower is outside loop.	<ul style="list-style-type: none"> ■ Place automatic lawnmower in mowing area ■ Loop crossed-over
CN011: Escaped robot	Automatic lawnmower has left field.	Check routing of loop (curves, obstacles, etc.)
CN012: Cal: no loop	Fault during calibration, automatic lawnmower could not find loop.	<ul style="list-style-type: none"> ■ Place automatic lawnmower at right angles to loop, automatic lawnmower must be able to drive over loop ■ Check base station power supply ■ Check loop ■ Disconnect and reconnect transformer
CN015: Cal: outside	Fault during calibration.	<ul style="list-style-type: none"> ■ Place automatic lawnmower at right angles to loop, automatic lawnmower must be able to drive over loop ■ Check base station power supply ■ Check loop ■ Disconnect and reconnect transformer ■ Loop cable crossed-over
CN017: Cal: signal weak	Fault during calibration, loop signal too weak.	<ul style="list-style-type: none"> ■ Check base station power supply ■ Check loop

Error message	Possible cause	Solution
		<ul style="list-style-type: none"> ■ Disconnect and reconnect transformer
CN018: Cal: Collision	Fault during calibration, collision	Remove obstacle
CN038: Battery	Battery flat.	<ul style="list-style-type: none"> ■ Check base station for obstacles ■ Check base station charging contacts ■ Loop too long, too many islands ■ Automatic lawnmower has got stuck
	Boundary cable defective, automatic lawnmower does not find base station.	Check boundary cable for interruptions, if necessary have it tested by an AL-KO service partner.
	Battery exhausted.	Battery service life exceeded. Have battery renewed by an AL-KO service partner.
	Charging electronics faulty.	Have charging electronics renewed by an AL-KO service partner.
	Automatic lawnmower does not touch charging contacts.	<ul style="list-style-type: none"> ■ Put automatic lawnmower into base station and check if charging contacts make contact ■ Have charging contacts checked and renewed by an AL-KO service partner
CN045: Current sft WL	Excess current draw by left drive motor.	Check drive for blockage.
CN046: Current hrd WL		
CN065: Current sft WR	Excess current draw by right drive motor.	Check drive for blockage.
CN066: Current hrd WR		
CN099: Recov escape	Automatic fault rectification not possible.	Rectify fault manually.
	Automatic lawnmower is outside loop.	Place automatic lawnmower in base station.
CN104: Battery over heating	Battery overheating - battery temperature above 60 °C, not discharging possible	Emergency switch-off by monitoring electronic control unit. Do not place automatic lawnmower on base station. Switch off automatic lawnmower and let battery cool down.
CN107: Battery too cold	Battery too cold < 0 °C.	Operation not possible.
CN110: Blade motor over heating	Overheated mowing motor, temperature > 80 °C	Switch off automatic lawnmower and let it cool down. If this reoccurs, have automatic lawnmower checked by an AL-KO service partner.

Error message	Possible cause	Solution
CN119: R-Bumper deflected	Automatic lawnmower has encountered an obstacle and cannot move clear for safety reasons, e.g. collisions close to base station.	Remove obstacle and acknowledge fault message.
CN120: L-Bumper deflected	Automatic lawnmower has encountered an obstacle and cannot move clear for safety reasons, e.g. collisions close to base station.	Remove obstacle and acknowledge fault message.
CN125: Bumper escape	Leaves field when reversing after encountering an obstacle.	Cover sticking or bumper defective, remove obstacle.
CN128: Recov Impossible	Obstacle encountered or outside loop -> reversing not possible, automatic lawnmower cannot free itself.	Remove obstacle, check cover deflection.
CN129: Blocked WL	Left wheel motor blocked.	Remove blockage.
CN130: Blocked WR	Right wheel motor blocked.	Remove blockage.



In the case of faults that are not listed in this table, or faults that you cannot rectify without assistance, please contact our customer service department.

24.1 Examples of fault messages

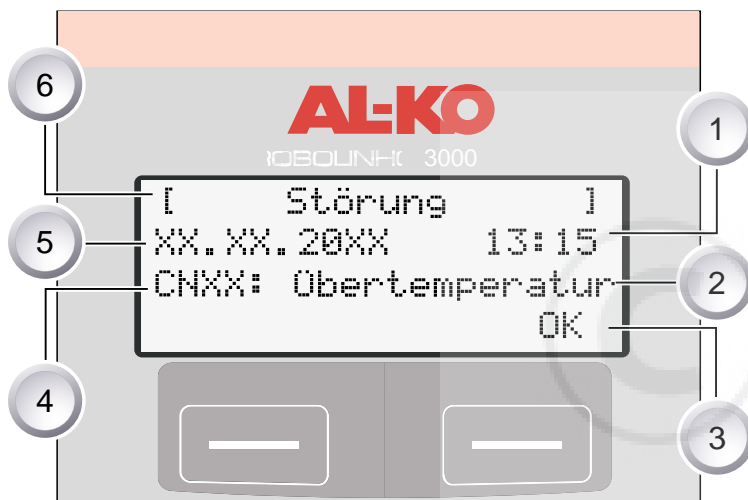

1	Time	4	Fault code
2	Fault message	5	Date
3	Actuation panel	6	Malfunction display

The battery and mowing motor in the Robolinho® 3000 are monitored by an electronic control unit, which displays malfunctions and the status on the LCD display of the Robolinho® 3000.

If this display reappears, do not continue operation. Have the Robolinho® 3000 checked by your AL-KO dealer, technician or service partner.

25 Technical data

Robolino® 3000 data	
Length in mm	600
Width in mm	490
Height in mm	245
Weight in kg	approx. 8
Mowing system	electrical with 2 cutting blades
Motor cutting blades rpm	3200 - 3600
Cutting height in mm	30 - 60
Cutting height adjustment 5-stage in mm	6 mm per stage
Cutting width in mm	300
Max. area to be mowed in m ²	approx. 1200
Max. angle of inclination of lawn area in %	35
Distance from limiting cable to limiting line (wall/hedge)	approx. 15 cm

Base station / transformer data		Secondary
Base station connection voltage	230 V 16 A 50 Hz	Contacts
max. charge voltage in volts	29.4 V	27 V AC / 2.2 A
Current in amps	4 A	60 VA
Working power in watts	30 - 60	

Noise emission	
Volume measured in dB(A)	63
Volume guaranteed in dB(A)	69

Battery	
voltage in V	25.2
Capacity in Ah	3 Ah
Energy	73 Wh - 76 Wh
Maximum charging temperature in degrees Celsius	40 °C

26 Appendix

26.1 Warranty

If any material or manufacturing defects are found during the statutory customer protection period, we will either repair or replace the equipment, whichever we consider the more appropriate. This statutory period may vary according to the legislation in force in the country where the equipment was purchased.

Our warranty is valid only if:

- The equipment has been used properly
- The operating instructions have been followed
- Genuine replacement parts have been used

The warranty is no longer valid if:

- The equipment has been tampered with
- Technical modifications have been made
- The equipment was not used for its intended purpose

The following are not covered by warranty:

- Paint damage due to normal wear
- Wear parts identified by a border [xxx xxx (x)] on the spare parts list
- Combustion motors (these are covered by a separate warranty from the manufacturer concerned)

The warranty period begins on the purchase by the first end user. Decisive is the date on the receipt. To make a claim under warranty, please take this statement of warranty and proof of purchase to the nearest authorised customer service centre. This warranty does not affect the usual statutory rights of the customer relative to the seller.

26.2 EC declaration of conformity

We hereby declare that this product in the form in which it is marketed by us complies with requirements of the harmonized EC directives, EC safety standards and the product-specific standards.

Product

Robot lawnmower

Type

Robolinho 3000

Manufacturer

AL-KO Kober GmbH

Hauptstraße 51

A-8742 Obdach

Authorised representative

Anton Eberle

Ichenhauser Str. 14

D-89359 Kötzing

Serial number

G 1501 500

Obdach, 20.03.2012



Ing. Klaus Rainer, Managing Director

EC Directives

2006/42/EG, 2004/108/EG

2002/95/EG, 2002/96/EG

2003/108/EG, 2006/95/EG

Harmonised standards

EN 61000-6-1, EN 61000-3-2/3

EN 60335-1, EN 60335-2-15

EN 55014-1, EN 55014-2

Notice



27 ETK Robolinho 3000

Art.Nr. 119 356

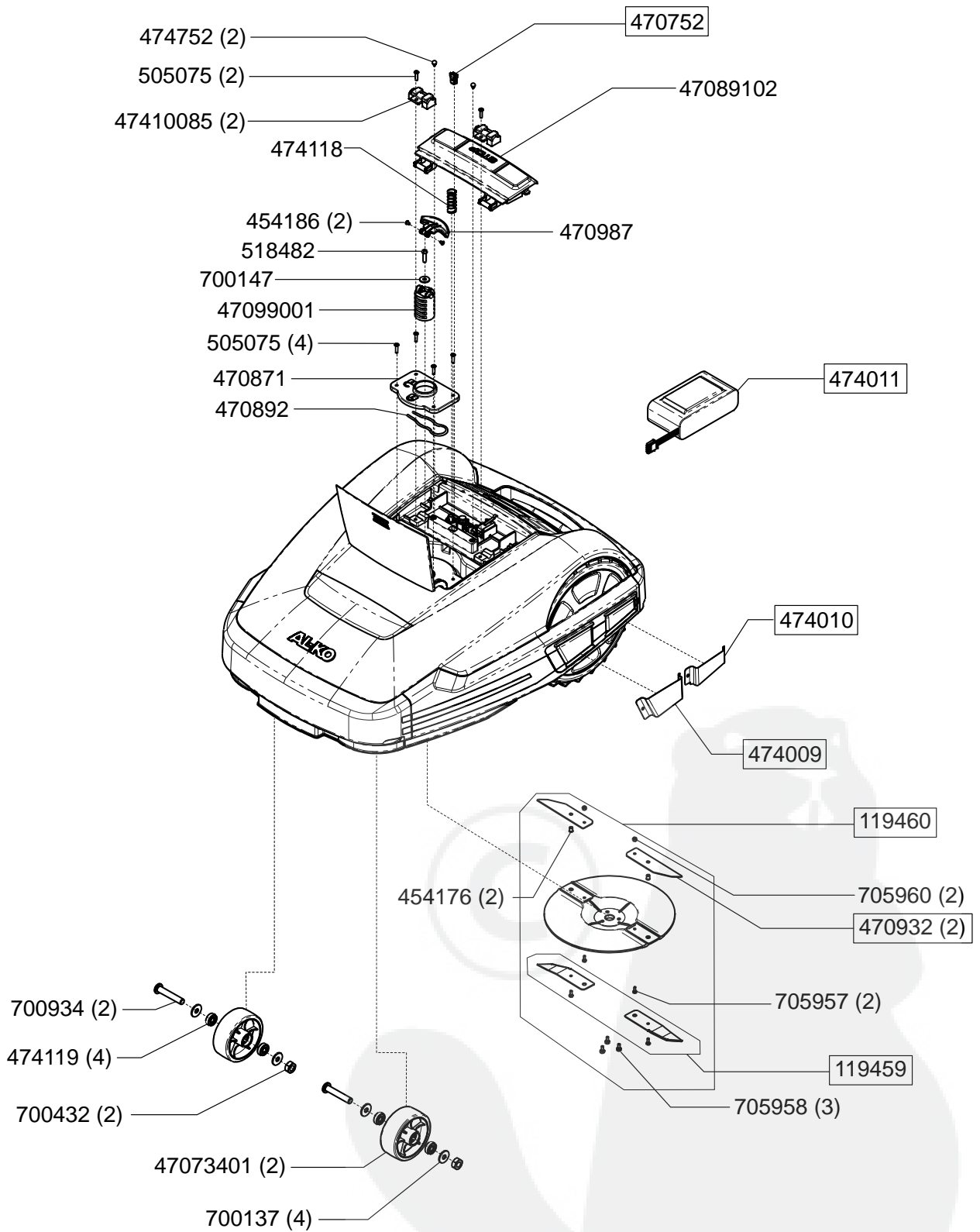

ETK Robolino 3000

Art.Nr. 119 356

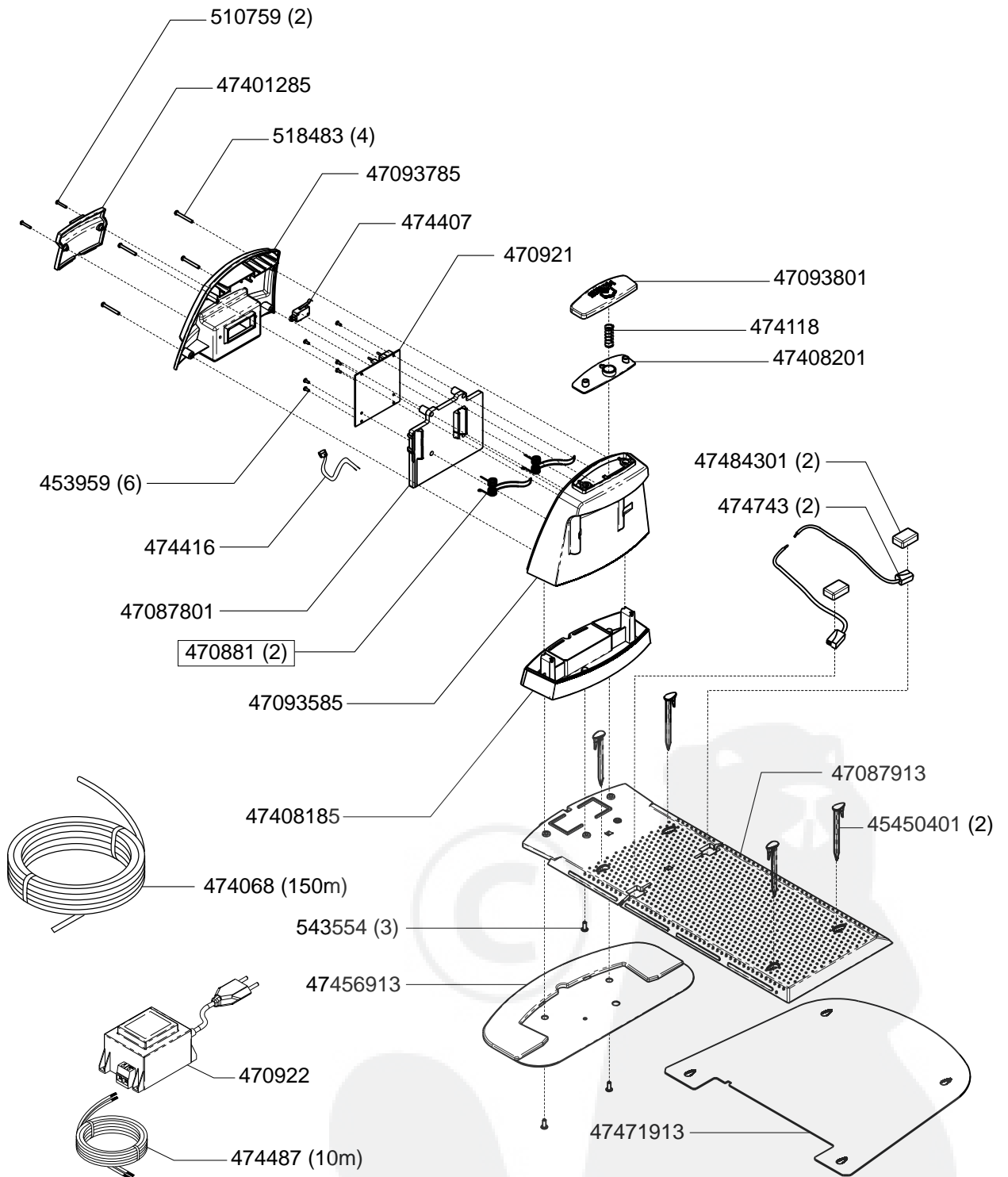

Notice





Country	Company	Telephone	Fax
A	AL-KO Kober Ges.m.b.H.	(+43) 35 78 / 2 515100	(+43) 35 78 / 2515 30
AUS	AL-KO International PTY. LTD	(+61) 3 / 97 67- 3700	(+61) 3 / 97 67- 3799
B / L	Eurogarden NV	(+32)16 / 80 54 27	(+32)16 /80 54 25
BG	Valerii S&M Group SJ	(+359) 2 942 34 02	(+359) 2 942 34 10
CH	AL-KO Kober AG	(+41) 56 / 418 31 50	(+41) 56 / 418 31 60
CZ	AL-KO Kober Spol.sr.o.	(+420) 382 / 21 03 81	(+420) 382 / 21 27 82
D	AL-KO Geräte GmbH	(+49) 82 21/ 2 03 - 0	(+49) 82 21/ 2 03 -138
DK	AL-KO Ginge A/S	(+45) 98 82 10 00	(+45) 98 82 54 54
EST/LT/LV	AL-KO Kober SIA	(+371) 674 09 330	(+371) 678 07 018
F	AL-KO S.A.S.	(+33) 3 / 85 -76 35 40	(+33) 3 / 85 -76 35 88
GB	Rochford Garden Machinery Ltd.	(+44)19 63 / 82 80 50	(+44)19 63 / 82 80 52
H	AL-KO KFT	(+36) 29 / 53 70 50	(+36) 29 / 53 70 51
HR	Brun.ko.-prom d.o.o.	(+385) 1 3096 567	(+385) 1 3096 567
I	AL-KO Kober GmbH / SRL	(+39) 039 / 9 32 93 11	(+39) 039 / 9 32 93 90
IN	AGRO-COMMERCIAL	(+91) 33 2287 4206	(+91) 33 2287 4139
IQ	Gulistan Com	(+946) 750 450 80 64	
IRL	Cyril Johnston & Co. Ltd.	(+44) 2890 813 121	(+44) 2890 914 220
LY	ASHOFAN FOR AGRICULT. ACC.	(+218) 512 660 209	(+218) 512 660 209
MA	BADRA Sarl	(+212) 022 447 128	(+212) 022 447 130
MK	Techno Geneks	(+389) 2 255 18 01	(+389) 2 252 01 75
N	AL-KO GINGE A/S	(+47) 64 86 25 50	(+47) 64 86 25 54
NL	O.DE LEEUW GROENTECHNIEK	(+31) 38 / 444 6160	(+31) 38 / 444 6358
PL	AL-KO Kober z.o.o.	(+48) 61 / 8 16 19 25	(+48) 61 / 8 16 19 80
RO	OMNITECH Technology SRL	(+4) 021 326 36 72	(+4) 021 326 36 79
RUS	OOO AL-KO Kober	(+7) 499 / 168 87 18	(+7) 499 /966 00 - 00
RUS	AL-KO St. Petersburg GmbH	(+7) 8 12 / 4 46 10 75	(+7) 8 12 / 4 46 10 75
S	AL-KO Ginge Svenska AB	(+46) (0) 3157 35 80	(+46) (0) 3157 56 20
SK	AL-KO Kober Slovakia Spol.s.r.o.	(+421) 2 / 45 99 4112	(+421) 2 / 45 64 8117
SLO	Darko Opara s.p.	(+386) 1 722 58 50	(+386) 1 722 58 51
SRB	Agromarket d.o.o.	(+381) 34 308 000	(+381) 34 308 16
TR	ZIMAS A.S.	(+90) 232 4580586	(+90) 232 4572697
UA	TOV AL-KO Kober	(+380)44/4923396	(+380)44/4923397