

RASENTRAKTOREN
LAWN TRACTORS
Tracteurs de pelouse







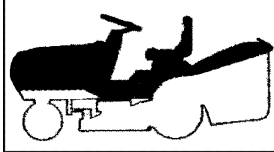
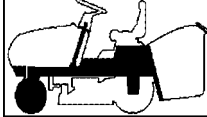

Modelle 2007

Crossover

74 / 13 H Hydro

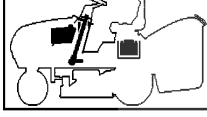
Art. 65054

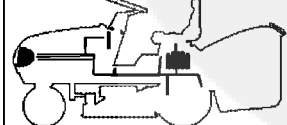
1	 <p>KARROSSERIE BODY CARROSSERIE</p>
2	 <p>RAHMENSATZ & LENKGETRIEBE CHASSIS & STEERING CHASSIS & BARRE DE DIRECTION</p>
3	 <p>GETRIEBE TRANSMISSION TRANSMISSION</p>
4	 <p>MOTOR ENGINE MOTEUR</p>
5	 <p>SCHNEIDWERK CUTTING PLATE PLATEAU DE COUPE</p>
6	 <p>TANK, BATTERIE & KOMPONENTEN TANK, BATTERY & COMPONENTS TANK, BATTERIE & COMPOSANTS</p>
7	 <p>GRASFANGSACK KPL. GRASS CATCHER ASSY. BAC COMPOSANTS</p>
8	 <p>ELEKTRIK 1 ELECTRIC 1 ELECTRIQUES 1</p>

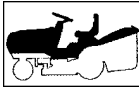

Crossover
74 / 13 Hydro
Art. 65054
 2007
 1/8

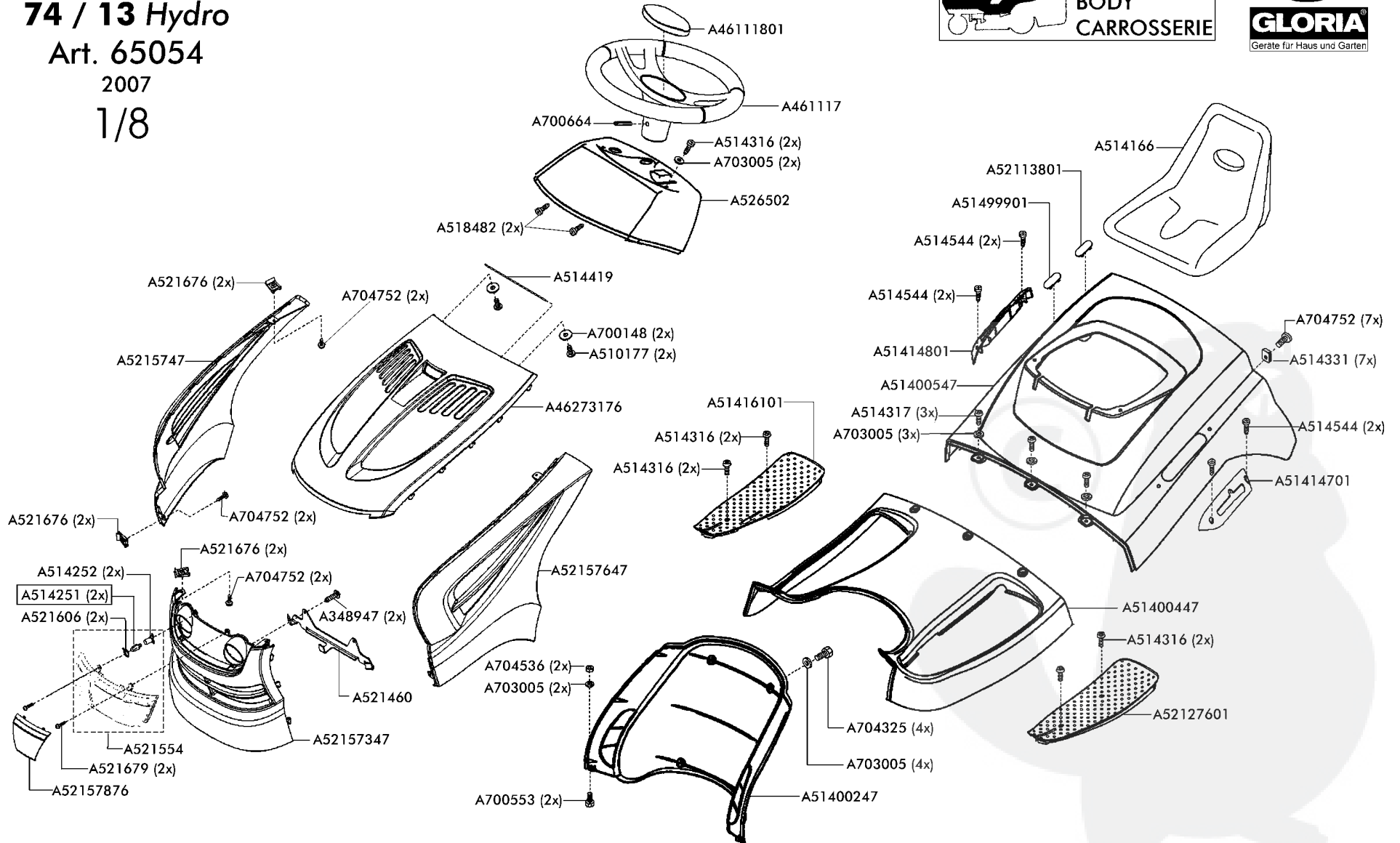
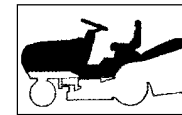

Technische Änderungen vorbehalten

2/22		RASENTRAKTOREN		 74 / 13 Hydro - Art. 65054 Modell 2007		 	
2007		LAWN TRACTORS					
Rev070601		Tracteurs de pelouse					
Bild Nr. REF.N° POS.N°	BEST.-NR. PART.-N° N° d. PIECE	BEZEICHNUNG	DESCRIPTION	DÉSIGNATION	Qty.		
1	A348947	SHR PT-KB 60X20 1442	Screw	VIS	2		
2	A461117	LENKRAD KPL	STEERING WHEEL	VOLANT	1		
3	A46111801	ABDECKKAPPE FÜR LENKRAD R9005	CAP	BOUCHON	1		
4	A46273176	OBERTEIL HAUBE BRILL R7016	ENGINE HOOD GREEN	CAPOT	1		
5	A510177	SHR PT-KB 60 X14 1411	Screw	VIS	2		
6	A51400247	KONSOLE MOTORHAUBE R6001	DASHBOARD	TABLEAU DE BORD	1		
7	A51400447	MITTELKONSOLE VORNE R6001	FRONT CENTRAL DASHBOARD	SUPPORT TABLEAU CENTR.	1		
8	A51400547	MITTELKONSOLE HINTEN R6001	MIDDLE DASHBOARD	TABLEAU CENTR.	1		
9	A51414701	ABDECKUNG HYDROSTART R9005	COVER	CAPOT	1		
10	A51414801	ABDECKUNG HÖHENVERSTELLUNG R9005	COVER	CAPOT	1		
11	A51416101	TRITTPLATTE RECHTS R9005	RIGHT FOOTBOARD	MARCHEPIED DROITE	1		
12	A514166	SITZ SEAT 1	SEAT	SIEGE	1		
13	A514251	LAMPE XENON 6W	FARILAMP FOR LIGHTS	LAMPE POUR PHARES	2		
14	A514252	LAMPENFASSUNG TRAKTOR	LAMP HOLDER	DOUILLE DE LAMPE	2		
15	A514316	SCHRAUBE SFS-TAPT 6X12 2019 A3R	SCREW	VIS	2		
16	A514317	SCHR.SFS.TAPT6X16 2019 A3R	Screw	VIS	3		
17	A514326	PASSFEDER 1/4"X1/4"X1 3/4	Key	CLAVETTE	6		
18	A514331	BLECHMUTTER 4.8 FORM 1 VZ	Hex.Nut	ECROU	7		
19	A514419	FEDERSTAHL DRAHT VERZ	SPRING WIRE	BARRE	1		
20	A514544	SCHR.PT-KB60X30 1411A3R	Screw	VIS	4		
21	A51499901	ABDECKKAPPE MITTELKONSOLE R9005	COVER PLATE	COUVRE	1		
22	A518482	SCHR.PT-KB50X18 1411	Screw	VIS	2		
23	A52113801	ABDECKKAPPE MITTELKONSOLE R9005	COVER	COUVRE	1		
24	A52127601	TRITTPLATTE LINKS R9005	LEFT FOOTBOARD	MARCHEPIED GAUCHE	1		
25	A521460	SCHARNIERBLECH HAUBE	CLAMP SUPPORT	ETRIER SUPPORT	1		
26	A521554	SCHEINWERFER KPL HAUBE-4 XENON 6W	GRILL	PANNEAU	1		
27	A52157347	FRONTTEIL HAUBE R6001	Front cover	FRONT	1		
28	A52157547	SEITENTEIL RECHTS HAUBE R6001	Side cover right	CAPOT DROITE	1		
29	A52157647	SEITENTEIL LINKS HAUBE R6001	Side cover left	CAPOT GAUCHE	1		
30	A52157876	ABDECKUNG VORNE	Front hood	CAPOT A L'AVANT	1		
31	A521606	SCHLAUCHKLEMME "REFLEKTOR"	Fastener	BORNE	2		
32	A521676	SCHNAPPMUTTER NU 0921	Nut	ECROU	6		
33	A521679	SCHR PT-KB 30X12 WN 5452	Screw	VIS	2		
34	A526502	BEDIENKONSOLE TAMP Y-SILBER	DASHBOARD	TABLEAU DE BORD	1		
35	A700148	SHB 6,4 9021-ST VZ	Washer	RONDELLE	2		
36	A700553	SHR 6X 40 933- 8.8VZ	Screw	VIS	2		
37	A700664	HUEL SPAN 8 X 60 1481	BUSH	DOUILLE	1		
38	A703005	SHB A6.4 A3S 9021ers.d.703005	Washer	RONDELLE	11		
39	A704325	SHR 6X 40 933- 8.8A3S	Screw	VIS	4		
40	A704536	MU 6KT 6 985- 8 A3B	Hex.Nut	ECROU	2		
41	A704752	SHR KO 4,8X16 ZZ-C7981VZ	Screw	VIS	11		

4/22		RASENTRAKTOREN		 RAHMENSATZ & LENKGETRIEBE CHASSIS & STEERING CHASSIS & BARRE DE DIRECTION		Crossover		74 / 13 Hydro - Art. 65054		1/3 	
2007		LAWN TRACTORS				Modell 2007					
Rev070601		Tracteurs de pelouse									
Bild Nr. REF.N° POS.N°	BEST.-NR. PART-N° N° d. PIECE	BEZEICHNUNG	DESCRIPTION	DÉSIGNATION	Qty.						
1	A2042850001	DRUCKKNOPF F. BR-HEBEL T	PRESSURE KNOP	BOUTON DE PRESSION	1						
2	A2045480006	FEDER F. HANDGRIF T	SPRING RIGHT	RESSORT DROITE	1						
3	A302231	KAPPE R9005	COVER	COUVRE	1						
4	A348988	MUTTER SIC- BIW M 8 A3C- 8 MITTELGESICH	NUT	ECROU	1						
5	A375725	HANDGRIF HOENENVERST. T	HANDLE	POIGNEE	1						
6	A450263	BUCHSE TRAKTOR VORDERRAD	BRASS	COUSSINET	2						
7	A46110530	LENKSEGMENT GESCHW VERZ	SEGMENT	SEGMENT GUIDER	1						
8	A46110730	LENKHEBEL 2 TEILIG UNTEN VERZ	LOWER STEERING ARM	LEVIER GUIDER EN BAS	1						
9	A46110830	LENKHEBEL 2 TEILIG OBEN VERZ	UPPER STEERING ARM	LEVIER GUIDER EN HAUT	1						
10	A461109	BUNDBUCHSE LENKUNG	COLLAR BUSH	DOUILLE	1						
11	A461110	BUCHSE	BUSH	DOILLE	1						
12	A46111130	SCHUBSTANGE VERZ	STEERING ROD	BARRE DE DIRECTION	1						
13	A461231	MUTTER SIC- BIW M10 A3B- 8	NUT	ECROU	2						
14	A461289	ABDECKKAPPE"TRAKTOR"	HUB COVER	COUVRE MOYEU	2						
15	A461290	SCHEIBE 42MM FÜR TRAKTOR	WASHER	RONDELLE	2						
16	A461497	WIPPE FÜR KUPPLUNG FAHRANTRIEB	SUPPORT	SUPPORT	1						
17	A461498	ZUGSTANGE FÜR KUPPLUNG FAHRANTRIEB	TENSION ROD	BARRE	1						
18	A461499	ROHR FÜR KUPPLUNG FAHRANTRIEB	TUBE	TUBE	1						
19	A461500	ZUGFEDER FÜR KUPPLUNG FAHRANTRIEB	TENSION SPRING	RESSORT DE TRACTION	1						
20	A461501	LAGERSCHEIBE FÜR KUPPLUNG FAHRANTRIEB	DISC	RONDELLE	2						
21	A461502	KUGELFÜHRUNG FÜR KUPPLUNG FAHRANTR	GUIDE	GUIDE	1						
22	A461537	MANTEL FÜR REIFEN 13X6,00-6 2PR	TIRE 13X6,00-6 2PR	PNEU 13X6,00-6 2PR	2						
23	A46189340	STOSSSTANGE 30 MM LANG GESC R9006 BRILL	PUSH ROD	PAE-CHOCS	1						
24	A504729	SCHNELLBEFESTIGER 5SXN26	STARLOCK	STARLOCK	1						
25	A510566	SCHNELLBEFESTIGER 8SXN26	CROWN FASTENER	FIXATEUR A COURONNE	5						
26	A51404130	SPURSTANGE VERZ	STEERING ROD	BARRE DE DIRECTION	1						
27	A514042	BUCHSE-ACHSSCHENKEL	BUSH	DOUILLE	4						
28	A51405101	RAHMEN GESCHWEISST R9005	CHASSIS	CHASSIS	1						
29	A51406701	PEDALAUFLAGE BREMSE UND KUPPL. R9005	SUPPORT	SUPPORT	1						
30	A51406830	PEDAL RECHTS VERZ	PEDAL RIGHT	PEDAL DROITE	1						
31	A51414130	LAGERSTANGE SITZKONSOLE VERZ	ROD	BARRE	1						
32	A51416801	PEDALAUFLAGE MÄHANTRIEB R9005	SUPPORT	SUPPORT	1						
33	A514224	HEBEL KPL.HÖHENVERSTELLUNG	LEVER CPL	LEVIER CPL	1						
34	A514230	HÜLSE	BUSH	DOUILLE	1						
35	A514295	DREHFEDER LINKS	TORSION SPRING LEFT	TORSSION DE RESSORT GAUCHE	1						
36	A514299	PENDELANSCHLAG	BLOCK	BUTEE	4						
37	A514307	DRUCKFEDER FÜR SITZ	PRESSURE SPRING	RESSORT A PRESSION	2						

5/22		RASENTRAKTOREN		 RAHMENSATZ & LENKGETRIEBE CHASSIS & STEERING CHASSIS & BARRE DE DIRECTION		Crossover		74 / 13 Hydro - Art. 65054		2/3		 	
2007		LAWN TRACTORS				Modell 2007							
Rev070601		Tracteurs de pelouse											
Bild Nr. REF.N° POS.N°	BEST.-NR. PART.-N° N° d. PIECE	BEZEICHNUNG	DESCRIPTION	DÉSIGNATION	Qty.								
38	A514316	SCHRAUBE SFS-TAPT 6X12 2019 A3R	SCREW	VIS	2								
39	A514327	DRUCKSCHALTER	PRESS SWITCH	INTERRUPTEUR À PRESSION	2								
40	A514346	ABDECKKAPPE D-35 RAL9005	COVER	COUVRE	2								
41	A51436030	LAGERBUCHSE-VORDERACHSE VERZ	BRASS	COUSSINET	1								
42	A514385	SCHALTERHALTER	SWITCH SUPPORT	SUPPORT INTERRUPTEUR	2								
43	A514386	DREHFEDER RECHTS	TORSION SPRING RIGHT	TORSSION DE RESSORT DROITE	1								
44	A51438730	DISTANZBUCHSE VERZ	SPACER	ENTRETOISE	1								
45	A514396	BÜGEL	CONNECTING PLATE	PAQUE DE CONNEXION	1								
46	A514410	FESTSTELLFEDER RECHTS	SPRING RIGHT	RESSORT DROITE	1								
47	A51442430	LAGERBOLZEN PEDAL VERZ.	PIN	PIVOT	2								
48	A51447701	PENDELACHSE GESCHW R9005	FLOATING AXLE	ABRE OSCILLANT	1								
49	A514701	WINKELGELENK CS16-M10+SIC	JOINT	JOINT	4								
50	A519076	ROHRSTOPFEN FÜR ROHR 30X2	PLUG	BOUCHON	2								
51	A521123	SCHEIBE D50X5 NACHARBEIT	WASHER	RONDELLE	1								
52	A521170	ACHSSCHENKEL LI.VZ.NEU ET	LEFT STUB AXLE	FUSEAU GAUCHE	1								
53	A521171	ACHSSCHENKEL RE.VZ.NEU ET	RIGHT STUB AXLE	FUSEAU DROITE	1								
54	A52118530	FUSSHEBEL GESCHW VERZ	DRIVE PEDAL	PEDALE TRANSMISSION	1								
55	A52118630	FIXIERUNG VERZ.	PLATE	PLAQUE	1								
56	A52118730	LAGERBOCK VERZ	BEARING BRACKET	CHEVALET SUPPORT	1								
57	A521188	FÜHRUNG PKR 74/82	GUIDE	GUIDE	1								
58	A521268	ROLLENLAGER 20X30X55	ROLLER BEARING	BOITE D'ESSIEU A ROULEAUX	2								
59	A521361	STARTERRELAIS 12V/100AMPER	STARTER RELAY	RELAIS D'ALLUMAGE	1								
60	A521375	SKT-MU.+SPERRZ.1/4"-20 UN 8.8	NUT	ECROU	2								
61	A521395	VERSTELLKONSOLE SITZ GENIETET	FIXED SEAT SUPP.	SUPPORT SIEGE FIXE	1								
62	A521461	ANBINDUNGSBLECH RECHTS	STIFFENING RIGHT	RENFORCEMENT DROITE	1								
63	A521462	ANBINDUNGSBLECH LINKS	STIFFENING LEFT	RENFORCEMENT GAUCHE	1								
64	A521475	WÄRMELEITBLECH UNTEN H-4 UND 2 ZYLINDER	PLATE	PLATEAU	1								
65	A521480	FLÜGELSCHRAUBE M8X20	WING SCREW	VIS A AILETTES	2								
66	A521727	DISTANZBUCHSE	SPACER	ENTRETOISE	2								
67	A52185840	VORDERRAD 13X6.0-6 KPL R9006	FRONT WHEEL 13X6.0-6	ROUE AVANT 13X6.0-6	2								
68	A523134	SFS-TAPT.M6X12 2021 A2K	SCREW	VIS	1								
69	A546220	SCHLAUCH 13"X6.5"-6 TR13	TUBE	TUYAU	2								
70	A582737	SHR DUO-TAP 5X10-C ST A2K	SCREW	VIS	2								

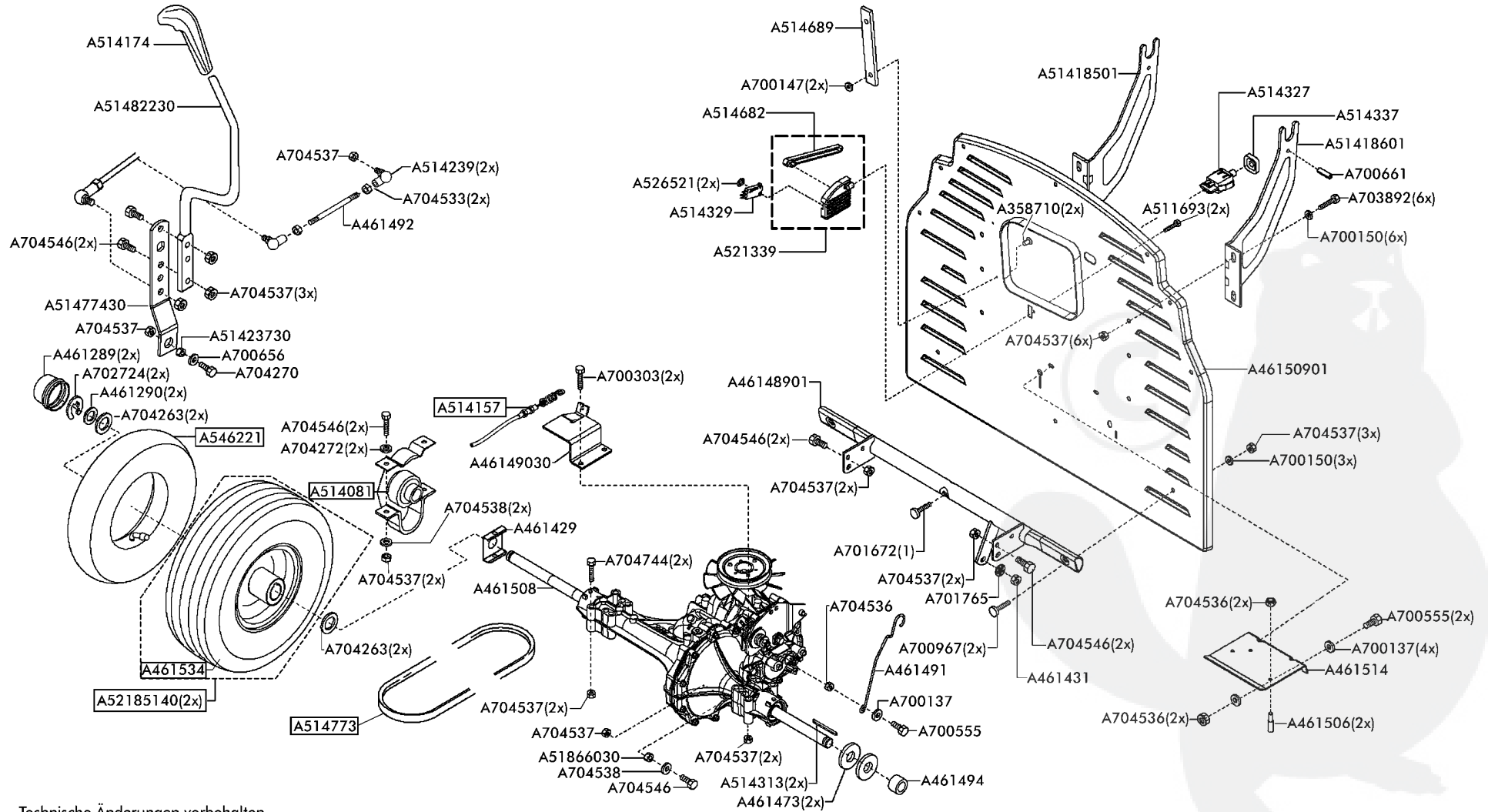

6/22		RASENTRAKTOREN		 RAHMENSATZ & LENKGETRIEBE CHASSIS & STEERING CHASSIS & BARRE DE DIRECTION		Crossover		74 / 13 Hydro - Art. 65054		3/3		 	
2007		LAWN TRACTORS				Crossover		Modell 2007					
Rev070601		Tracteurs de pelouse											
Bild Nr. REF.N° POS.N°	BEST.-NR. PART.-N° N° d. PIECE	BEZEICHNUNG		DESCRIPTION		DÉSIGNATION		Qty.					
71	A625877	SEGMENT "FE/ZN 12 F"		SEGMENT		SEGMENT		1					
72	A700051	SHR 8X 20 912- 8.8 VZ		SCREW		VIS		2					
73	A700137	SCHEIBE A 6,4 125-ST VZ		WASHER		RONDELLE		2					
74	A700148	SHB 6,4 9021-ST VZ		WASHER		RONDELLE		5					
75	A700150	SHB 8,4 9021-ST VZ		WASHER		RONDELLE		4					
76	A700151	SHB 10,5 9021-ST VZ		WASHER		RONDELLE		1					
77	A700200	SHB FÄCHER- J 6,4 6798 VZ		WASHER		RONDELLE		2					
78	A700203	NIPPEL AS 6X1 KEG 71412		NIPPLE AS 6X1 KEG 71412		RACCORD DE GRAISSAGE AS 6X1 KEG 71412		2					
79	A700545	SHR 8X 16 933- 8.8VZ		SCREW		VIS		4					
80	A700555	SHR 6X 16 933- 8.8VZ		SCREW		VIS		3					
81	A700719	SHB 21 433 VZ		WASHER		RONDELLE		1					
82	A701011	SHR 8X 50 933- 8.8VZ		SCREW		VIS		4					
83	A701070	SHR10X 40 933- 8.8VZ		SCREW		VIS		1					
84	A701083	SCHEIBE 8,4VZ7349"701083"		WASHER		RONDELLE		2					
85	A701166	SHB PA 20X28X0,5 988		WASHER		RONDELLE		2					
86	A701395	BLINDNIET 4,0X 8		RIVET		RIVET		4					
87	A701765	SHB FÄCHER- A 8,4 6798 VZ		WASHER		RONDELLE		4					
88	A701985	SCHRAUBE 8X 55 931- 8.8VZ		SCREW		VIS		2					
89	A702381	SHR 8X 30 7991- 8.8 VZ		SCREW		VIS		1					
90	A702574	SCHEIBE PA 14X20X1,0 988 VZ		WASHER		RONDELLE		1					
91	A702724	SHB SICH 15 6799 VZ		WASHER		RONDELLE		3					
92	A702812	SHR10X 55 931- 8.8A3C		SCREW		VIS		1					
93	A702893	SCHEIBE SICH 10 6799 DAC		WASHER		RONDELLE		1					
94	A703005	SHB 6,4 9021-ST A3S		WASHER		RONDELLE		1					
95	A703813	MU 6KT 10 985-10 A3B		NUT		ECROU		4					
96	A704138	SHR 6X 16 603- 4.6A3B		SCREW		VIS		4					
97	A704264	BOLZ A 5 H11X 14 EN22341- A3F		PIN		PIVOT		1					
98	A704368	SHR 6X 18 933- 8.8A3C		SCREW		VIS		2					
99	A704534	MU 10 934- 8 A3B		NUT		ECROU		4					
100	A704536	MUTTER 6KT 6 985- 8 A3B		NUT		ECROU		10					
101	A704537	MU 6KT 8 985- 8 A3B		NUT		ECROU		12					
102	A704540	SCHEIBE A 13 125-ST A3B		WASHER		RONDELLE		1					
103	A704546	SHR 8X 20 933- 8.8A3B		SCREW		VIS		2					

Crossover
74 / 13 Hydro
Art. 65054
2007
 3-8

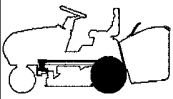

Technische Änderungen vorbehalten

8/22		RASENTRAKTOREN		 GETRIEBE TRANSMISSION TRANSMISSION	Crossover		1/2	 
2007		LAWN TRACTORS			74 / 13 Hydro - Art. 65054			
Rev070601		Tracteurs de pelouse			Modell 2007			
Bild Nr. REF.N° POS.N°	BEST.-NR. PART.-N° N° d. PIECE	BEZEICHNUNG	DESCRIPTION	DÉSIGNATION	Qty.			
1	A358710	NIET BLIND-4.8-ST-VZ 10 MM	RIVET	RIVET	2			
2	A461289	ABDECKKAPPE"TRAKTOR"	HUB COVER	COUVRE MOYEU	2			
3	A461290	SCHEIBE 42MM FÜR TRAKTOR	WASHER	RONDELLE	2			
4	A461429	KLEMMBLECH 51118	CLAMP PLATE	BORNE	1			
5	A461431	MUTTER 5/16" UNC B	NUT	ECROU	1			
6	A461473	ANLAUFSCHLEIBE 52119	WASHER	RONDELLE	2			
7	A46148901	DREHMOMENTABSTÜTZUNG GESCHW R9005	SUPPORT ASSY	SUPPORT CPL	1			
8	A46149030	WIDERLAGER BREMSE VERZ.	BEARING	COUSSINET	1			
9	A461491	BAYPASSHEBEL HYDRO GEAR 310-0510	LEVER	LEVIER	1			
10	A461492	VERSTELLELEMENT HYDRO GEAR	TIE ROD	TIRANT	1			
11	A461494	DISTANZHÜSLE LINKES RAD HY-GEAR 310-051	SPACER	DOUILLE	1			
12	A461506	BOLZEN	BOLT	BOULLON	2			
13	A461508	GETRIEBE-HYDRO GEAR HG 346-0510	HYDROSTATC GEARBOX HG 346-0510	HYDROSTATIQUE TRANSMISSION HG 346-051	1			
14	A46150901	RÜCKWAND 2 R9005	PLATE	PLAQUE	1			
15	A461514	RIEMENFÜHRUNG HINTEN	BELT GUIDE	GUIDE DE COURROIE	1			
16	A461534	MANTEL FÜR REIFEN 18X6,50-8 2PR	TIRE 18X6,50-8 2PR	PNEU 18X6,50-8 2PR	2			
17	A511693	SCHRAUBE PT-KB 5X10 WN1411 A3B	SCREW	VIS	2			
18	A514081	Y-STEHLAGER 3/4"	SUPPORT ASSY	SUPPORT CPL	1			
19	A514157	SCHALT-BOWDENZUG-BREMSE	BOWDEN CABLE	FIL	1			
20	A514174	SCHALTGRIF	KNOB	POIGNEE	1			
21	A51418501	LAGERARM RE.LACK R9005	SUPPORT RIGHT	SUPPORT DROITE	1			
22	A51418601	LAGERARM LI LACK R9005	SUPPORT LEFT	SUPPORT GAUCHE	1			
23	A51423730	DISTANZBUCHSE VERZ.	SPACER	ENTRETOISE	1			
24	A514239	WINKELGELENK C13SXN68/02R	JOINT	JOINT	2			
25	A514313	PASSFEDER 3/16"X3/16"X2 1/4	FIT-IN KEY	GOUPILLE	2			
26	A514327	DRUCKSCHALTER	PRESS SWITCH	INTERRUPTEUR À PRESSION	1			
27	A514329	MIKROSCHALTER FÜLLSTANDANZEIGE	SWITCH	INTERRUPTEUR	1			
28	A514337	ABDECKTÜLLE FÜR DRUCKSCHALTER	COVER	COUVERCLE PROTECTION	1			
29	A514682	SCHALTHEBEL LANG	LEVER	LEVIER	1			
30	A514689	SCHUTZLAPPEN	GUARD	GUARD	1			
31	A514773	RIEMEN A 110	BELT A 110	COURROIE	1			
32	A51477430	FEDERBLECH SCHALTUNG VERZ	SPRING PLATE	MACARON RESSORT	1			
33	A51482230	SCHALTHEBEL VERZ	LEVER	LEVIER	1			
34	A51866030	DISTANZHÜLSE-TOTMANN VERZ	SPACER	DOUILLE	1			
35	A521339	FÜLLSTANDSUMMERGEHÄUSE UND HEBEL	PROTECTION COVER & LEVER CPL	COUVERCLE PROTECTION & LEVIER CPL	1			
36	A52185140	HINTERRAD 18X6.5-8 SCHMAL KPL R9006	REAR WHEEL 18X6.5-8	ROUE ARRIERE 18X6.5-8	2			
37	A526521	SCHNELLBEFESTIGER 3SXN26	CROWN FASTENER	FIXATEUR A COURONNE	2			
38	A546221	SCHLAUCH 18"X6.5"-8 TR13	TUBE	TUYAU	2			

9/22		RASENTRAKTOREN		 GETRIEBE TRANSMISSION TRANSMISSION	Crossover		74 / 13 Hydro - Art. 65054 Modell 2007	2/2  
2007		LAWN TRACTORS						
Rev070601		Tracteurs de pelouse						
Bild Nr. REF.N° POS.N°	BEST.-NR. PART-N° N° d. PIECE	BEZEICHNUNG	DESCRIPTION	DÉSIGNATION	Qty.			
39	A700137	SCHEIBE A 6,4 125-ST VZ	WASHER	RONDELLE	5			
40	A700147	SCHEIBE 5,3 9021-ST VZ	WASHER	RONDELLE	2			
41	A700150	SCHEIBE 8,4 9021-ST VZ	WASHER	RONDELLE	9			
42	A700303	SCHRAUBE 8X 70 931- 8.8VZ	SCREW	VIS	2			
43	A700555	SCHRAUBE 6X 16 933- 8.8VZ	SCREW	VIS	3			
44	A700656	FED TEL 28 X10,2X1,25 2093	DISK SPRING	DISQUE	1			
45	A700661	HUEL SPAN 6 X 20 1481	BUSHING	DOUILLE	1			
46	A700967	SHR 8X 35 603- 4.6VZ	SCREW	VIS	2			
47	A701672	SCHRAUBE	SCREW	VIS	1			
48	A701765	SHB FÄCHER- A 8,4 6798 VZ	WASHER	RONDELLE	1			
49	A702724	SCHEIBE SICH 15 6799 VZ	WASHER	RONDELLE	2			
50	A703892	SCHRAUBE 8X 45 933- 8.8A3B	SCREW	VIS	6			
51	A704263	SHB S 19X26X1,5 988A3C	WASHER	RONDELLE	4			
52	A704270	SHR 8X25 EN ISO7380-10.9A3C	SCREW	VIS	1			
53	A704272	SCHEIBE PA 8X14X1,0 988	WASHER	RONDELLE	2			
54	A704533	MUTTER 8 934- 8 A3B	NUT	ECROU	2			
55	A704536	MUTTER 6KT 6 985- 8 A3B	NUT	ECROU	5			
56	A704537	MUTTER 6KT 8 985- 8 A3B	NUT	ECROU	25			
57	A704538	SCHEIBE A 8,4 125-ST A3B	WASHER	RONDELLE	3			
58	A704546	SCHRAUBE 8X 20 933- 8.8A3B	SCREW	VIS	9			
59	A704744	SCHRAUBE 8X 65 931- 8.8A3B	SCREW	VIS	2			



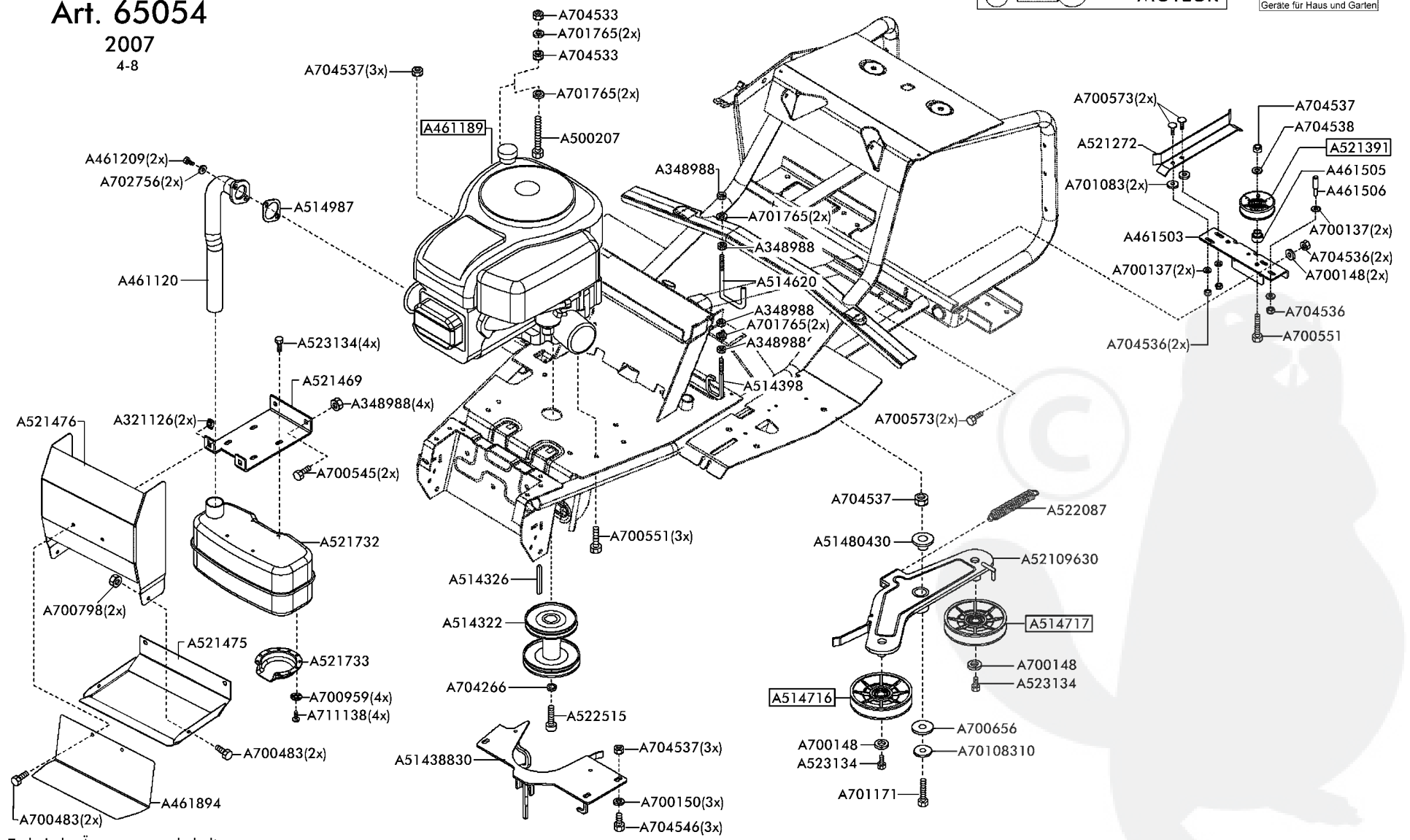
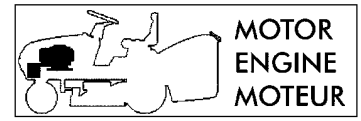

Crossover
74 / 13 Hydro
Art. 65054
 2007
 4-8



Technische Änderungen vorbehalten

11/22		RASENTRAKTOREN		Crossover							
2007		LAWN TRACTORS		74 / 13 Hydro - Art. 65054							
Rev070601		Tracteurs de pelouse		Modell 2007							
Bild Nr. REF.N° POS.N°		BEST.-NR. PART.-N° N° d. PIECE		BEZEICHNUNG		DESCRIPTION		DÉSIGNATION		Qty.	
						MOTOR ENGINE MOTEUR					
											
						1/2					
											
1	A321126	MUTTER KASTEN- M 6-ST GALVZ+PASSI	SQUARE NUT	ECROU	2						
2	A348988	MUTTER SICHT- BIW M 8 A3C- 8 MITTELGESICHT	NUT	ECROU	8						
3	A461120	KRÜMMER B&S AUSPUFF GESCHW	EXHAUST CONNECTING TUBE	TUBE DE CONNEXION	1						
4	A461189	MOTOR B&S 13HP IC OHV AVS	ENGINE 13HP IC OHV AVS	MOTEUR 13HP IC OHV AVS	1						
5	A461209	SCHRAUBE ISKT UNC 5/16"X 3/4"A3B	SCREW	VIS	2						
6	A461503	BEFESTIGUNGSBLECH RIEMENFÜHRU HD 74/8	PLATE	PLAQUE	1						
7	A461505	ZENTRIERHÜLSE FÜR UMLENKROLLE	BUSH	DOUILLE	1						
8	A461506	BOLZEN	BOLT	BOULLON	1						
9	A461894	ABWEISBLECH	PLATE	PLATEAU	1						
10	A500207	SHR 8X 50 VERBUS RIPP A3R 8.8	SCREW	VIS	1						
11	A514322	ANTRIEBSSEGMENT 82/HYDRO	SEGMENT	SEGMENT	1						
12	A514326	PASSFEDER 1/4"X1/4"X1 3/4	FIT IN KEY	CLAVETTE	1						
13	A51438830	RIEMENFÜHRUNG GESCHW 115 VERZ	BELT GUIDE	GUIDE	1						
14	A514398	ÖSE-RIEMENFÜHRUNG MITTE	BELT GUIDE	GUIDAGE	1						
15	A514620	HALTEBÜGEL	SUPPORT	SUPPORT	1						
16	A514716	SPANNROLLE INNEN +LAGER	TENSIONER INSIDE ASSY	ROUE SERRAGE	1						
17	A514717	SPANNROLLE AUSSEN+LAGER	TENSION ROLL ASSY. OUTSIDE	ROUE SERRAGE À L'EXTÉRIEUR	1						
18	A51480430	DISTANZBUCHSE WIPE VERZ	SPACER	ENTRETOISE	1						
19	A514987	FLANSCHDICHTUNG B&S 27229	FLANGE SEAL	JOINT	1						
20	A52109630	SPANNROLLENWIPPE D16 GESCHW VERZ	LEVER D16	LEVIER D16	1						
21	A521272	RIEMENFÜHRUNGSBLECH RECHTS	BELT GUIDE RIGHT	GUIDAGE DROITE	1						
22	A521391	UMLENKROLLE ALU+LAGER	PULLEY ASSY	POULIE GUIDAGE CPL	1						
23	A521469	AUSPUFFHALTEBLECH	SUPPORT	SUPPORT	1						
24	A521475	WÄRMELEITBLECH UNTEN H-4 UND 2 ZYLINDER	LOWER GUARD	GUARD EN BAS	1						
25	A521476	LUFTLEITBLECH 2-ZYLINDER	AIR GUIDE	DÉFLECTEUR	1						
26	A521732	AUSPUFF B&S P 498984	MUFFLER	SILENCEUX	1						
27	A521733	DEFLECTOR B&S P 222573	DEFLECTOR	DEFLECTEUR	1						
28	A522087	ZUGFEDER-BBC	SPRING	RESSORT	1						
29	A522515	SCHR ISKT UNF 7/16"X1 1/4 A3S 12.9	SCREW	VIS	1						
30	A523134	SFS-TAPT.M6X12 2021 A2K	SCREW	VIS	6						
31	A700137	SCHEIBE A 6,4 125-ST VZ	WASHER	RONDELLE	4						
32	A700148	SCHEIBE 6,4 9021-ST VZ	WASHER	RONDELLE	4						
33	A700150	SCHEIBE 8,4 9021-ST VZ	WASHER	RONDELLE	3						
34	A700483	SCHRAUBE 6X 12 933- 8.8VZ	SCREW	VIS	4						
35	A700545	SCHRAUBE 8X 16 933- 8.8VZ	SCREW 8X 16 933- 8.8VZ	VIS 8X 16 933- 8.8VZ	2						
36	A700551	SCHRAUBE 8X 35 933- 8.8A3C	SCREW	VIS	4						
37	A700573	SCHRAUBE 6X 20 603- 4.6VZ	SCREW	VIS	4						

12/22	RASENTRAKTOREN	 MOTOR ENGINE MOTEUR	Crossover		 2/2  Gloria für Haus und Garten
2007	LAWN TRACTORS		74 / 13 Hydro - Art. 65054		
Rev070601	Tracteurs de pelouse		Modell 2007		
Bild Nr. REF.N° POS.N°	BEST.-NR. PART-N° N° d. PIECE	BEZEICHNUNG	DESCRIPTION	DÉSIGNATION	Qty.
38	A700656	FED TEL 28 X10,2X1,25 2093	DISK SPRING	DISQUE	1
39	A700798	MU 6KT 6 980-V- 8	NUT	ECROU	2
40	A700959	SHB FÄCHER- A 4,3 6798 VZ	WASHER	RONDELLE	4
41	A701083	SCHEIBE 8,4VZ7349"701083"	WASHER	RONDELLE	2
42	A70108310	SCHEIBE 8,4VZ7349"701083"	WASHER	RONDELLE	1
43	A701171	SCHRAUBE 8X 30 933- 8.8VZ	SCREW	VIS	1
44	A701765	SCHEIBE FÄCHER- A 8,4 6798 VZ	WASHER FÄCHER- A 8,4 6798 VZ	RONDELLE FÄCHER- A 8,4 6798 VZ	8
45	A702756	SCHEIBE SICH SCHNORR S 8 MECHANVZ	WASHER	RONDELLE	2
46	A704266	SHB FÄCHER- J 13,0 6798 A3C	WASHER	RONDELLE	1
47	A704533	MUTTER 8 934- 8 A3B	NUT	ECROU	2
48	A704536	MUTTER 6KT 6 985- 8 A3B	NUT	ECROU	5
49	A704537	MUTTER 6KT 8 985- 8 A3B	NUT	ECROU	8
50	A704538	SCHEIBE A 8,4 125-ST A3B	WASHER	RONDELLE	1
51	A704546	SCHRAUBE 8X 20 933- 8.8A3B	SCREW	VIS	3
52	A711138	SCHRAUBE B&S	SCREW B&S	VIS B&S	4

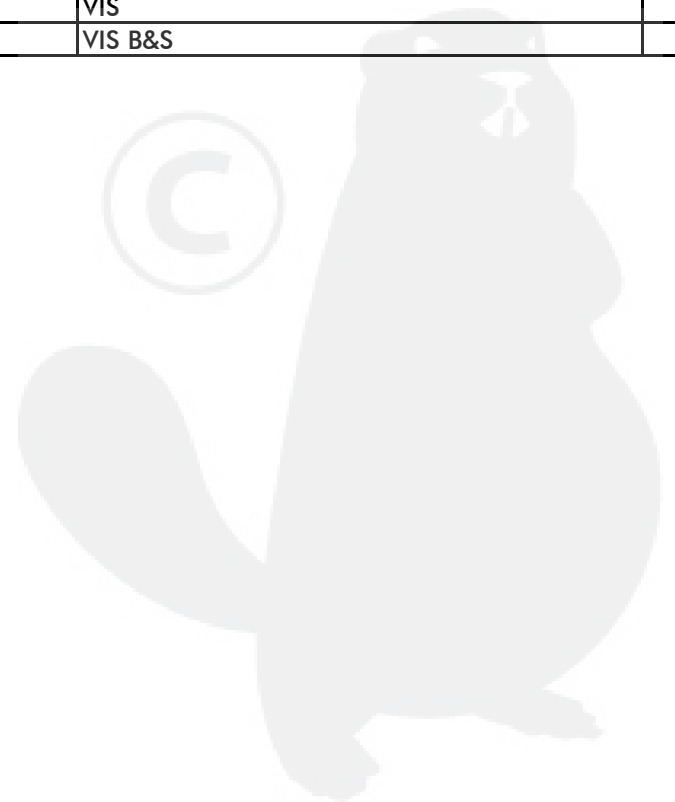

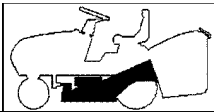

Crossover
74 / 13 Hydro
Art. 65054
 2007
 5-8

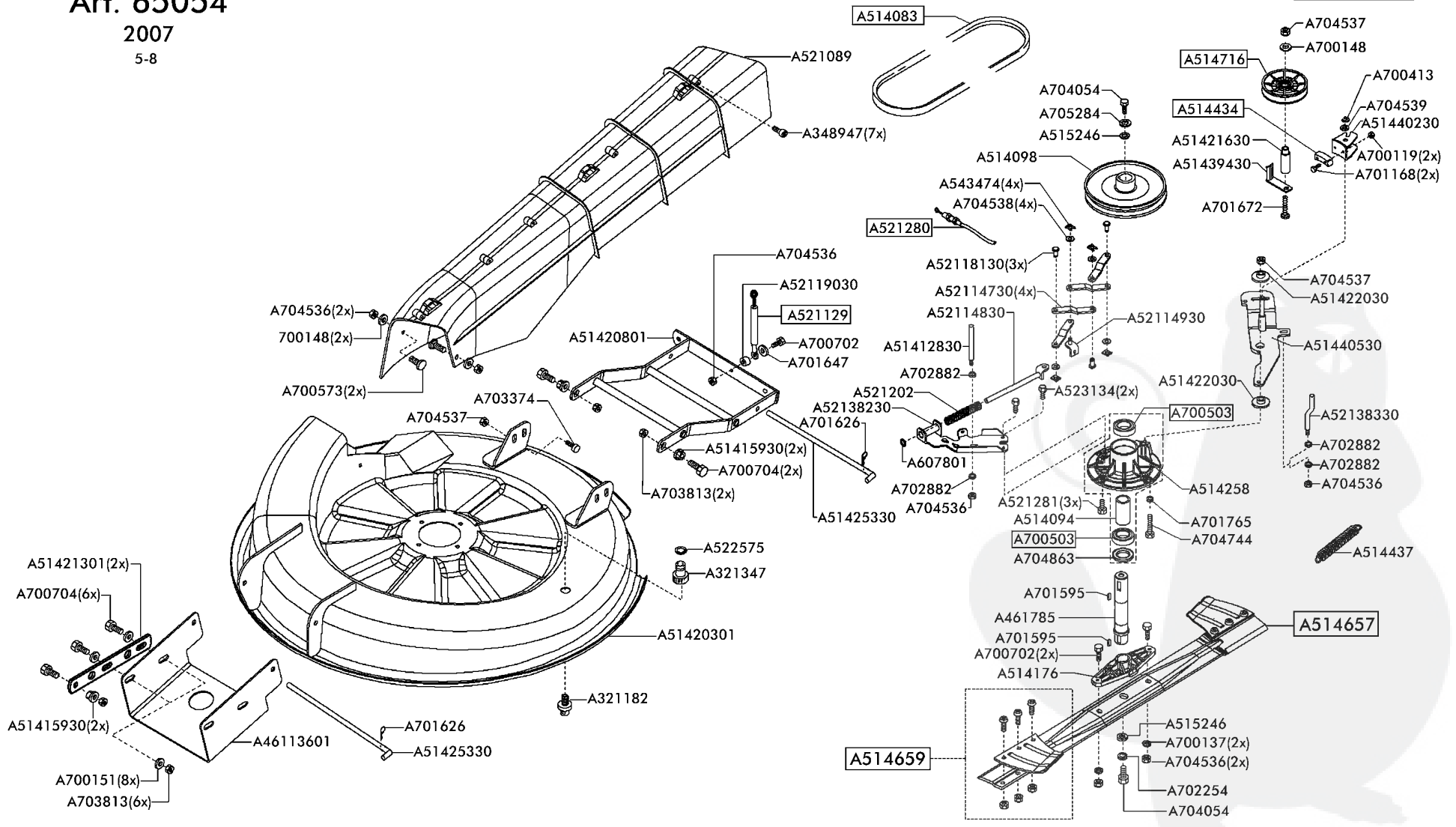

14/22	RASENTRAKTOREN		SCHNEIDWERK	Crossover	
2007	LAWN TRACTORS		CUTTING PLATE	74 / 13 Hydro - Art. 65054	
Rev070601	Tracteurs de pelouse		PLATEAU DE COUPE	Modell 2007	
Bild Nr. REF.N° POS.N°	BEST.-NR. PART.-N° N° d. PIECE	BEZEICHNUNG	DESCRIPTION	DÉSIGNATION	Qty.
1	A321182	SPÜLDÜSE R1/2"	WATER HOSE CONNECTION	RACCORD TUYAU D'EAU	1
2	A321347	ANSCHLUSS R1/2"	TUBE ADAPTER	ADAPTER TUYAU	1
3	A348947	SCHRAUBE PT-KB 60X20 1442	SCREW	ECROU	7
4	A46113601	MÄHDECKAUFHÄNGUNG VORNE R9005	CUTTING PLATE SUPPORT FRONT	PLATEAU SUSPENSION L'AVANT	1
5	A461785	MESSERWELLE TRAKTOR VERZ	BLADE SHAFT	ABRE	1
6	A514083	KEILRIEMEN MÄHWERK	BELT	COURROIRE	1
7	A514094	DISTANZBUCHSE-1	SPACER	ENTRETOISE	1
8	A514098	KEILRIEMENSCHLEIBE MÄHANTRIEB	PULLEY	POULIE	1
9	A51412830	FÜHRUNGSSTANGE VERZ.	ROD	BARRE	1
10	A51415930	DISTANZSCHEIBE VERZ	SPACER	ENTRETOISE	4
11	A514176	MESSERHALTER	BLADE FLANGE	BRIDE	1
12	A51420301	SCHNEIDGEHÄUSE 74 GESCHW R9005	CUTTING PLATE 74	PLATEAU 74	1
13	A51420801	HÖHENVERSTELLUNG HINTEN GESCHW R9005	REAR HIGH ADJUSTMENT FRAME		1
14	A51421301	SCHENKEL-VORNE HÖHENVERSTELLUNG R9005	SUPPORT	SUPPORT	2
15	A51421630	ZENTRIERHÜLSE VERZ.	BUSH	DOUILLE	1
16	A51422030	DISTANZSCHEIBE VERZ	SPACER	ENTRETOISE	2
17	A51425330	ABSTECKSTANGE VERZ.	ROD	BARRE	2
18	A514258	LAGERBOCK KPL.	BLADE FLANGE ASSY. CPL	ENS. BRIDE POUR LAME CPL	1
19	A51439430	RIEMENFÜHRUNG VERZ	BELT GUIDE	GUIDE	1
20	A51440230	BREMSBACKEN VERZ	BRAKE SHOE	SEGMENT DE FREIN	1
21	A51440530	SPANN-BREMSHEBEL GESCHW VERZ	BOLT LEVER	LEVIER DE SERRAGE	1
22	A514434	BREMSKLOTZ	BRAKE PAD	PLACETTE DE FREIN À DISQUE	1
23	A514437	BREMSFEDER	BRAKE SPRING	FRENAGE À RESSORT	1
24	A514657	MESSER KOMPLETT 74 CM	BLADE 74 CM	LAME 74 CM	1
25	A514659	MESSERSCHAUFEL 8.5 KP.ET	BLADE WING SET	LAME FLANK	1
26	A514716	SPANNROLLE INNEN +LAGER	TENSIONER INSIDE ASSY	ROUE SERRAGE	1
27	A515246	SCHEIBE 30/10,5 X 5	WASHER	RONDELLE	2
28	A521089	AUSWURFKANAL VERSCHRAUBT R9005	CONVEYOR ASSY.	ENS. CONVOYEUR	1
29	A521129	BOWDENZUG HÖHENVSTELLUNG 82	BOWDEN CABLE	CABLE BOWDEN	1
30	A52114730	LASCHE PKR 74/82 VERZ	PLATE	LANGUETTE	4
31	A52114830	SCHUBSTANGE GESCHW PKR VERZ	PUSH ROD	BARRE POUSSE	1
32	A52114930	WINKEL PKR 74/82 VERZ	BRACKET	JARRET	1
33	A52118130	BOLZEN PKR 74/82 VERZ.	PIN	PIVOT	3
34	A52119030	PENDELHÜLSE HÖHENVERSTELLUNG VERZ	BUSH	DOUILLE	1
35	A521202	DRUCKFEDER	PRESSURE SPRING	RESSORT DE PRESSION	1
36	A521280	BOWDENZUG-MESSERBREMSE	BOWDEN CABLE /BRAKE	CABLE BOWDEN /FREIN	1
37	A521281	SCHRAUBE-TAPT 8X25 SPERRZ.A3S	SCREW	VIS	3

15/22	RASENTRAKTOREN		SCHNEIDWERK CUTTING PLATE PLATEAU DE COUPE	Crossover		2/2  
2007	LAWN TRACTORS			74 / 13 Hydro - Art. 65054		
Rev070601	Tracteurs de pelouse			Modell 2007		
Bild Nr. REF.N° POS.N°	BEST.-NR. PART.-N° N° d. PIECE	BEZEICHNUNG	DESCRIPTION	DÉSIGNATION	Qty.	
38	A52138230	HALTEBLECH GESCHW VERZ	SUPPORT	SUPPORT	1	
39	A52138330	FÜHRUNGSSTANGE GEKRÖPFT VERZ	ROD	BARRE	1	
40	A522575	O-RING D10,78X2,62 NBR	O-RING	O-RING	1	
41	A523134	SFS-TAPT.M6X12 2021 A2K	SCREW	VIS	2	
42	A543474	SL SICHERUNG 8SXNO8	SNAP RING 8SXNO8	CIRCLIPS 8SXNO8	4	
43	A607801	SCHNELLBEFESTIGER10SXN26	Quick-fixing-device	Starlock	1	
44	A700119	MUTTER 6KT 5 985- 8 VZ	NUT	ECROU	2	
45	A700137	SCHEIBE A 6,4 125-ST VZ	WASHER	RONDELLE	2	
46	A700148	SCHEIBE 6,4 9021-ST VZ	WASHER	RONDELLE	3	
47	A700151	SCHEIBE 10,5 9021-ST VZ	WASHER	RONDELLE	8	
48	A700413	Sicherungsring DIN 471 10x1	CIRCLIP DIN 471 10x1	JOINT SPI	1	
49	A700503	KUGELLAGER 6205 2RS 625	BALL BEARING	ROULEMENT À BILLES	2	
50	A700573	SCHRAUBE 6X 20 603- 4.6VZ	SCREW	VIS	2	
51	A700702	SCHRAUBE 6X 25 933- 8.8VZ	SCREW	VIS	3	
52	A700704	SCHRAUBE10X 30 933- 8.8VZ	SCREW	VIS	8	
53	A701168	SHR ZYL 5 X20 84 VZ	SCREW	VIS	2	
54	A701595	PASSFEDER 8X7X20 6885	FIT-IN KEY	GOUPILLE	2	
55	A701626	FEDERSTECKER - 2,5 11024 VZ	COTTER PIN	GOUPILLE	2	
56	A701647	SHB R 6,6 VZ 440	WASHER	RONDELLE	1	
57	A701672	Schraube	SCREW	VIS	1	
58	A701765	SCHEIBE FÄCHER- A 8,4 6798 VZ	WASHER FÄCHER- A 8,4 6798 VZ	RONDELLE FÄCHER- A 8,4 6798 VZ	1	
59	A702254	SCHEIBE FÄCHER- A 10,5 6798 VZ	WASHER	RONDELLE	1	
60	A702882	SHB A 6,4 125-ST A3S	WASHER	RONDELLE	4	
61	A703374	SHR 8X 16 912- 8.8A3R	SCREW	VIS	1	
62	A703813	MUTTER 6KT 10 985-10 A3B	NUT	ECROU	8	
63	A704054	SCHRAUBE10X1,0 X 35 961- 8.8	SCREW	VIS	2	
64	A704536	MUTTER 6KT 6 985- 8 A3B	NUT	ECROU	7	
65	A704537	MUTTER 6KT 8 985- 8 A3B	NUT	ECROU	3	
66	A704538	SCHEIBE A 8,4 125-ST A3B	WASHER	RONDELLE	4	
67	A704539	SHB A 10,5 125-ST A3B	WASHER	RONDELLE	1	
68	A704744	SCHRAUBE 8X 65 931- 8.8A3B	SCREW	VIS	1	
69	A704863	RWDR AS 30X 52X 5 3760-NB	WASHER	RONDELLE	1	
70	A705284	TELLERFEDER 28 X10,2X1,5 2093	DISK SPRING	RESSORT D'ASSIETTE	1	

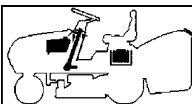

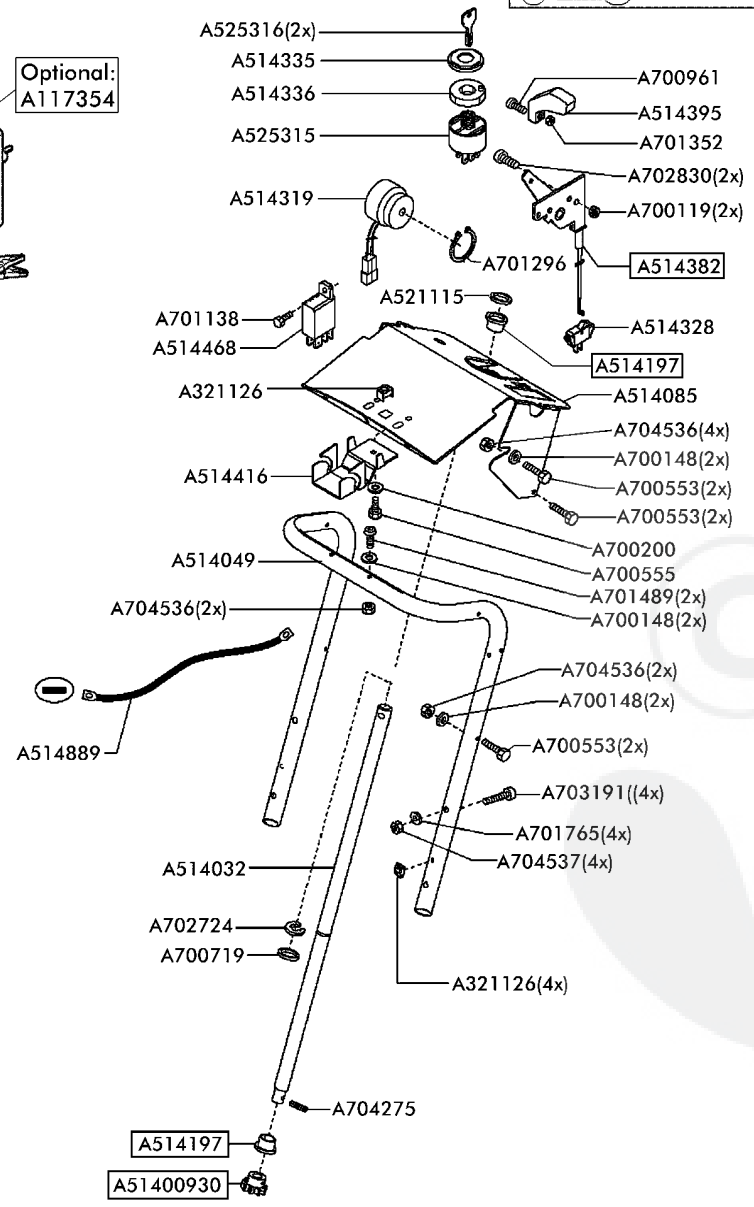
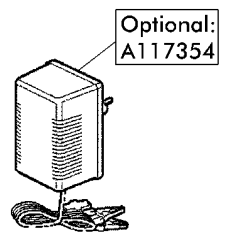
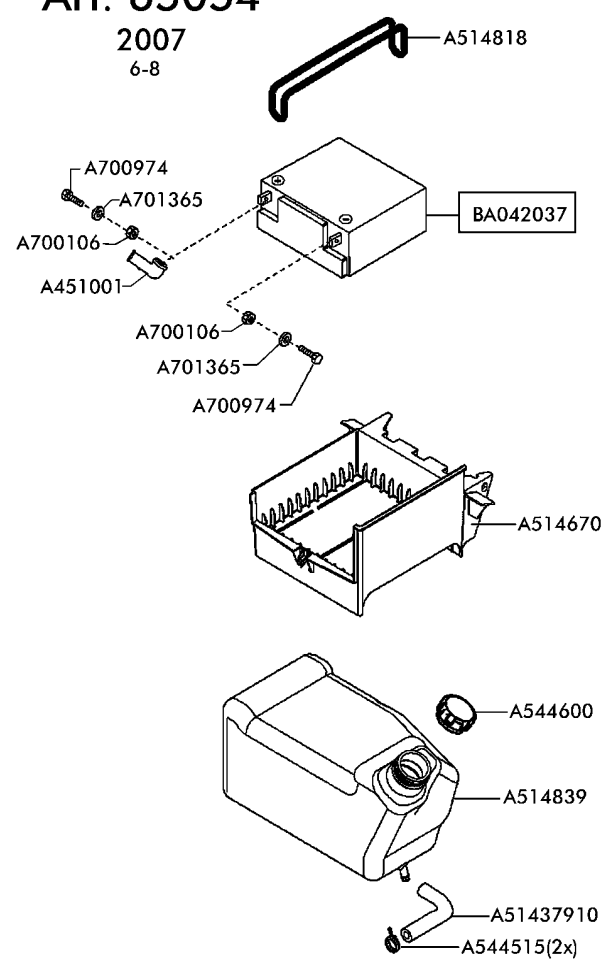
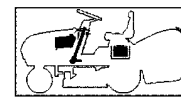

Crossover
74 / 13 Hydro
Art. 65054
2007
 6-8



Technische Änderungen vorbehalten

17/22		RASENTRAKTOREN		Crossover	
2007		LAWN TRACTORS		74 / 13 Hydro - Art. 65054	
Rev070601		Tracteurs de pelouse		Modell 2007	
					
		TANK, BATTERIE & KOMPONENTEN TANK, BATTERY & COMPONENTS TANK, BATTERIE & COMPOSANTS			
				1/2  	
Bild Nr. REF.N° POS.N°	BEST.-NR. PART-N° N° d. PIECE	BEZEICHNUNG	DESCRIPTION	DÉSIGNATION	Qty.
1	A117354	LADEGERÄT Crossover 12 V (optional)	CHARGER Crossover 12 V (optional)	CHARGEUR Crossover 12 V (optional)	1
2	A321126	MUTTER KASTEN- M 6-ST GALVZ+PASSI	NUT	ECROU	4
3	A451001	BATTERIEPOLABDECKUNG FÜR BATTERIE CSB	POL COVER	COUVERCLE DE PROTECTION	1
4	A51400930	LENKUNGSRITZEL VERZ.	STEERING WHEEL	PIGNON	1
5	A514032	LENKSÄULE VERZ	STEERING COLUMN	TUBE DE DIRECTION	1
6	A514049	STÜTZHOLM	SUPPORT	SUPPORT	1
7	A514085	STÜTZBLECH	SUPPORT	SUPPORT	1
8	A514197	EP-BUNDBUCHSE	BUSH	DOILLE	2
9	A514319	FÜLLSTANDSUMMER	BUZZER (GRASS BAG FULL)	BUZZER	1
10	A514328	KIPPSCHALTER LICHT	ROCKER SWITCH I/O	INERRUPTEUR À BASCULE	1
11	A514335	BEFESTIGUNGS MUTTER ZÜNDSCHLOSS	LOCK NUT	EMBOU	1
12	A514336	VERDREHSICHERUNG ZÜNDSCHLOSS	SAFETY NUT	EMBOU	1
13	A51437910	BENZINSCHLAUCH ZUSCHNITT	CONNECTING TUBE	TUBE DE CONNEXION	1
14	A514382	GASFERNBEDIENUNG	ACCELERATOR	ACCELERATEUR	1
15	A514395	BEDIENHEBEL	LEVER	LEVIER	1
16	A514416	EINRASTBLECH	ENGAGE PLATE	PANNEAU ENCLIQUETER	1
17	A514468	MIKRORELAIS 12V 10/20A	MICROSWITCH	MICROINTERRUPTEUR	1
18	A514670	BATTERIEKASTEN	BATTERY INSERT	BATTERIE CAISSE	1
19	A514818	BEFESTIGUNGSGUMMI	RUBBER BAND	ÉLASTIQUE	1
20	A514839	BENZINTANK	TANK	RESERVOIR	1
21	A514889	ZUSATZ MASSEKABEL	GROUND CABLE	CABLE	1
22	A521115	SCHNELLBEFESTIGER20SXN26	CROWN FASTENER	FIXATEUR A COURONNE	1
23	A525315	ZÜNDANLASSCHALTER RIDER	IGNITION SWITCH	INTERRUPTEUR DEMARR. /1	1
24	A525316	ZÜNDSCHLÜSSEL	STARTING KEY	CLEF A DEMARRAGE	2
25	A544515	SCHLAUCHKLEMME 14,5	TUBE CLAMP	BORNE	2
26	A544600	TANKDECKEL KPL	TANK CAP	BOUCHON DE RÉSERVOIR	1
27	A700106	MUTTER 5 934- 8 VZ	NUT	ECROU	2
28	A700119	MUTTER 6KT 5 985- 8 VZ	NUT	ECROU	2
29	A700148	SCHEIBE 6,4 9021-ST VZ	WASHER	RONDELLE	6
30	A700200	SCHEIBE FÄCHER- J 6,4 6798 VZ	WASHER	RONDELLE	1
31	A700553	SCHRAUBE 6X 40 933- 8.8VZ	SCREW	VIS	6
32	A700555	SCHRAUBE 6X 16 933- 8.8VZ	SCREW	VIS	1
33	A700719	SCHEIBE 21 433 VZ	WASHER	RONDELLE	1
34	A700961	SCHRAUBE 4X 8 7985- 4.8-H VZ	SCREW	VIS	1
35	A700974	SCHRAUBE 5X 16 933- 8.8VZ	SCREW	VIS	2
36	A701138	SCHRAUBE ST4,2X13 -C-H7981 VZ	SCREW	VIS	1
37	A701296	SICHERUNGSRING 25X1,2 471	CIRCLIP	CIRCLIPS	1
38	A701352	MUTTER 6KT 4 985- 8 VZ	NUT	ECROU	1

18/22	RASENTRAKTOREN		Crossover		2/2  
2007	LAWN TRACTORS		TANK, BATTERIE & KOMPONENTEN	74 / 13 Hydro - Art. 65054	
Rev070601	Tracteurs de pelouse		TANK, BATTERY & COMPONENTS	Modell 2007	
Bild Nr. REF.N° POS.N°	BEST.-NR. PART-N°. N° d. PIECE	BEZEICHNUNG	DESCRIPTION	DÉSIGNATION	Qty.
39	A701365	SCHEIBE FÄCHER- A 5,3 6798 VZ	WASHER	RONDELLE	2
40	A701489	SCHRAUBE 6X 35 933- 8.8VZ	SCREW	VIS	2
41	A701765	SCHEIBE FÄCHER- A 8,4 6798 VZ	WASHER FÄCHER- A 8,4 6798 VZ	RONDELLE FÄCHER- A 8,4 6798 VZ	4
42	A702724	SCHEIBE SICH 15 6799 VZ	WASHER	RONDELLE	1
43	A702830	SCHRAUBE 5X 12 7985- 4.8-H A3R	SCREW	VIS	2
44	A703191	SCHRAUBE 8X 40 7991- 8.8A3C	SCREW	VIS	4
45	A704275	SPANNSTIFT 6X24 7344	PIN	GOUPILLE	1
46	A704536	MUTTER 6KT 6 985- 8 A3B	NUT	ECROU	8
47	A704537	MUTTER 6KT 8 985- 8 A3B	NUT	ECROU	4
48	BA042037	BATTERIE 12V-17Ah	BATTERY 12 V-17Ah	BATTERIE 12V-17Ah	1





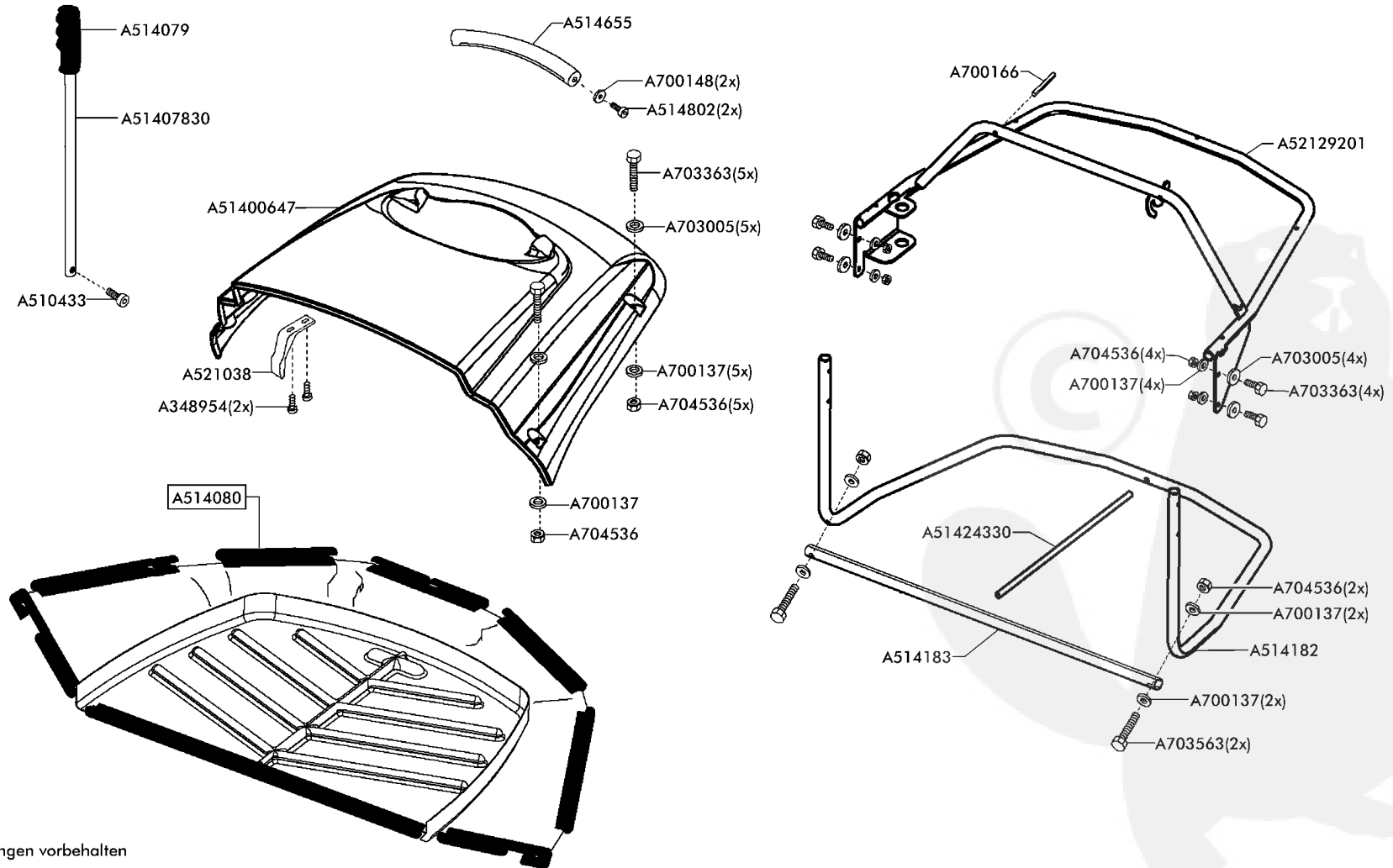
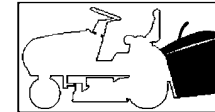

Crossover
74 / 13 Hydro
Art. 65054
 2007
 7-8

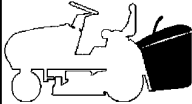

Technische Änderungen vorbehalten

20/22	RASENTRAKTOREN		GRASFANGSACK KPL.	Crossover		 
2007	LAWN TRACTORS		GRASS CATCHER ASSY.	74 / 13 Hydro - Art. 65054		
Rev070601	Tracteurs de pelouse		BAC COMPOSANTS	Modell 2007		
Bild Nr. REF.N° POS.N°	BEST.-NR. PART-N° N° d. PIECE	BEZEICHNUNG	DESCRIPTION	DÉSIGNATION	Qty.	
1	A348954	SCHRAUBE.PT-KB 60X25 1411 VZ	SCREW	VIS	2	
2	A510433	SCHR SFS-TAPT.6X12 2016	SCREW	VIS	1	
3	A51400647	BOXDECKEL R6001	GRASS-CATCHER COVER GREEN	COUVRE-BAC VERT	1	
4	A51407830	HANDHEBEL BOX VERZ	ROD	TIGE	1	
5	A514079	GRIFF FÜR HANDHEBEL	HANDLE	POINGEE	1	
6	A514080	GEWEBESACK KOMPLETT	GRASSCATCHER	SAC	1	
7	A514182	BOXROHR UNTEN 74/82	LOWER STIFFENING	RENFORCEMENT SUPER.	1	
8	A514183	QUERSTREBE BOX	ROD	TIGE	1	
9	A51424330	LÄNGSSTREBE VERZ	ROD	TIGE	1	
10	A514655	BOXGRIFF TRAKTOR	BOX HANDLE	POIGNEE ANTERIEURE	1	
11	A514802	PT-K 60X20 TORX 1452 VZ	SCREW	VIS	2	
12	A521038	KONTAKTWINKEL	BRACKET	EQUERRE-SUPPORT	1	
13	A52129201	BOXROHR GESCHW 74/82 R9005	UPPER FRAME	CHASSIS SUPERIEUR	1	
14	A700137	SCHEIBE A 6,4 125-ST VZ	WASHER	RONDELLE	14	
15	A700148	SCHEIBE 6,4 9021-ST VZ	WASHER	RONDELLE	2	
16	A700166	HUEL SPAN 6 X 40 1481	SPACER	ENTRETOISE	1	
17	A703005	SCHEIBE 6,4 9021-ST A3S	WASHER	RONDELLE	9	
18	A703363	SHR 6X 35 933- 8.8A3S	SCREW	VIS	9	
19	A703563	SCHRAUBE 6X 45 933- 8.8A3C	SCREW	VIS	2	
20	A704536	MUTTER 6KT 6 985- 8 A3B	NUT	ECROU	12	

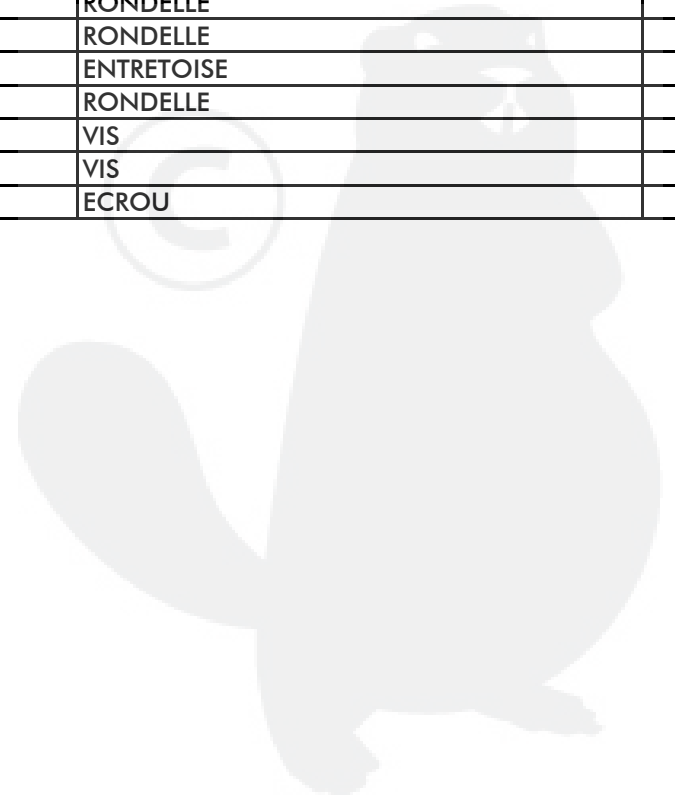

Crossover
74 / 13 Hydro
Art 65054

2007
8-8

ELEKTRIK
ELECTRIC
ELECTRIQUES

BRILL
GLORIA
Geräte für Haus und Garten

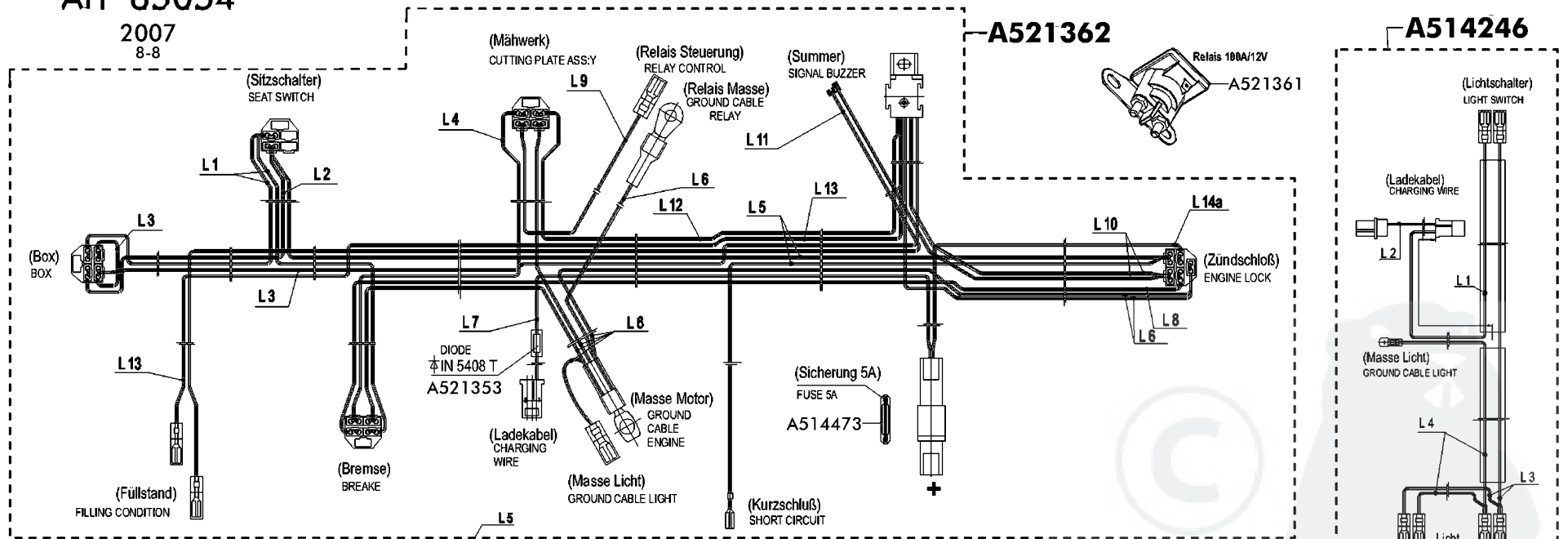

- L1 = rosa pink
- L2 = grau grey
- L3 = weiß white
- L4 = braun brown
- L5 = grün green
- L6 = schwarz black
- L7 = rot red
- L8 = violett violet
- L9 = orange orange
- L10 = gelb yellow
- L11 = blau blue
- L12 = rot/weiß red/white
- L13 = weiß/blau white/blue
- L14 a = rot red
- (L14 b) = rot red
- (L15 a) = rot red
- (L15 b) = rot red
- (L16) = blau blue

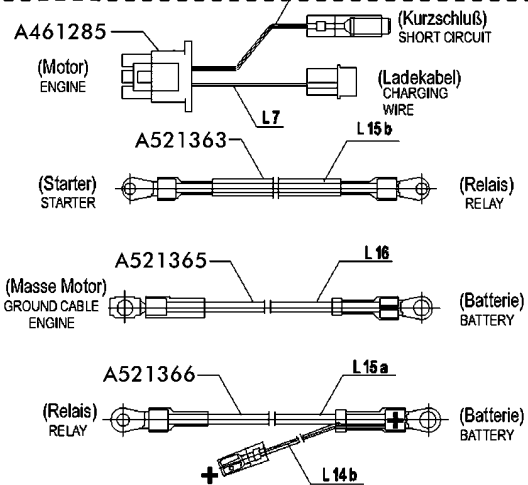

Schaltplan Traktor E-Start
CONNECTION DIAGRAM E-STARTER

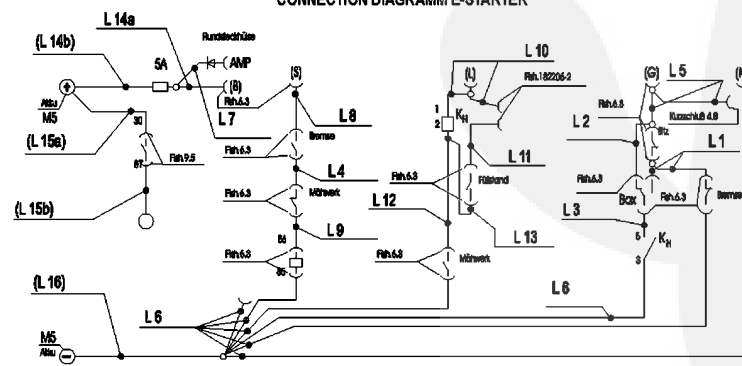

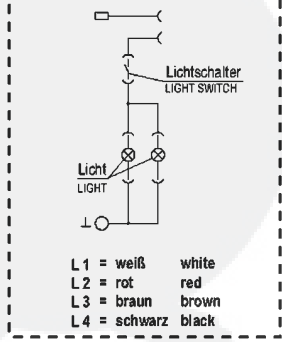

Schaltplan Licht
CONNECTION DIAGRAM LIGHT

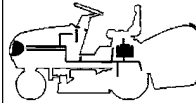

- L1 = weiß white
- L2 = rot red
- L3 = braun brown
- L4 = schwarz black

Technische Änderungen vorbehalten

22/22	RASENTRAKTOREN		ELEKTRIK 1 ELECTRIC 1 ELECTRIQUES 1	Crossover		 
2007	LAWN TRACTORS			74 / 13 Hydro - Art. 65054		
Rev070601	Tracteurs de pelouse			Modell 2007		
Bild Nr. REF.N° POS.N°	BEST.-NR. PART-N° N° d. PIECE	BEZEICHNUNG	DESCRIPTION	DÉSIGNATION	Qty.	
1	A461285	ADAPTER FÜR KABELB TEC 13 HP+13 HP B&S	ADAPTER CABLE 3 HP B&S	ADAPTEUR CABLAGES	1	
2	A514246	KABELBAUM LICHT	CABLES ASSY.	ENS. CABLAGES POUR PHARES	1	
3	A514473	SICHERUNG 5A	FUSE 5A	FUSIBLE 5A	1	
4	A521353	DIODE 5A IN5408 T ET	DIODE 5A	DIODE 5A	1	
5	A521361	STARTERRELAIS 12V/100AMPERE	STARTER RELAY	RELAIS D'ALL.	1	
6	A521362	KABELBAUM E-START 74/82	CABLES ASS.Y	ENS. CABLAGES	1	
7	A521363	KABEL ROT STARTER/RELAIS	CABLE RED	CABLES ROUGE	1	
8	A521365	KABEL BLAU MASSELEITER	CABLE BLUE	CABLES BLEU	1	
9	A521366	KABEL ROT BATTERIE/RELAIS	CABLE BATTERY-RELAIS	CABLES BATTERIE-RELAIS	1	

