

Retain for future reference

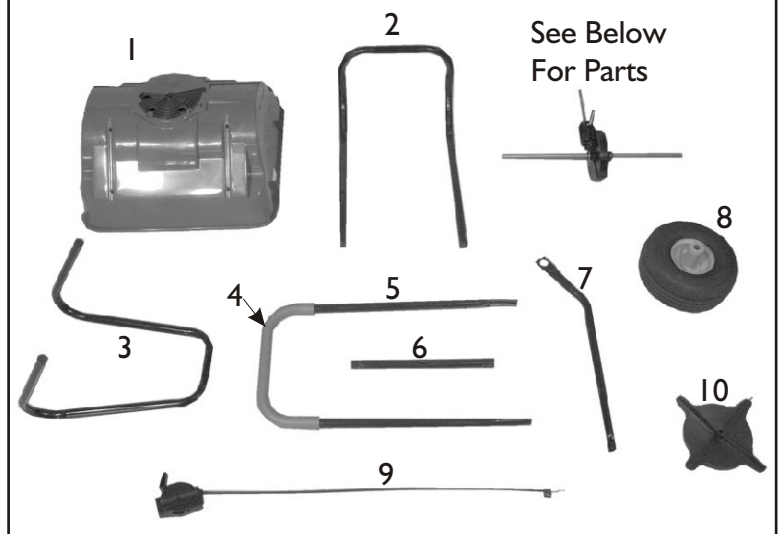

MADE IN
☆☆☆☆☆
USA



See Below
For Parts

Parts referenced with ** have two color options.

TIP: Many of these hardware parts can be purchased at your local hardware store.

CUSTOMER SUPPORT
At Precision Products, Inc. delivering quality, value and outstanding service is our goal. However, sometimes parts do become damaged or lost during transport from our facilities to the store. **If you have any problems, please do not return this merchandise to the store. Call us and we will take care of any problem you may have with this unit.**
Phone (800) 225-5891 Ext. 204

HOW TO ORDER REPLACEMENT PARTS:
When ordering parts always give model number, part number and part description.

Send To: Parts Division
316 Limit Street
Lincoln, IL 62656

Phone (800) 225-5891
(217) 735-1590 Ext. 204
FAX (217) 735-2435
www.precisionprodinc.com

Ref No	Parts No	Description	Qty
1	2877	Hopper	1
2	2908B	Wrap-Around Support (Black)	1
**	2908GY	Wrap-Around Support (Gray)	
3	2887	Leg Stand (Black)	1
**	2887G	Leg Stand (Gray)	
4	2554	Foam Handle Cover	1
5	2888B	Handle (Black)	1
**	2888GY	Handle (Gray)	
6	2546B	Cross Brace (Black)	1
**	2546G	Cross Brace (Gray)	
7	2900B	Support (Black)	2
**	2900GY	Support (Gray)	
8	3467	Wheel	2
9	2441	Control Cable	1
10	2614	Spinner Disc	1
11	2576	3/16" x 2" Cotter Pin	1
12	4466	1/4 x 3-1/2 Hex Head Bolt	4
13	1868	1/4 x 2-1/4 Carriage Bolt	3
14	6129	1/4 x 1-1/2 Hex Head Bolt	2
15	2582	Tube Cap	2
16	1270	1/4 Hex Nut	6
17	2828	Wing Nut	3
18	1042	Hitch Pin Clip	1
19	3333	5/8 Retaining Ring	1
20	1646	5/8 Washer	3
21	1817	1/4 Flat Washer	4
22	6214	5/8 Wheel Bushing	2
23	2174	3/8 Retaining Ring	1
24	2879A	Spinner Shaft Assembly	1
25	2978	7/8 Spring Clamp	1
26	2973	3/8 Nylon Bushing	3
27	2983	1/4 - 28 Grease Zerk	1
28	2976	Rear Gear Case Housing	1
29	2984	1/4 - 28 x 1/2 Long Hex Bolt	1
30	1807	1/4 Lock Washer	1
31	2977	15/16 Spring Clamp	2
32	2970	5/8 Nylon Bushing	2
33	2971	Drive Gear	1
34	2571	Axle	1
35	2975	Front Gear Case Housing	1
36	2979	3/16 x 1-1/4 Split Pin	1
**	2906	Rain Cover (Not Shown)	1

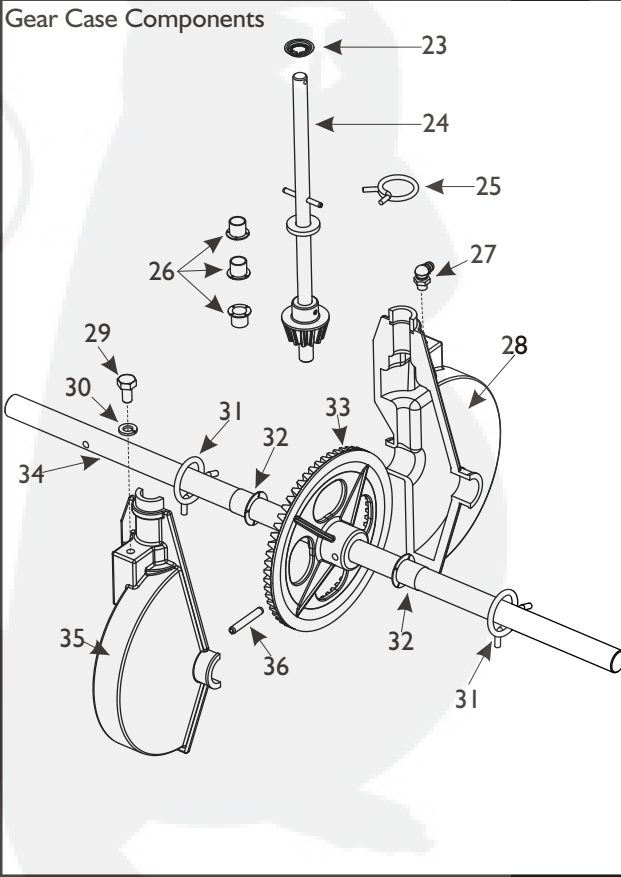
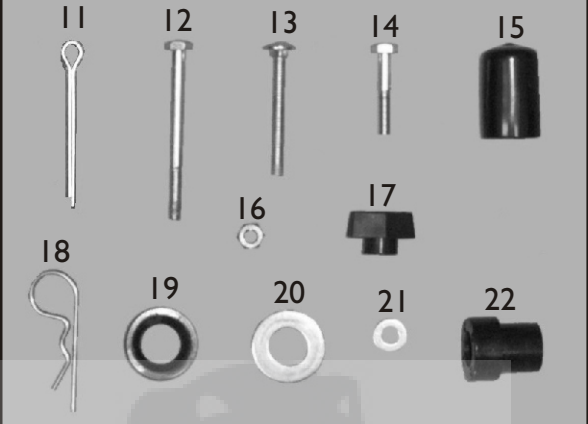

USING YOUR SB4500PRC & SB4500PRCGY BROADCAST SPREADER

STEP 1

Un-fold Handle and tighten Wing Nuts on the Handle.



FOR STORAGE

Loosen the two Wing Nuts and fold handle under hopper.

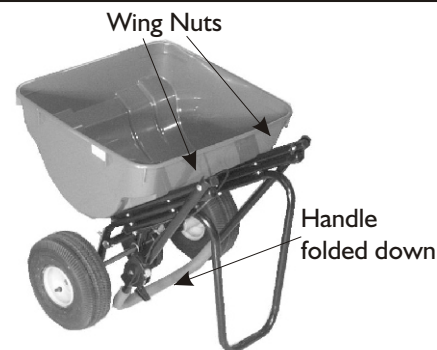

USING YOUR SPREADERS CONTROLLER

Settings are made by pushing down on the Calibration Indicator button and setting to the desired number on the Control Cable assembly.

SEE APPLICATION CHART FOR SETTING INFORMATION.

ON -- Push the Control Lever forward until it stops against Calibration Button.

OFF -- Pull Control Lever back until it stops.

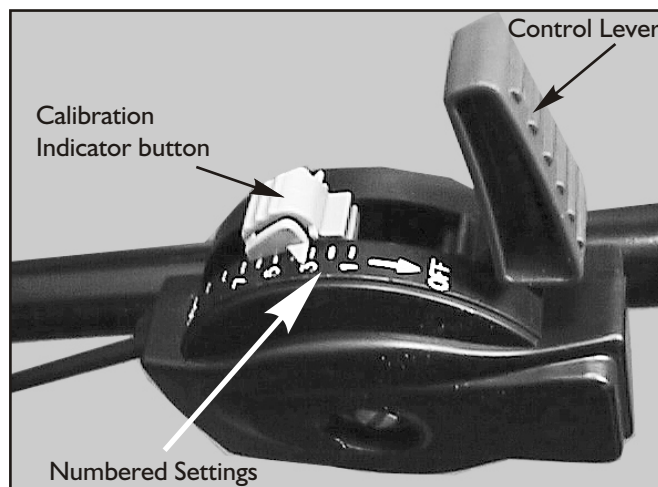

BROADCAST SPREADER OPERATION

1. Always have the control lever in OFF position before filling the hopper.
2. Always push the spreader forward to operate; do not pull backwards.
3. Start walking forward before pushing the control lever to the ON position. Pull the control lever to OFF position before stopping or turning.

DO NOT allow spreader to sit stationary with material in the hopper and control lever in the ON position.

4. Hold the handle at a height that will keep the hopper level.

5. Push the spreader at a steady, brisk pace (approximately 3 mph is recommended).
6. To avoid misses or striping, space each pass across the lawn so approximately 20% of the spread width overlaps onto the previous pass. This provides a "feathered" overlap to even out distribution over the width of the spread.

CAUTION: care must be taken with any weed killer, pesticide, or combination product. They can be harmful to other plant life in the yard.

Recommended operating weight – 90 lbs.

MAINTENANCE INSTRUCTIONS

1. Empty hopper after each use. Do not store spreader with material left in hopper.
2. Wash spreader thoroughly and wipe dry.
3. Lubricate all moving parts. Use a grease gun to apply grease to the gearbox assembly. **CAUTION: Use a reasonable amount of grease. DO NOT pack gearbox full of grease.** Apply oil to spinner shaft (including area shaft extends through hopper), slide plate and where the spinner shaft and axle extend through the gearbox.

LIMITED WARRANTY

This unit is warranted against defects in materials and workmanship to the original purchaser, under normal use and service, for a period of ninety (90) days from date of sale. During the Warranty Period, we will repair or replace at our option free of charge to the original purchaser, any part of the Unit that our examination shows to be defective in workmanship or materials. This Warranty **Does Not** apply to damage caused by transit, misuse, abuse, neglect, accident, normal wear, or alterations by unauthorized persons.